

DotBox

MADE IN ITALY

Open unit

W 800 x D 410 x H 217 mm

V1 ○ white RAL 9010 art.6D0200030 S711

V2 ● silk grey RAL 7044 art.6D0200030 7044

DESIGNER Hangar Design Group

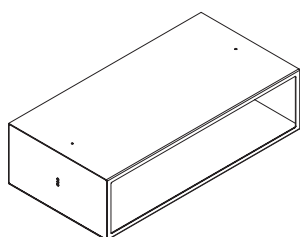

Front



Side

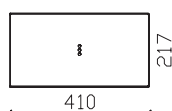

Back



DotBox

MADE IN ITALY

Open unit

W 800 x D 410 x H 217 mm

DESIGNER Hangar Design Group

DESCRIPTION	Modular system	COLORS	<ul style="list-style-type: none"> > Available in 2 standard colors > Standard semi-gloss colors > Customizable colors available upon request and with an extra charge www.dieffebi.com/docs/299/2832/DFB_Colour-Chart-2020.pdf www.dieffebi.com/it/news
EXTERNAL DIMENSIONS	W 800 mm x D 410 mm x H 217 mm		
INTERNAL DIMENSIONS	W 765 mm x D 405 mm x H 185 mm		
PRODUCTION	<ul style="list-style-type: none"> > Dieffebi S.p.a. > Start of production: 2013 > Country of production: Italy 	ACCESSORIES	<ul style="list-style-type: none"> > White lacquered glass top RAL 9010 > External fabric panel available in 7 standard colors: green, grey, black, light blue, light beige, orange, yellow > External wooden panel > Panel fixing: with adhesive
MAINTENANCE	<ul style="list-style-type: none"> > Clean with a soft cloth > Do not treat the surfaces with abrasive cloths 	NET WEIGHT	13,50 Kg
MATERIALS	> Structure made of recycled and recyclable metal	PACKAGING	<ul style="list-style-type: none"> > volume: 0,12 m³ > recycled and recyclable cardboard > Multiple on pallets > Optimized for transport with CO2 reduction > Supplied: Assembled > No. of packages: 1
FINISHING	<ul style="list-style-type: none"> > Low-emission powder coating (material inert) > Free from heavy metals > Absence of sharp edges and cutting edges > Anti-glare finish > It does not contain VOCs 	END OF USE	> Equipped with disassembly card for disposal
STANDARD COMPONENTS	> Screws for fixing between modules	WARRANTY	> Dieffebi guarantees that the product was made using high quality materials - See warranty document

DotBox

MADE IN ITALY

Open unit
W 800 x D 410 x H 217 mm

DESIGNER Hangar Design Group

WELLNESS AND ENVIRONMENT > Green design in accordance with LEED® standards, to design and furnish environments with a high sustainability content



www.GreenTop.com

ASSEMBLY CONSTRAINTS > Compositions:

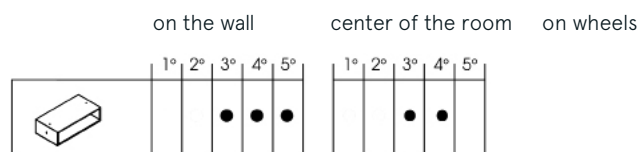

METAL TEST

- > UNI EN ISO 2409:2013
- > EN ISO 1520:2006
- > NSS UNI EN ISO 9227:2017
- > UNI 9300:2015
- > UNI EN 15187:2007
- > UNI EN ISO 6272-1:2013
- > EN 12720:2013
- > UNI EN 15185:2011
- > EN 12721:2013
- > UNI EN 15186:2012, met.B
- > UNI 9429:2015

CLASS OF REACTION TO FIRE > Class 0

POSITIONING > Both on the wall and in the center of the room

MODULARITY > Vertical and horizontal

> Composition: example wall composition

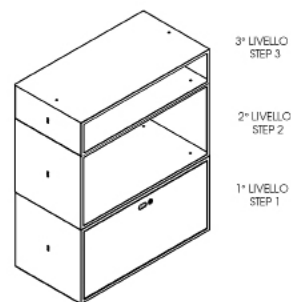

DotBox

MADE IN ITALY

Varnish
Vernici
Vernis
Lacke

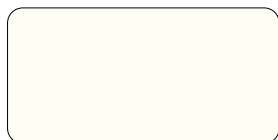
Cabinet Body
Corpo
Caisson
Korpus**-V1**
S711 (RAL 9010)
Pure white**-V2**
7044 (RAL 7044)
Silk grey

Wood
Legno
Bois
Holz

External wooden panel
Pannello esterno in legno
Panneau extérieur en bois
Außenpaneel aus Holz**- W2**
Castagno chiaro
/Light chestnut
/Châtaignier clair
/Kastanienholz hell

Glass
Vetro
Verre
Glas

Laccato
Lacquer
Laqué
LackiertTop
Piano
Plateau
Tischplatte**-G1**
Bianco/White/Blanc/Weiß

DotBox

MADE IN ITALY

Fabrics
Tessuti
Tissus
Textilien

External panel
Pannello esterno
Panneau extérieur
Außenpaneel



— T3
8009
Jet, Fidivi

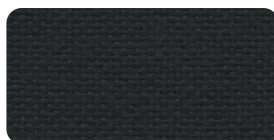

— T4
8033
Jet, Fidivi



— T7
213
Divina MD, Kvadrat

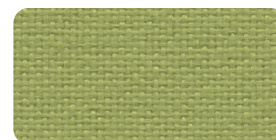

— T12
7041
Jet, Fidivi

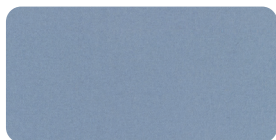

— T18
701
Hero, Kvadrat

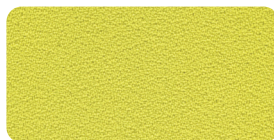

— T24
462
Mirage, Pugi · PG



— T31
133
Mirage, Pugi · PG

DotBox

MADE IN ITALY

Open unit
W 800 x D 410 x H 400/413 mm

V1	○ white	RAL 9010	art.6D0200010 S711
V2	● silk grey	RAL 7044	art.6D0200010 7044

DESIGNER Hangar Design Group

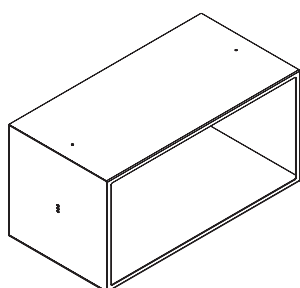

Front

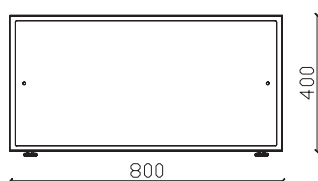

Side

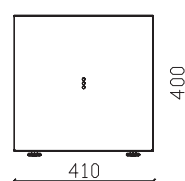

Back

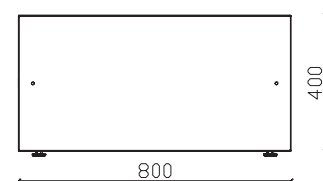

Feet detail

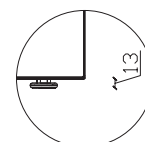

DotBox

MADE IN ITALY

Open unit

W 800 x D 410 x H 400/413 mm

DESIGNER Hangar Design Group

DESCRIPTION	Modular system
EXTERNAL DIMENSIONS	W 800 mm x D 410 mm x H 400/413 mm
INTERNAL DIMENSIONS	W 765 mm x D 405 mm x H 368 mm
BINDERS	Capacity: N°9
PRODUCTION	<ul style="list-style-type: none"> > Dieffebi S.p.a. > Start of production: 2013 > Country of production: Italy
MAINTENANCE	<ul style="list-style-type: none"> > Clean with a soft cloth > Do not treat the surfaces with abrasive cloths
MATERIALS	> Structure made of recycled and recyclable metal
FINISHING	<ul style="list-style-type: none"> > Low-emission powder coating (material inert) > Free from heavy metals > Absence of sharp edges and cutting edges > Anti-glare finish > It does not contain VOCs
STANDARD COMPONENTS	<ul style="list-style-type: none"> > Nylon feet H 13mm > Screws for fixing between modules

COLORS	<ul style="list-style-type: none"> > Available in 2 standard colors > Standard semi-gloss colors > Customizable colors available upon request and with an extra charge <p>www.dieffebi.com/docs/299/2832/DFB_Colour-Chart-2020.pdf</p> <p>www.dieffebi.com/it/news</p>
ACCESSORIES	<ul style="list-style-type: none"> > White lacquered glass top RAL 9010 > Internal metal panels available in 4 standard colors: green, blue, red, yellow > External fabric panel available in 7 standard colors: green, grey, black, light blue, light beige, orange, yellow > External wooden panel > Panel fixing: with adhesive > Cushions in M1 class fireproof fabric available in 7 standard colors: green, gray, black, light blue, light beige, orange, yellow > Chromed leveling feet h 110 mm > Set of 4 castors without brake - ø 65 mm > Set of 4 castors with brake - ø 65 mm
NET WEIGHT	15,90 Kg
PACKAGING	<ul style="list-style-type: none"> > volume: 0,19 m³ > recycled and recyclable cardboard > Multiple on pallets > Optimized for transport with CO2 reduction > Supplied: Assembled > No. of packages: 1
END OF USE	> Equipped with disassembly card for disposal
WARRANTY	> Dieffebi guarantees that the product was made using high quality materials - See warranty document

DotBox

MADE IN ITALY

Open unit
W 800 x D 410 x H 400/413 mm

DESIGNER Hangar Design Group

WELLNESS AND ENVIRONMENT > Green design in accordance with LEED® standards, to design and furnish environments with a high sustainability content



ASSEMBLY CONSTRAINTS > Compositions:
on the wall center of the room on wheels

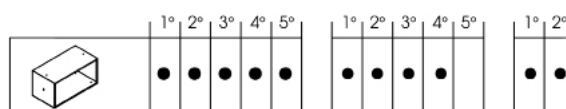

STRUCTURE TEST > CATAS laboratory
ANSI/BIFMA X5.9-2012, CLAUSE 20

> Composition: example wall composition

METAL TEST > UNI EN ISO 2409:2013 > EN ISO 1520:2006
> NSS UNI EN ISO 9227:2017 > UNI 9300:2015
> UNI EN 15187:2007 > UNI EN ISO 6272-1:2013
> EN 12720:2013 > UNI EN 15185:2011
> EN 12721:2013 > UNI EN 15186:2012, met.B
> UNI 9429:2015

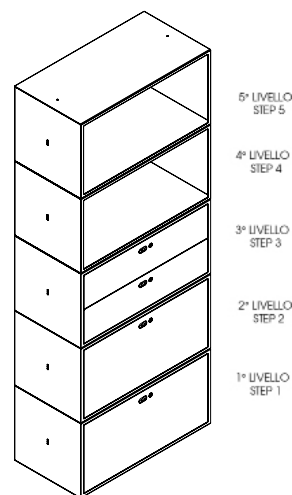

CLASS OF REACTION TO FIRE > Class 0

POSITIONING > Both on the wall and in the center of the room

MODULARITY > Vertical and horizontal



DotBox

MADE IN ITALY

Varnish
Vernici
Vernis
Lacke

Cabinet Body
Corpo
Caisson
Korpus

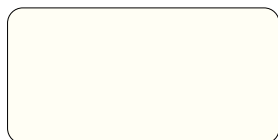

-V1
S711 (RAL 9010)
Pure white



-V2
7044 (RAL 7044)
Silk grey

Metal coloured panel
Pannello interno
in metallo colorato
Panneau Interne
en métal coloré
arbiges Metallpaneel



- V8
6013 (RAL 6013)
Reed green



- V15
1021 (RAL 1021)
Rape yellow



-V17
5024 (RAL 5024)
Pastel blue



-V24
3005 (RAL 3005)
Wine red

Wood
Legno
Bois
Holz

External wooden panel
Pannello esterno in legno
Panneau extérieur en bois
Außenpaneel aus Holz



- W2
Castagno chiaro
/Light chestnut
/Châtaignier clair
/Kastanienholz hell

Glass
Vetro
Verre
Glas

Lacquer
Laccato
Laqué
Lackiert

Top
Piano
Plateau
Tischplatte



-G1
Bianco/White/Blanc/Weiß

DotBox

MADE IN ITALY

Fabrics
Tessuti
Tissus
Textilien

External panel
Pannello esterno
Panneau extérieur
Außenpaneel



- T3
8009
Jet, Fidivi

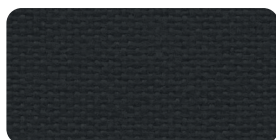

- T4
8033
Jet, Fidivi



-T7
213
Divina MD, Kvadrat

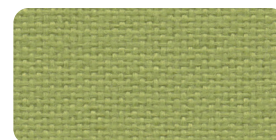

-T12
7041
Jet, Fidivi

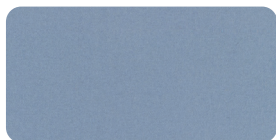

- T18
701
Hero, Kvadrat



- T24
462
Mirage, Pugi · PG



-T31
133
Mirage, Pugi · PG

DotBox

MADE IN ITALY

Open unit with shelf

V1  white RAL 9010 art.6D0200040 S711

W 800 x D 410 x H 800/813 mm

V2  silk grey RAL 7044 art.6D0200040 7044

DESIGNER Hangar Design Group

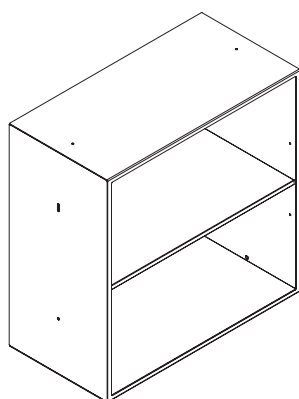

Front

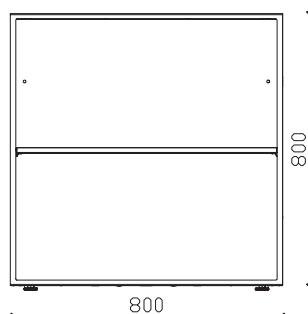

Side

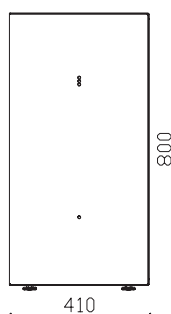

Back

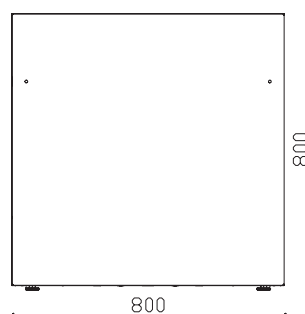

Feet detail

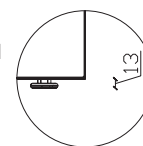

DotBox

MADE IN ITALY

Open unit with shelf
W 800 x D 410 x H 800/813 mm

DESIGNER Hangar Design Group

DESCRIPTION	Modular system
EXTERNAL DIMENSIONS	W 800 mm x D 410 mm x H 800/813 mm
INTERNAL DIMENSIONS	W 765 mm x D 405 mm x H 375(x2) mm
BINDERS	Capacity: N°18
PRODUCTION	<ul style="list-style-type: none"> > Dieffebi S.p.a. > Start of production: 2013 > Country of production: Italy
MAINTENANCE	<ul style="list-style-type: none"> > Clean with a soft cloth > Do not treat the surfaces with abrasive cloths
MATERIALS	> Structure made of recycled and recyclable metal
FINISHING	<ul style="list-style-type: none"> > Low-emission powder coating (material inert) > Free from heavy metals > Absence of sharp edges and cutting edges > Anti-glare finish > It does not contain VOCs
STANDARD COMPONENTS	<ul style="list-style-type: none"> > Nylon feet H 13mm > Screws for fixing between modules

COLORS	<ul style="list-style-type: none"> > Available in 2 standard colors > Standard semi-gloss colors > Customizable colors available upon request and with an extra charge <p>www.dieffebi.com/docs/299/2832/DFB_Colour-Chart-2020.pdf</p> <p>www.dieffebi.com/it/news</p>
---------------	--

ACCESSORIES	<ul style="list-style-type: none"> > White lacquered glass top RAL 9010 > Internal metal panels available in 4 standard colors: green, blue, red, yellow > External fabric panel available in 7 standard colors: green, grey, black, light blue, light beige, orange, yellow > Panel fixing: with adhesive > Chromed leveling feet h 110 mm > Set of 4 castors without brake - ø 65 mm > Set of 4 castors with brake - ø 65 mm
--------------------	--

NET WEIGHT	31,00 Kg
-------------------	----------

PACKAGING	<ul style="list-style-type: none"> > volume: 0,35 m³ > recycled and recyclable cardboard > Multiple on pallets > Optimized for transport with CO2 reduction > Supplied: Assembled > No. of packages: 1
------------------	---

END OF USE	> Equipped with disassembly card for disposal
-------------------	---

WARRANTY	> Dieffebi guarantees that the product was made using high quality materials - See warranty document
-----------------	--

DotBox

MADE IN ITALY

Open unit with shelf

W 800 x D 410 x H 800/813 mm

DESIGNER Hangar Design Group

WELLNESS AND ENVIRONMENT

> Green design in accordance with LEED® standards, to design and furnish environments with a high sustainability content



www.GreenTop.com

STRUCTURE TEST

> CATAS laboratory

ANSI/BIFMA X5.9-2012, CLAUSE 20

METAL TEST

> UNI EN ISO 2409:2013 > EN ISO 1520:2006
 > NSS UNI EN ISO 9227:2017 > UNI 9300:2015
 > UNI EN 15187:2007 > UNI EN ISO 6272-1:2013
 > EN 12720:2013 > UNI EN 15185:2011
 > EN 12721:2013 > UNI EN 15186:2012, met.B
 > UNI 9429:2015

CLASS OF

> Classe 0

REACTION TO FIRE

POSITIONING

> Both on the wall and in the center of the room

MODULARITY

> Vertical and horizontal

ASSEMBLY CONSTRAINTS

> Compositions:

on the wall

center of the room

on wheels

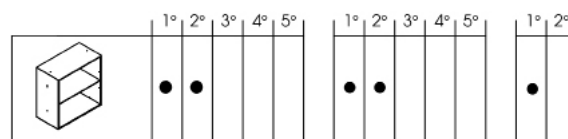

> Composition: example

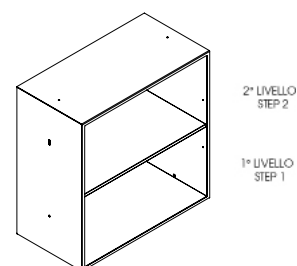

dieffebi



MADE IN EUROPE

ASSUFFICIO
ASSOCIAZIONE FIDELIENEGARRECO

ADIMEMBER

consip
acquistinretepa.it
Il Fornitore Aggiunto della Pubblica Amministrazione

Dieffebi SpA

T +39 0438 4715
 F +39 0438 471600
 exportsales@dieffebi.com
 vendite@dieffebi.com
 www.dieffebi.com

DotBox

MADE IN ITALY

Varnish
Vernici
Vernis
Lacke

Cabinet Body
Corpo
Caisson
Korpus

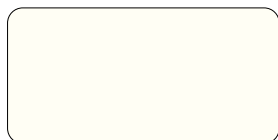

-V1
S711 (RAL 9010)
Pure white



-V2
7044 (RAL 7044)
Silk grey

Metal coloured panel
Pannello interno
in metallo colorato
Panneau Interne
en métal coloré
arbiges Metallpaneel



- V8
6013 (RAL 6013)
Reed green



- V15
1021 (RAL 1021)
Rape yellow



-V17
5024 (RAL 5024)
Pastel blue



-V24
3005 (RAL 3005)
Wine red

Glass
Vetro
Verre
Glas

Lacquer
Laccato
Laqué
Lackiert

Top
Piano
Plateau
Tischplatte



-G1
Bianco/White/Blanc/Weiß

DotBox

MADE IN ITALY

Fabrics
Tessuti
Tissus
Textilien

External panel
Pannello esterno
Panneau extérieur
Außenpaneel



- T3
8009
Jet, Fidivi

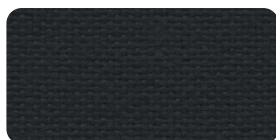

- T4
8033
Jet, Fidivi



-T7
213
Divina MD, Kvadrat



-T12
7041
Jet, Fidivi

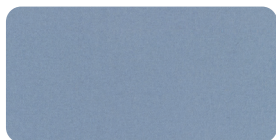

- T18
701
Hero, Kvadrat



- T24
462
Mirage, Pugi · PG



-T31
133
Mirage, Pugi · PG

DotBox

MADE IN ITALY

Open unit
W 400 x D 410 x H 400/413 mm

V1	○ white	RAL 9010	art.6D0400020 S711
V2	● silk grey	RAL 7044	art.6D0400020 7044

DESIGNER Hangar Design Group

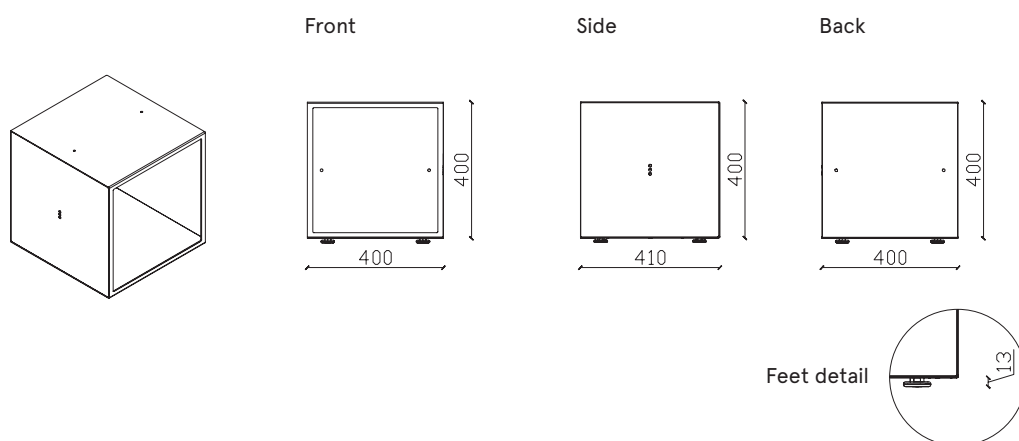

DotBox

MADE IN ITALY

Open unit

W 400 x D 410 x H 400/413 mm

DESIGNER Hangar Design Group

DESCRIPTION	Modular system
EXTERNAL DIMENSIONS	W 400 mm x D 410 mm x H 400/413 mm
INTERNAL DIMENSIONS	W 365 mm x D 365 mm x H 405 mm
BINDERS	N°4
PRODUCTION	<ul style="list-style-type: none"> > Dieffebi S.p.a. > Start of production: 2013 > Country of production: Italy
MAINTENANCE	<ul style="list-style-type: none"> > Clean with a soft cloth > Do not treat the surfaces with abrasive cloths
MATERIALS	> Structure made of recycled and recyclable metal
FINISHING	<ul style="list-style-type: none"> > Low-emission powder coating (material inert) > Free from heavy metals > Absence of sharp edges and cutting edges > Anti-glare finish > It does not contain VOCs
STANDARD COMPONENTS	<ul style="list-style-type: none"> > Nylon feet H 13mm > Screws for fixing between modules

COLORS	<ul style="list-style-type: none"> > Available in 2 standard colors > Standard semi-gloss colors > Customizable colors available upon request and with an extra charge <p>www.dieffebi.com/docs/299/2832/DFB_Colour-Chart-2020.pdf</p> <p>www.dieffebi.com/it/news</p>
ACCESSORIES	<ul style="list-style-type: none"> > White lacquered glass top RAL 9010 > Cushions in M1 class fireproof fabric available in 7 standard colors: green, gray, black, light blue, light beige, orange, yellow > Chromed leveling feet h 110 mm > Set of 4 castors without brake - ø 65 mm > Set of 4 castors with brake - ø 65 mm
NET WEIGHT	9,50 Kg
PACKAGING	<ul style="list-style-type: none"> > volume: 0,10 m³ > recycled and recyclable cardboard > Multiple on pallets > Optimized for transport with CO2 reduction > Supplied: Assembled > No. of packages: 1
END OF USE	> Equipped with disassembly card for disposal
WARRANTY	> Dieffebi guarantees that the product was made using high quality materials - See warranty document

DotBox

MADE IN ITALY

Open unit

W 400 x D 410 x H 400/413 mm

DESIGNER Hangar Design Group

WELLNESS AND ENVIRONMENT

> Green design in accordance with LEED® standards, to design and furnish environments with a high sustainability content



www.GreenTop.com



METAL TEST

> UNI EN ISO 2409:2013 > EN ISO 1520:2006
 > NSS UNI EN ISO 9227:2017 > UNI 9300:2015
 > UNI EN 15187:2007 > UNI EN ISO 6272-1:2013
 > EN 12720:2013 > UNI EN 15185:2011
 > EN 12721:2013 > UNI EN 15186:2012, met.B
 > UNI 9429:2015

CLASS OF

> Class 0

REACTION TO

FIRE

POSITIONING

> Both on the wall and in the center of the room

MODULARITY

> Vertical and horizontal

ASSEMBLY CONSTRAINTS

> Compositions:

on the wall

center of the room

on wheels

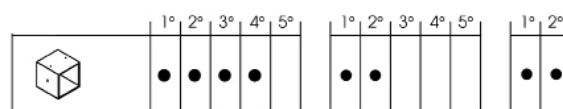

> Composition: example

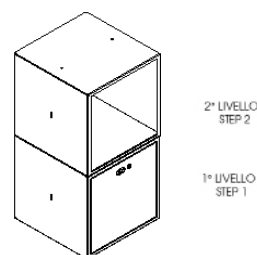

dieffebi



MADE IN EUROPE

ASSUFFICIO
ASSOCIAZIONE FIDELIENSDARREDO

ADIMEMBER

consip
acquistinretepa.it
Il Fornitore Aggiuntivo della Pubblica Amministrazione

DotBox

MADE IN ITALY

Varnish
Vernici
Vernis
Lacke

Cabinet Body
Corpo
Caisson
Korpus

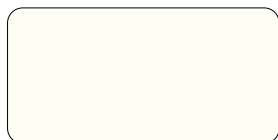

-V1
S711 (RAL 9010)
Pure white



-V2
7044 (RAL 7044)
Silk grey

Glass
Vetro
Verre
Glas

Lacquer
Laccato
Laqué
Lackiert

Top
Piano
Plateau
Tischplatte



-G1
Bianco/White/Blanc/Weiß

Fabrics
Tessuti
Tissus
Textilien

Cushion
Cuscino
Coussin
Sitzkissen



- T3
8009
Jet, Fidivi

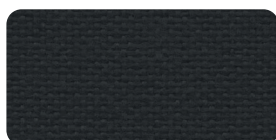

- T4
8033
Jet, Fidivi



-T7
213
Divina MD, Kvadrat

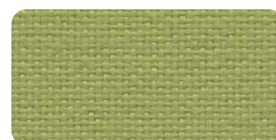

-T12
7041
Jet, Fidivi

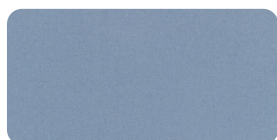

- T18
701
Hero, Kvadrat



- T24
462
Mirage, Pugi · PG



-T31
133
Mirage, Pugi · PG