

## DotBox

MADE IN ITALY

Unità a giorno V1  bianco RAL 9010 art.6D0400020 S711  
L 400 x P 410 x H 400/413 mm V2  tortora RAL 7044 art.6D0400020 7044

DESIGNER Hangar Design Group

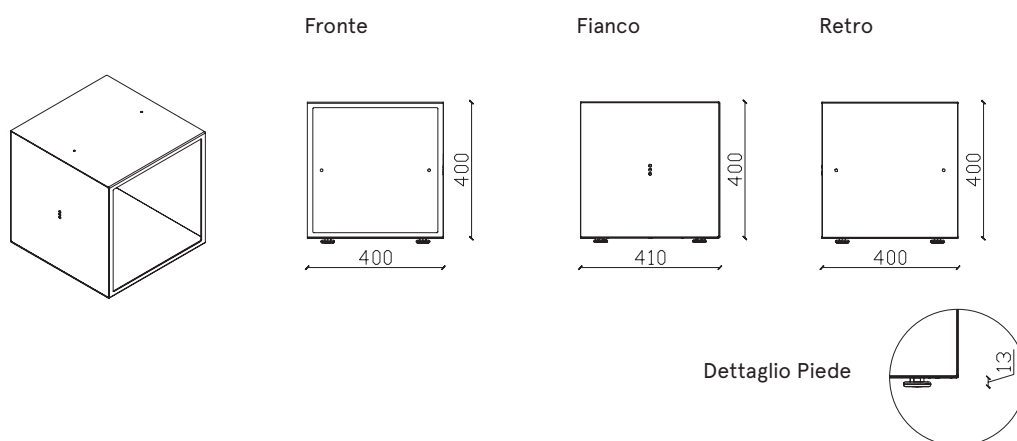

## DotBox

MADE IN ITALY

Unità a giorno

L 400 x P 410 x H 400/413 mm

DESIGNER Hangar Design Group

**DESCRIZIONE** Sistema modulare**DIMENSIONI** L 400 mm x P 410 mm x H 400/413 mm**ESTERNE****DIMENSIONI** L 365 mm x P 365 mm x H 405 mm**INTERNE VANO****DOX** Capienza Dox N°4**PRODUZIONE**

- > Dieffebi S.p.a.
- > Inizio produzione: anno 2013
- > Luogo di produzione: Italia

**MANUTENZIONE**

- > Pulire con panno morbido.
- > Non trattare le superfici con panni abrasivi.

**MATERIALI** > struttura: in metallo riciclato e riciclabile**FINITURA**

- > Verniciatura a polveri basso emissive (materiale inerte)
- > Esenti da metalli pesanti
- > Assenza di spigoli vivi e bordi taglienti
- > Finitura anti riflesso
- > Non contiene VOC

**COMPONENTI STANDARD**

- > Piedini in Nylon 13mmH
- > Viti per fissaggio tra moduli

**COLORI**

- > Disponibile in 2 colori standard
- > Colori standard semilucidi
- > Colori personalizzabili su richiesta previa disponibilità e con sovrapprezzo:  
[www.dieffebi.com/docs/299/2832/DFB\\_Colour-Chart-2020.pdf](http://www.dieffebi.com/docs/299/2832/DFB_Colour-Chart-2020.pdf).
- [www.dieffebi.com/it/news](http://www.dieffebi.com/it/news)

**ACCESSORI**

- > Top in vetro laccato bianco RAL 9010
- > Cuscini in tessuto ignifugo classe M1 disponibili in 7 colori standard: verde, grigio, nero, azzurro, beige chiaro, arancio, giallo
- > Piedini cromati livellatori h 110 mm
- > 4 Ruote piroettanti da  $\varnothing$  65 mm - con freno
- > 4 Ruote piroettanti da  $\varnothing$  65 mm - senza freno

**PESO NETTO** 9,50 Kg**IMBALLO**

- > volume: 0,10 m<sup>3</sup>
- > In cartone riciclato e riciclabile
- > Multiplo su pallet
- > Ottimizzato per il trasporto con riduzione di CO2
- > Fornito: Montato
- > N°colli: 1

**END OF USE** > Corredato di scheda di disassemblaggio per smaltimento.**GARANZIA** > Dieffebi garantisce che il prodotto è stato realizzato usando materiali di alta qualità - Vedi documento di garanzia.

## DotBox

MADE IN ITALY

Unità a giorno

L 400 x P 410 x H 400/413 mm

DESIGNER Hangar Design Group

BENESSERE E  
AMBIENTE

> Design "green" in accordo con gli standard LEED®, per progettare ed arredare ambienti ad alto contenuto di sostenibilità.



www.GreenTop.com

VINCOLI  
ASSEMBLAGGIO

&gt; Composizioni:

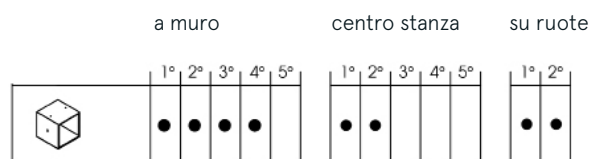

&gt; Composizione: esempio

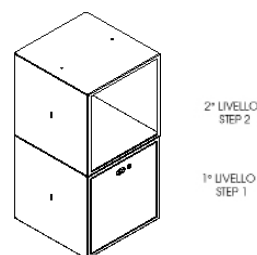

## TEST FINITURA

- > UNI EN ISO 2409:2013
- > EN ISO 1520:2006
- > NSS UNI EN ISO 9227:2017
- > UNI 9300:2015
- > UNI EN 15187:2007
- > UNI EN ISO 6272-1:2013
- > EN 12720:2013
- > UNI EN 15185:2011
- > EN 12721:2013
- > UNI EN 15186:2012, met.B
- > UNI 9429:2015

## CLASSE DI

&gt; Classe 0

REAZIONE AL  
FUOCO

POSIZIONAMENTO &gt; Sia a muro che in centro stanza

## MODULARITÀ

&gt; Verticale e orizzontale



dieffebi



MADE IN EUROPE

ASSUFFICIO  
ASSOCIAZIONE FIDELIENSDARRECO

ADIMEMBER

consip  
acquistinretepa.it

## DotBox

MADE IN ITALY

Vernici  
Varnish  
Vernis  
Lacke

Corpo  
Cabinet Body  
Caisson  
Korpus

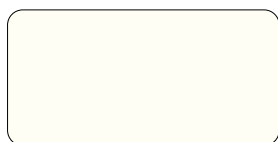

-V1  
S711 (RAL 9010)  
Pure white



-V2  
7044 (RAL 7044)  
Silk grey

Vetro  
Glass  
Verre  
Glas

Laccato  
Lacquer  
Laqué  
Lackiert

Piano  
Top  
Plateau  
Tischplatte



-G1  
Bianco/White/Blanc/Weiß

Tessuti  
Fabrics  
Tissus  
Textilien

Cuscino  
Cushion  
Cousin  
Sitzkissen



- T3  
8009  
Jet, Fidivi

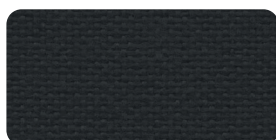

- T4  
8033  
Jet, Fidivi



-T7  
213  
Divina MD, Kvadrat

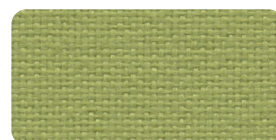

-T12  
7041  
Jet, Fidivi

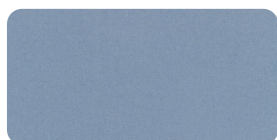

- T18  
701  
Hero, Kvadrat



- T24  
462  
Mirage, Pugi · PG



-T31  
133  
Mirage, Pugi · PG

## DotBox

MADE IN ITALY

Unità a giorno  
L 800 x P 410 x H 217 mm

V1 ○ bianco RAL 9010 art.6D0200030 S711  
V2 ● tortora RAL 7044 art.6D0200030 7044

DESIGNER Hangar Design Group

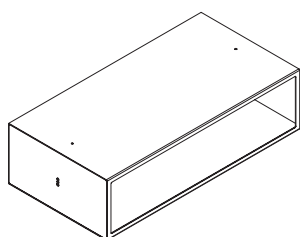

Fronte



Fianco

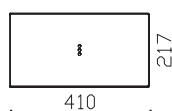

Retro



# DotBox

MADE IN ITALY

Unità a giorno  
L 800 x P 410 x H 217 mm

## DESIGNER Hangar Design Group

**DESCRIZIONE** Sistema modulare

**DIMENSIONI ESTERNE** L 800 mm x P 410 mm x H 217 mm

**DIMENSIONI INTERNE VANO** L 765 mm x P 405 mm x H 185 mm

**DOX** Non previsto

**PRODUZIONE** > Dieffebi S.p.a.  
> Inizio produzione: anno 2013  
> Luogo di produzione: Italia

**MANUTENZIONE** > Pulire con panno morbido  
> Non trattare le superfici con panni abrasivi

**MATERIALI** > struttura: in metallo riciclato e riciclabile

**FINITURA** > Verniciatura a polveri basso emissive (materiale inerte)  
> Esenti da metalli pesanti  
> Assenza di spigoli vivi e bordi taglienti  
> Finitura anti riflesso  
> Non contiene VOC

**COMPONENTI STANDARD** > Piedini non previsti  
> Viti per fissaggio tra moduli

**COLORI** > Disponibile in 2 colori standard  
> Colori standard semilucidi  
> Colori personalizzabili su richiesta previa disponibilità e con sovrapprezzo:  
[www.dieffebi.com/docs/299/2832/DFB\\_Colour-Chart-2020.pdf](http://www.dieffebi.com/docs/299/2832/DFB_Colour-Chart-2020.pdf)  
[www.dieffebi.com/it/news](http://www.dieffebi.com/it/news)

**ACCESSORI** > Top in vetro laccato bianco RAL 9010  
> Pannello esterno in tessuto disponibile in 7 colori standard: verde, grigio, nero, azzurro, beige chiaro, arancio, giallo  
> Pannello esterno in legno  
> Fissaggio pannelli: con adesivo

**PESO NETTO** 13,50 Kg

**IMBALLO** > volume: 0,12 m<sup>3</sup>  
> In cartone riciclato e riciclabile  
> Multiplo su pallet  
> Ottimizzato per il trasporto con riduzione di CO2  
> Fornito: Montato  
> N°colli: 1

**END OF USE** > Corredato di scheda di disassemblaggio per smaltimento.

**GARANZIA** > Dieffebi garantisce che il prodotto è stato realizzato usando materiali di alta qualità - Vedi documento di garanzia.

## DotBox

MADE IN ITALY

Unità a giorno  
L 800 x P 410 x H 217 mm

DESIGNER Hangar Design Group

**BENESSERE E AMBIENTE** > Design "green" in accordo con gli standard LEED®, per progettare ed arredare ambienti ad alto contenuto di sostenibilità.



**VINCOLI ASSEMBLAGGIO** > Composizioni:

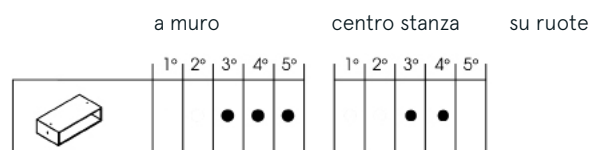

**TEST FINITURA** > UNI EN ISO 2409:2013 > EN ISO 1520:2006  
> NSS UNI EN ISO 9227:2017 > UNI 9300:2015  
> UNI EN 15187:2007 > UNI EN ISO 6272-1:2013  
> EN 12720:2013 > UNI EN 15185:2011  
> EN 12721:2013 > UNI EN 15186:2012, met.B  
> UNI 9429:2015

**CLASSE DI REAZIONE AL FUOCO** > Classe 0

**POSIZIONAMENTO** > Sia a muro che in centro stanza

**MODULARITÀ** > Verticale e orizzontale

> Composizione: esempio composizione a muro

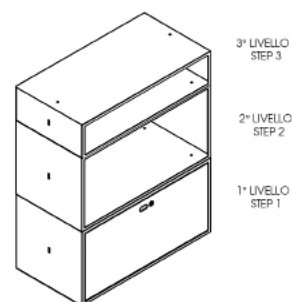

ADIMEMBER



## DotBox

MADE IN ITALY

Vernici  
Varnish  
Vernis  
Lacke

Corpo  
Cabinet Body  
Caisson  
Korpus

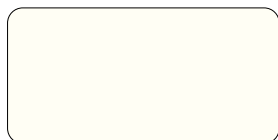

-V1  
S711 (RAL 9010)  
Pure white



-V2  
7044 (RAL 7044)  
Silk grey

Legno  
Wood  
Bois  
Holz

Pannello esterno in legno  
External wooden panel  
Panneau extérieur en bois  
Außenpaneel aus Holz



- W2  
Castagno chiaro  
/Light chestnut  
/Châtaignier clair  
/Kastanienholz hell

Vetro  
Glass  
Verre  
Glas

Laccato  
Lacquer  
Laqué  
Lackiert

Piano  
Top  
Plateau  
Tischplatte



-G1  
Bianco/White/Blanc/Weiß



## DotBox

MADE IN ITALY

Tessuti  
Fabrics  
Tissus  
Textilien

Pannello esterno  
External panel  
Panneau extérieur  
Außenpaneel



— T3  
8009  
Jet, Fidivi

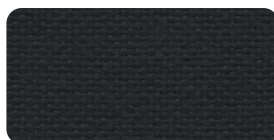

— T4  
8033  
Jet, Fidivi



—T7  
213  
Divina MD, Kvadrat



—T12  
7041  
Jet, Fidivi

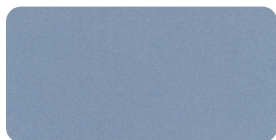

— T18  
701  
Hero, Kvadrat

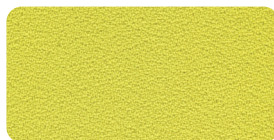

— T24  
462  
Mirage, Pugi · PG





—T31  
133  
Mirage, Pugi · PG

## DotBox

MADE IN ITALY

Unità a giorno  
L 800 x P 410 x H 400/413 mm

V1  bianco RAL 9010 art.6D0200010 S711  
V2  tortora RAL 7044 art.6D0200010 7044

DESIGNER Hangar Design Group

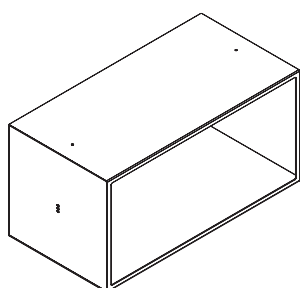

Fronte

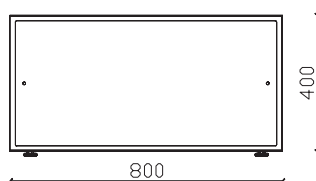

Fianco

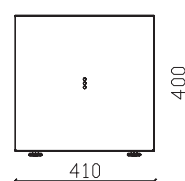

Retro

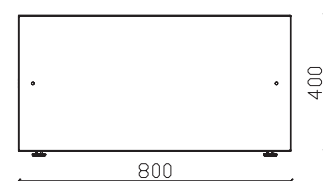

Dettaglio Piede

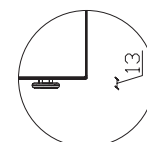

## DotBox

MADE IN ITALY

Unità a giorno

L 800 x P 410 x H 400/413

DESIGNER Hangar Design Group

DESCRIZIONE Sistema modulare

DIMENSIONI L 800 mm x P 410 mm x H 400/413 mm

ESTERNE

DIMENSIONI L 765 mm x P 405 mm x H 368 mm

INTERNE VANO

DOX Capienza Dox N°9

PRODUZIONE > Dieffebi S.p.a.  
> Inizio produzione: anno 2013  
> Luogo di produzione: Italia

MANUTENZIONE > Pulire con panno morbido  
> Non trattare le superfici con panni abrasivi

MATERIALI &gt; struttura: in metallo riciclato e riciclabile

FINITURA > Verniciatura a polveri basso emissive (materiale inerte)  
> Esenti da metalli pesanti  
> Assenza di spigoli vivi e bordi taglienti  
> Finitura anti riflesso  
> Non contiene VOC

COMPONENTI > Piedini in Nylon 13mmH  
STANDARD > Viti per fissaggio tra moduli

COLORI > Disponibile in 2 colori standard  
> Colori standard semilucidi  
> Colori personalizzabili su richiesta previa disponibilità e con sovrapprezzo:  
[www.dieffebi.com/docs/299/2832/DFB\\_Colour-Chart-2020.pdf](http://www.dieffebi.com/docs/299/2832/DFB_Colour-Chart-2020.pdf).  
[www.dieffebi.com/it/news](http://www.dieffebi.com/it/news)

ACCESSORI > Top in vetro laccato bianco RAL 9010  
> Pannelli interni in metallo disponibile in 4 colori di serie: verde, azzurro, rosso, giallo  
> Pannelli esterni in tessuto disponibile in 7 colori standard: verde, grigio, nero, azzurro, beige chiaro, arancio, giallo  
> Pannello esterno in legno  
> Fissaggio pannelli: con adesivo  
> Cuscini in tessuto ignifugo classe M1 disponibili in 7 colori standard: verde, grigio, nero, azzurro, beige chiaro, arancio, giallo  
> Piedini cromati livellatori h 110 mm  
> 4 Ruote piroettanti da ø 65 mm - con freno  
> 4 Ruote piroettanti da ø 65 mm - senza freno

PESO NETTO 15,90 Kg

IMBALLO > volume: 0,19 m<sup>3</sup>  
> In cartone riciclato e riciclabile  
> Multiplo su pallet  
> Ottimizzato per il trasporto con riduzione di CO<sub>2</sub>  
> Fornito: Montato  
> N°colli: 1

END OF USE > Corredato di scheda di disassemblaggio per smaltimento.

GARANZIA > Dieffebi garantisce che il prodotto è stato realizzato usando materiali di alta qualità - Vedi documento di garanzia.

## DotBox

MADE IN ITALY

Unità a giorno  
L 800 x P 410 x H 400/413

DESIGNER Hangar Design Group

**BENESSERE E AMBIENTE** > Design "green" in accordo con gli standard LEED®, per progettare ed arredare ambienti ad alto contenuto di sostenibilità.



www.GreenTop.com



**VINCOLI ASSEMBLAGGIO** > Composizioni:

a muro      centro stanza      su ruote

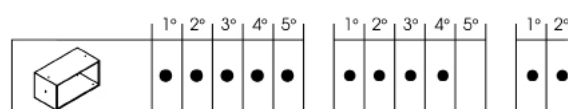

**TEST STRUTTURA** > Laboratorio CATAS  
ANSI/BIFMA X5.9-2012, CLAUSE 20

**TEST FINITURA** > UNI EN ISO 2409:2013      > EN ISO 1520:2006  
> NSS UNI EN ISO 9227:2017      > UNI 9300:2015  
> UNI EN 15187:2007      > UNI EN ISO 6272-1:2013  
> EN 12720:2013      > UNI EN 15185:2011  
> EN 12721:2013      > UNI EN 15186:2012, met.B  
> UNI 9429:2015

**CLASSE DI** > Classe 0

**REAZIONE AL FUOCO**

**POSIZIONAMENTO** > Sia a muro che in centro stanza

**MODULARITÀ** > Verticale e orizzontale

> Composizione: esempio composizione a muro

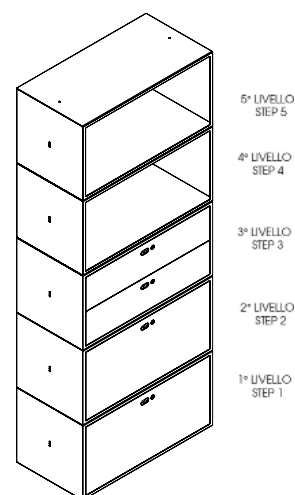

dieffebi



MADE IN EUROPE



ASSUFFICIO  
ASSOCIAZIONE FIDELIENSDARRECO

ADIMEMBER



consip  
acquistinretepa.it

## DotBox

MADE IN ITALY

Vernici  
Varnish  
Vernis  
Lacke

Corpo  
Cabinet Body  
Caisson  
Korpus

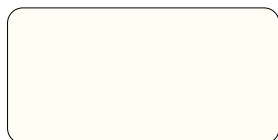

-V1  
S711 (RAL 9010)  
Pure white



-V2  
7044 (RAL 7044)  
Silk grey

Pannello interno  
in metallo colorato  
Metal coloured panel  
Panneau Interne  
en métal coloré  
arbigees Metallpaneel



- V8  
6013 (RAL 6013)  
Reed green



- V15  
1021 (RAL 1021)  
Rape yellow



-V17  
5024 (RAL 5024)  
Pastel blue



-V24  
3005 (RAL 3005)  
Wine red

Legno  
Wood  
Bois  
Holz

Pannello esterno in legno  
External wooden panel  
Panneau extérieur en bois  
Außenpaneel aus Holz



- W2  
Castagno chiaro  
/Light chestnut  
/Châtaignier clair  
/Kastanienholz hell

Vetro  
Glass  
Verre  
Glas

Laccato  
Lacquer  
Laqué  
Lackiert

Piano  
Top  
Plateau  
Tischplatte



-G1  
Bianco/White/Blanc/Weiß

## DotBox

MADE IN ITALY

Tessuti  
Fabrics  
Tissus  
Textilien

Pannello esterno  
External panel  
Panneau extérieur  
Außenpaneel



— T3  
8009  
Jet, Fidivi

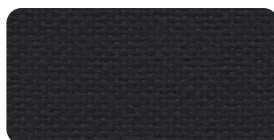

— T4  
8033  
Jet, Fidivi



— T7  
213  
Divina MD, Kvadrat

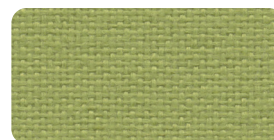

— T12  
7041  
Jet, Fidivi

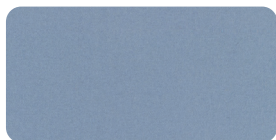

— T18  
701  
Hero, Kvadrat



— T24  
462  
Mirage, Pugi · PG



— T31  
133  
Mirage, Pugi · PG

## DotBox

MADE IN ITALY

Unità a giorno con ripiano V1  bianco RAL 9010 art.6D0200040 S711  
 L 800 x P 410 x H 800/813 mm V2  tortora RAL 7044 art.6D0200040 7044

DESIGNER Hangar Design Group

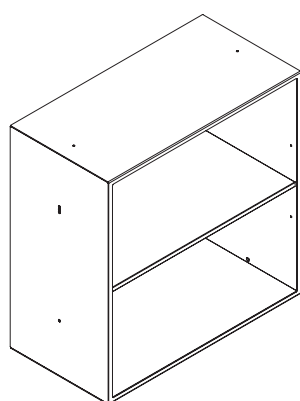

Fronte

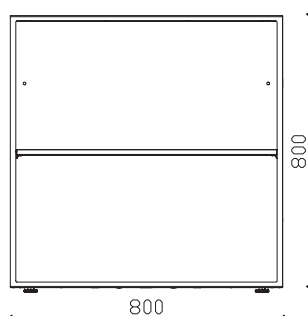

Fianco

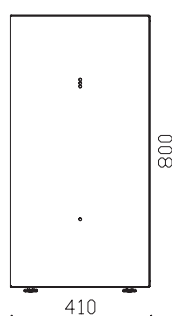

Retro

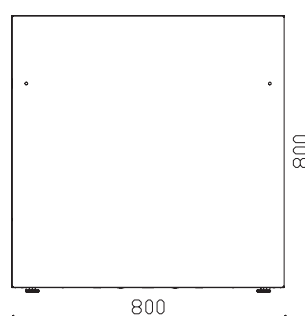

Dettaglio Piede

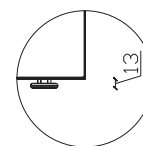

## DotBox

MADE IN ITALY

Unità a giorno con ripiano  
L 800 x P 410 x H 800/813 mm

DESIGNER Hangar Design Group

<b>DESCRIZIONE</b>	Sistema modulare	<b>COLORI</b>	<ul style="list-style-type: none"> <li>&gt; Disponibile in 2 colori standard</li> <li>&gt; Colori standard semilucidi</li> <li>&gt; Colori personalizzabili su richiesta previa disponibilità e con sovrapprezzo: <a href="http://www.dieffebi.com/docs/299/2832/DFB_Colour-Chart-2020.pdf">www.dieffebi.com/docs/299/2832/DFB_Colour-Chart-2020.pdf</a> <a href="http://www.dieffebi.com/it/news">www.dieffebi.com/it/news</a></li> </ul>
<b>DIMENSIONI ESTERNE</b>	L 800 mm x P 410 mm x H 800/813 mm	<b>ACCESSORI</b>	<ul style="list-style-type: none"> <li>&gt; Top in vetro laccato bianco RAL 9010</li> <li>&gt; Pannelli interni in metallo disponibile in 4 colori di serie: verde, azzurro, rosso, giallo</li> <li>&gt; Pannelli esterni in tessuto disponibile in 7 colori standard: verde, grigio, nero, azzurro, beige chiaro, arancio, giallo</li> <li>&gt; Fissaggio pannelli: con adesivo</li> <li>&gt; Piedini cromati livellatori h 110 mm</li> <li>&gt; 4 Ruote piroettanti da ø 65 mm - con freno</li> <li>&gt; 4 Ruote piroettanti da ø 65 mm - senza freno</li> </ul>
<b>DIMENSIONI INTERNE VANO</b>	L 765 mm x P 405 mm x H 375(x2) mm		
<b>DOX</b>	Capienza Dox N°18		
<b>PRODUZIONE</b>	<ul style="list-style-type: none"> <li>&gt; Dieffebi S.p.a.</li> <li>&gt; Inizio produzione: anno 2013</li> <li>&gt; Luogo di produzione: Italia</li> </ul>		
<b>MANUTENZIONE</b>	<ul style="list-style-type: none"> <li>&gt; Pulire con panno morbido.</li> <li>&gt; Non trattare le superfici con panni abrasivi.</li> </ul>		
<b>MATERIALI</b>	> struttura: in metallo riciclato e riciclabile		
<b>FINITURA</b>	<ul style="list-style-type: none"> <li>&gt; Verniciatura a polveri basso emissive (materiale inerte)</li> <li>&gt; Esenti da metalli pesanti</li> <li>&gt; Assenza di spigoli vivi e bordi taglienti</li> <li>&gt; Finitura anti riflesso</li> <li>&gt; Non contiene VOC</li> </ul>		
<b>COMPONENTI STANDARD</b>	<ul style="list-style-type: none"> <li>&gt; Piedini in Nylon 13mmH</li> <li>&gt; Viti per fissaggio tra moduli</li> </ul>	<b>PESO NETTO</b>	31,00 Kg
		<b>IMBALLO</b>	<ul style="list-style-type: none"> <li>&gt; volume: 0,35 m<sup>3</sup></li> <li>&gt; In cartone riciclato e riciclabile</li> <li>&gt; Multiplo su pallet</li> <li>&gt; Ottimizzato per il trasporto con riduzione di CO<sub>2</sub></li> <li>&gt; Fornito: Montato</li> <li>&gt; N°colli: 1</li> </ul>
		<b>END OF USE</b>	> Corredato di scheda di disassemblaggio per smaltimento.
		<b>GARANZIA</b>	> Dieffebi garantisce che il prodotto è stato realizzato usando materiali di alta qualità - Vedi documento di garanzia.



## DotBox

MADE IN ITALY

Unità a giorno con ripiano  
L 800 x P 410 x H 800/813 mm

DESIGNER Hangar Design Group

**BENESSERE E AMBIENTE** > Design "green" in accordo con gli standard LEED®, per progettare ed arredare ambienti ad alto contenuto di sostenibilità.



www.GreenTop.com



**VINCOLI ASSEMBLAGGIO** > Composizioni:

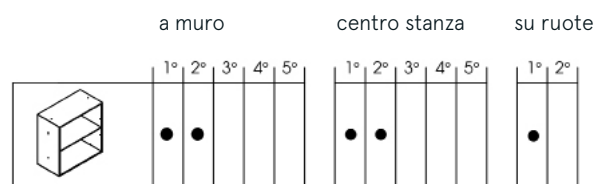

> Composizione: esempio

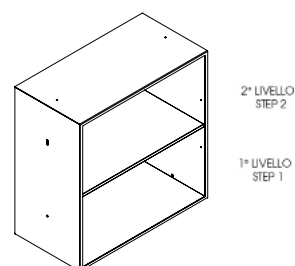

**TEST STRUTTURA** > Laboratorio CATAS  
ANSI/BIFMA X5.9-2012, CLAUSE 20

**TEST FINITURA** > UNI EN ISO 2409:2013 > EN ISO 1520:2006  
> NSS UNI EN ISO 9227:2017 > UNI 9300:2015  
> UNI EN 15187:2007 > UNI EN ISO 6272-1:2013  
> EN 12720:2013 > UNI EN 15185:2011  
> EN 12721:2013 > UNI EN 15186:2012, met.B  
> UNI 9429:2015

**CLASSE DI** > Classe 0

**REAZIONE AL FUOCO**

**POSIZIONAMENTO** > Sia a muro che in centro stanza

**MODULARITÀ** > Verticale e orizzontale



dieffebi



MADE IN EUROPE



ASSUFFICIO  
ASSOCIAZIONE FIDELIENEGARRECCI

ADIMEMBER



consip  
acquistinretepa.it

## DotBox

MADE IN ITALY

Vernici  
Varnish  
Vernis  
Lacke

Corpo  
Cabinet Body  
Caisson  
Korpus

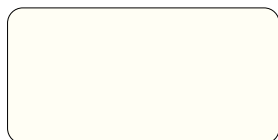

-V1  
S711 (RAL 9010)  
Pure white



-V2  
7044 (RAL 7044)  
Silk grey

Pannello interno  
in metallo colorato  
Metal coloured panel  
Panneau Interne  
en métal coloré  
arbiges Metallpaneel



- V8  
6013 (RAL 6013)  
Reed green



- V15  
1021 (RAL 1021)  
Rape yellow



-V17  
5024 (RAL 5024)  
Pastel blue



-V24  
3005 (RAL 3005)  
Wine red

Vetro  
Glass  
Verre  
Glas

Laccato  
Lacquer  
Laqué  
Lackiert

Piano  
Top  
Plateau  
Tischplatte



-G1  
Bianco/White/Blanc/Weiß

## DotBox

MADE IN ITALY

Tessuti  
Fabrics  
Tissus  
Textilien

Pannello esterno  
External panel  
Panneau extérieur  
Außenpaneel



— T3  
8009  
Jet, Fidivi

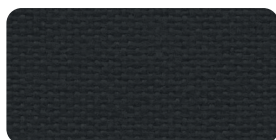

— T4  
8033  
Jet, Fidivi



— T7  
213  
Divina MD, Kvadrat

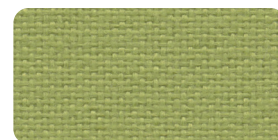

— T12  
7041  
Jet, Fidivi

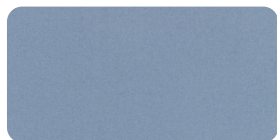

— T18  
701  
Hero, Kvadrat



— T24  
462  
Mirage, Pugi · PG



— T31  
133  
Mirage, Pugi · PG