

## Primo Sliding Doors

MADE IN ITALY

Armadio anta scorrevole L 1200  
L 1200 x P 450 x H 723 mm

Struttura: metallo

V1 ○ bianco RAL 9010

art.6PSCK101Z S711

V6 ● alluminio RAL 9006

art.6PSCK101Z S380

V22 ● nero RAL 9005

art.6PSCK101Z S811

DESIGNER Takiro Yuta

Fronte

Fianco

Retro

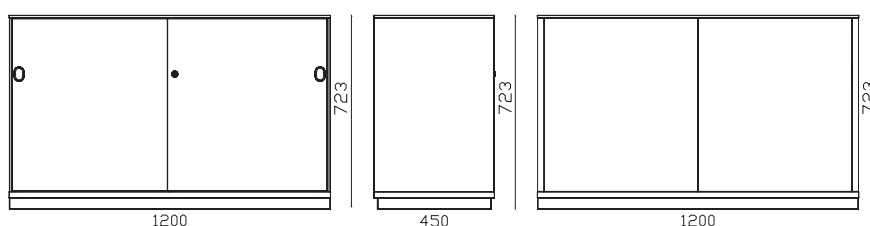
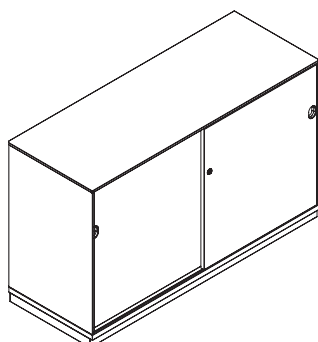

## Primo Sliding Doors

MADE IN ITALY

Armadio anta scorrevole L 1200  
L1200 x P 450 x H 723 mm

DESIGNER Takiro Yuta

<b>DESCRIZIONE</b>	Armadio Contenitore ante scorrevoli
<b>DIMENSIONI ESTERNE</b>	L 1200 mm x P 450 mm x H 723 mm
<b>DIMENSIONI INTERNE VANO</b>	L 1146 x P 388 mm x H 633 mm
<b>DOX</b>	Capienza Dox N°13
<b>CARTELLINE</b>	Capienza 105 cartelline
<b>PRODUZIONE</b>	<ul style="list-style-type: none"> <li>&gt; Dieffebi S.p.a.</li> <li>&gt; Inizio produzione: anno 2018</li> <li>&gt; Luogo di produzione: Italia</li> </ul>
<b>MANUTENZIONE</b>	<ul style="list-style-type: none"> <li>&gt; Pulire con panno morbido</li> <li>&gt; Non trattare le superfici con panni abrasivi</li> </ul>
<b>MATERIALI</b>	> struttura e ante: in metallo riciclato e riciclabile
<b>FINITURA</b>	<ul style="list-style-type: none"> <li>&gt; Verniciatura a polveri basso emissive (materiale inerte)</li> <li>&gt; Esenti da metalli pesanti</li> <li>&gt; Assenza di spigoli vivi e bordi taglienti</li> <li>&gt; Finitura anti riflesso</li> <li>&gt; Non contiene VOC</li> </ul>
<b>COMPONENTI STANDARD</b>	<ul style="list-style-type: none"> <li>&gt; Serratura a cilindro con 2 chiavi (fissa +pieghevole).</li> <li>&gt; Cilindro estraibile</li> <li>&gt; Maniglia incassata</li> <li>&gt; Ripiani regolabili: in metallo predisposti per cartelle sospese.</li> <li>&gt; Portata ripiani: 50 Kg</li> <li>&gt; Piedini regolabili H 40mm</li> <li>&gt; Viti per assemblaggio</li> </ul>

<b>COLORI</b>	<ul style="list-style-type: none"> <li>&gt; Disponibile in 3 colori standard</li> <li>V1 Bianco (RAL 9010)</li> <li>V6 Alluminio (RAL 9006)</li> <li>V22 Nero (RAL9005)</li> <li>&gt; Colori standard semilucidi</li> <li>&gt; Colori personalizzabili su richiesta previa disponibilità e con sovrapprezzo: <a href="http://www.dieffebi.com/docs/299/2832/DFB_Colour-Chart-2020.pdf">www.dieffebi.com/docs/299/2832/DFB_Colour-Chart-2020.pdf</a></li> </ul>
<b>ACCESSORI</b>	<ul style="list-style-type: none"> <li>&gt; Top di finitura in vetro laccato bianco RAL 9010</li> <li>&gt; Chiave Master</li> <li>&gt; Chiave per estrazione cilindro</li> <li>&gt; Cilindro per serratura</li> <li>&gt; Ripiano aggiuntivo in metallo</li> <li>&gt; Maniglia in diversi colori</li> <li>&gt; Kit softclosing</li> <li>&gt; Cartelline sospese per ripiano armadio Lungh. 330mm</li> </ul>
<b>PESO NETTO</b>	36,7 Kg
<b>IMBALLO</b>	<ul style="list-style-type: none"> <li>&gt; volume: 0,15 m<sup>3</sup></li> <li>&gt; Film plastico in termoretaibile</li> <li>&gt; Angolari e canale in cartone</li> <li>&gt; Ottimizzato per il trasporto con riduzione di CO2</li> <li>&gt; Fornito smontato</li> <li>&gt; N°colli: 7</li> </ul>
<b>END OF USE</b>	> Corredato di scheda di disassemblaggio per smaltimento.
<b>GARANZIA</b>	> Dieffebi garantisce che il prodotto è stato realizzato usando materiali di alta qualità - <a href="#">Vedi documento di garanzia.</a>

## Primo Sliding Doors

MADE IN ITALY

Armadio anta scorrevole L 1200  
L1200 x P 450 x H 723 mm

DESIGNER Takiro Yuta

**BENESSERE E AMBIENTE** > Design "green" in accordo con gli standard LEED®, per progettare ed arredare ambienti ad alto contenuto di sostenibilità.



www.GreenTop.com



**TEST STRUTTURA** EN 14073-2:2004, par. 3.4  
EN 14073-3:2004, par. 5.2  
EN 14073-3:2004, par. 5.3.1  
EN 14073-3:2004, par. 5.3.2  
EN 14074:2004, par. 6.4.1  
EN 14074:2004, par. 6.4.2  
UNI8606:1984  
EN16122:2012 + AC:2015, par. 6.1.4

**TEST FINITURA** UNI EN ISO 2409:2013  
NSS UNI EN ISO 9227:2017  
UNI EN 15187:2007 EN ISO 1520:2006  
UNI EN ISO 6272-1:2013  
UNI EN 15185:2011  
UNI EN 15186:2012, met.B  
UNI 9300:2015  
EN 12720:2013  
EN 12721:2013  
UNI 9429:2015

**CLASSE DI REAZIONE AL FUOCO** > Classe 0

**POSIZIONAMENTO** > Sia a muro che in centro stanza



dieffebi



MADE IN EUROPE



ASSUFFICIO  
ASSOCIAZIONE FIDELIENEGARRECO

ADIMEMBER



consip  
acquistinretepa.it

Dieffebi SpA

via Palù 36  
San Vendemiano,  
31020 Treviso - Italia

T +39 0438 4715  
F +39 0438 471600  
exportsales@dieffebi.com  
vendite@dieffebi.com  
www.dieffebi.com

## Primo Sliding Doors

Vernici  
Varnish  
Vernis  
Lacke

Corpo  
Cabinet Body  
Caisson  
Korpus



**-V1**  
S711 (RAL 9010)  
Pure white



**-V6**  
S380 (RAL 9006)  
White aluminium



**-V22**  
S811 (RAL 9005)  
Jet black

Ripiano aggiuntivo  
in metallo  
Additional metal shelf  
Tablette supplémentaire  
en métal  
Zusätzlicher  
Metallfachboden



**-V1**  
S711 (RAL 9010)  
Pure white



**-V6**  
S380 (RAL 9006)  
White aluminium



**-V22**  
S811 (RAL 9005)  
Jet black

Maniglia colorata  
Coloured handle  
Poignée couleur  
Farbiger Griff



**-V8**  
6013 (RAL 6013)  
Green



**-V15**  
1021 (RAL 1021)  
Yellow



**-V17**  
5024 (RAL 5024)  
Pastel Blue



**-V19**  
S210 (RAL 7021)  
Black grey



**-V24**  
3005 (RAL 3005)  
Wine red

Vetro  
Glass  
Verre  
Glas

Top di finitura in vetro  
laccato bianco  
White lacquered glass top  
Plateau en verre laqué  
blanc  
Glasabdeckplatte weiß  
lackiert

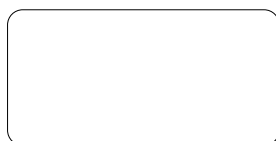

**-G1**  
Bianco/White/Blanc/Weiß

## Primo Sliding Doors

MADE IN ITALY

Armadio ad ante scorrevoli L 1600  
L 1600 x P 450 x H 723 mm

Struttura: metallo

V1 ○ bianco RAL 9010

art.6PSCK201Z S711

V6 ● alluminio RAL 9006

art.6PSCK201Z S380

V22 ● nero RAL 9005

art.6PSCK201Z S811

DESIGNER Takiro Yuta

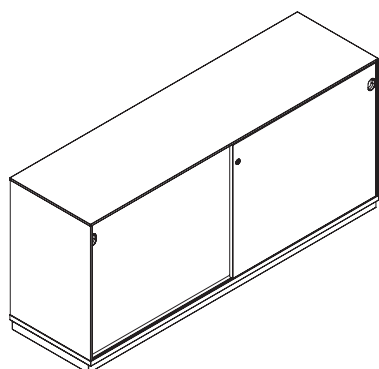

Fronte

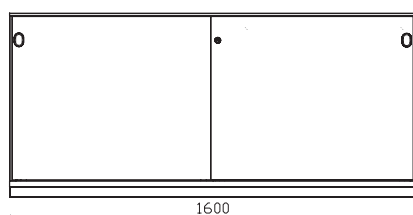

Fianco

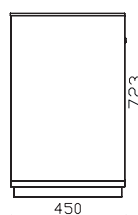

Retro

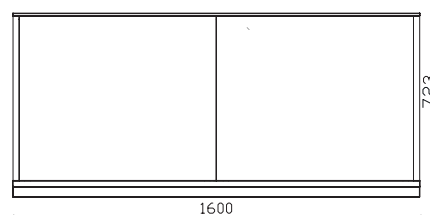

## Primo Sliding Doors

MADE IN ITALY

Armadio anta scorrevole L 1600  
L1600 x P 450 x H 723 mm

DESIGNER Takiro Yuta

<b>DESCRIZIONE</b>	Armadio Contenitore ante scorrevoli
<b>DIMENSIONI ESTERNE</b>	L 1600 mm x P 450 mm x H 723 mm
<b>DIMENSIONI INTERNE VANO</b>	2 x (L 763 mm x P 388 mm X H 633 mm)
<b>DOX</b>	Capienza Dox N°8 + 8
<b>CARTELLINE</b>	Capienza 65 + 65 cartelline
<b>PRODUZIONE</b>	<ul style="list-style-type: none"> <li>&gt; Dieffebi S.p.a.</li> <li>&gt; Inizio produzione: anno 2018</li> <li>&gt; Luogo di produzione: Italia</li> </ul>
<b>MANUTENZIONE</b>	<ul style="list-style-type: none"> <li>&gt; Pulire con panno morbido</li> <li>&gt; Non trattare le superfici con panni abrasivi</li> </ul>
<b>MATERIALI</b>	> struttura e ante: in metallo riciclato e riciclabile
<b>FINITURA</b>	<ul style="list-style-type: none"> <li>&gt; Verniciatura a polveri basso emissive (materiale inerte)</li> <li>&gt; Esenti da metalli pesanti</li> <li>&gt; Assenza di spigoli vivi e bordi taglienti</li> <li>&gt; Finitura anti riflesso</li> <li>&gt; Non contiene VOC</li> </ul>
<b>COMPONENTI STANDARD</b>	<ul style="list-style-type: none"> <li>&gt; Serratura a cilindro con 2 chiavi (fissa +pieghevole).</li> <li>&gt; Cilindro estraibile</li> <li>&gt; Maniglia incassata</li> <li>&gt; Ripiani regolabili: in metallo predisposti per cartelle sospese.</li> <li>&gt; Portata ripiani: 50 Kg</li> <li>&gt; Piedini regolabili H 40mm</li> <li>&gt; Viti per assemblaggio</li> </ul>

<b>COLORI</b>	<ul style="list-style-type: none"> <li>&gt; Disponibile in 3 colori standard</li> <li>V1 Bianco (RAL 9010)</li> <li>V6 Alluminio (RAL 9006)</li> <li>V22 Nero (RAL9005)</li> <li>&gt; Colori standard semilucidi</li> <li>&gt; Colori personalizzabili su richiesta previa disponibilità e con sovrapprezzo: <a href="http://www.dieffebi.com/docs/299/2832/DFB_Colour-Chart-2020.pdf">www.dieffebi.com/docs/299/2832/DFB_Colour-Chart-2020.pdf</a></li> </ul>
<b>ACCESSORI</b>	<ul style="list-style-type: none"> <li>&gt; Top di finitura in vetro laccato bianco RAL 9010</li> <li>&gt; Chiave Master</li> <li>&gt; Chiave per estrazione cilindro</li> <li>&gt; Cilindro per serratura</li> <li>&gt; Ripiano aggiuntivo in metallo</li> <li>&gt; Maniglia in diversi colori</li> <li>&gt; Kit softclosing</li> <li>&gt; Cartelline sospese per ripiano armadio Lungh. 330mm</li> </ul>
<b>PESO NETTO</b>	64,4 Kg
<b>IMBALLO</b>	<ul style="list-style-type: none"> <li>&gt; volume: 0,2 m<sup>3</sup></li> <li>&gt; Film plastico in termoretaibile</li> <li>&gt; Angolari e canale in cartone</li> <li>&gt; Ottimizzato per il trasporto con riduzione di CO2</li> <li>&gt; Fornito smontato</li> <li>&gt; N°colli: 8</li> </ul>
<b>END OF USE</b>	> Corredato di scheda di disassemblaggio per smaltimento.
<b>GARANZIA</b>	> Dieffebi garantisce che il prodotto è stato realizzato usando materiali di alta qualità - <a href="#">Vedi documento di garanzia.</a>

## Primo Sliding Doors

MADE IN ITALY

Armadio anta scorrevole L 1600

L1600 x P 450 x H 723 mm

DESIGNER Takiro Yuta

**BENESSERE E AMBIENTE** > Design "green" in accordo con gli standard LEED®, per progettare ed arredare ambienti ad alto contenuto di sostenibilità.



www.GreenTop.com



**TEST STRUTTURA** EN 14073-2:2004, par. 3.4  
 EN 14073-3:2004, par. 5.2  
 EN 14073-3:2004, par. 5.3.1  
 EN 14073-3:2004, par. 5.3.2  
 EN 14074:2004, par. 6.4.1  
 EN 14074:2004, par. 6.4.2  
 UNI8606:1984  
 EN16122:2012 + AC:2015, par. 6.1.4"

**TEST FINITURA** UNI EN ISO 2409:2013  
 NSS UNI EN ISO 9227:2017  
 UNI EN 15187:2007 EN ISO 1520:2006  
 UNI EN ISO 6272-1:2013  
 UNI EN 15185:2011  
 UNI EN 15186:2012, met.B  
 UNI 9300:2015  
 EN 12720:2013  
 EN 12721:2013  
 UNI 9429:2015

**CLASSE DI REAZIONE AL FUOCO** > Classe 0

**POSIZIONAMENTO** > Sia a muro che in centro stanza



dieffebi



MADE IN EUROPE



ASSUFFICIO  
 ASSOCIAZIONE FEDERLEGGIDARREDI

ADIMEMBER



consip  
 acqustinretepa.it  
Il Fornitore degli Appalti Pubblici per l'edilizia

Dieffebi SpA

3 via Palù 36  
 San Vendemiano,  
 31020 Treviso - Italia

T +39 0438 4715  
 F +39 0438 471600  
 exportsales@dieffebi.com  
 vendite@dieffebi.com  
 www.dieffebi.com

29 06 2021

## Primo Sliding Doors

Vernici  
Varnish  
Vernis  
Lacke

Corpo  
Cabinet Body  
Caisson  
Korpus



**-V1**  
S711 (RAL 9010)  
Pure white



**-V6**  
S380 (RAL 9006)  
White aluminium



**-V22**  
S811 (RAL 9005)  
Jet black

Ripiano aggiuntivo  
in metallo  
Additional metal shelf  
Tablette supplémentaire  
en métal  
Zusätzlicher  
Metallfachboden



**-V1**  
S711 (RAL 9010)  
Pure white



**-V6**  
S380 (RAL 9006)  
White aluminium



**-V22**  
S811 (RAL 9005)  
Jet black

Maniglia colorata  
Coloured handle  
Poignée couleur  
Farbiger Griff



**-V8**  
6013 (RAL 6013)  
Green



**-V15**  
1021 (RAL 1021)  
Yellow



**-V17**  
5024 (RAL 5024)  
Pastel Blue

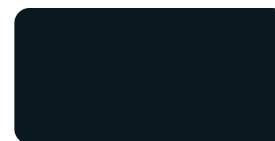

**-V19**  
S210 (RAL 7021)  
Black grey



**-V24**  
3005 (RAL 3005)  
Wine red

Vetro  
Glass  
Verre  
Glas

Top di finitura in vetro  
laccato bianco  
White lacquered glass top  
Plateau en verre laqué  
blanc  
Glasabdeckplatte weiß  
lackiert

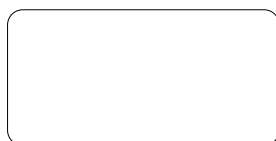

**-G1**  
Bianco/White/Blanc/Weiß



## Primo Sliding Doors

MADE IN ITALY

Armadio anta scorrevole L 2000  
L 2000 x P 450 x H 723 mm

Struttura: metallo

V1 ○ bianco RAL 9010

art.6PSCK301Z S711

V6 ● alluminio RAL 9006

art.6PSCK301Z S380

V22 ● nero RAL 9005

art.6PSCK301Z S811

DESIGNER Takiro Yuta

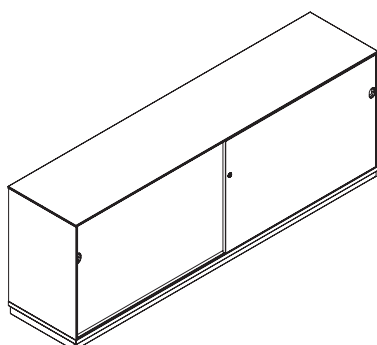

Fronte

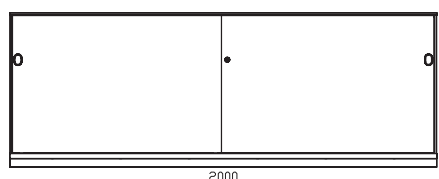

Fianco

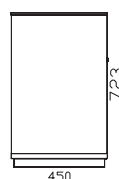

Retro

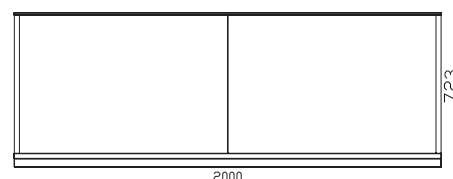

## Primo Sliding Doors

MADE IN ITALY

Armadio anta scorrevole L 2000  
L 2000 x P 450 x H 723 mm

DESIGNER Takiro Yuta

<b>DESCRIZIONE</b>	Armadio Contenitore ante scorrevoli
<b>DIMENSIONI ESTERNE</b>	L 2000 mm x P 450 mm x H 723 mm
<b>DIMENSIONI INTERNE VANO</b>	2 x (L 963 mm x P 388 mm x H 633 mm)
<b>DOX</b>	Capienza Dox N° 10 + 10
<b>CARTELLINE</b>	Capienza 80 + 80 cartelline
<b>PRODUZIONE</b>	<ul style="list-style-type: none"> <li>&gt; Dieffebi S.p.a.</li> <li>&gt; Inizio produzione: anno 2018</li> <li>&gt; Luogo di produzione: Italia</li> </ul>
<b>MANUTENZIONE</b>	<ul style="list-style-type: none"> <li>&gt; Pulire con panno morbido</li> <li>&gt; Non trattare le superfici con panni abrasivi</li> </ul>
<b>MATERIALI</b>	> struttura e ante: in metallo riciclato e riciclabile
<b>FINITURA</b>	<ul style="list-style-type: none"> <li>&gt; Verniciatura a polveri basso emissive (materiale inerte)</li> <li>&gt; Esenti da metalli pesanti</li> <li>&gt; Assenza di spigoli vivi e bordi taglienti</li> <li>&gt; Finitura anti riflesso</li> <li>&gt; Non contiene VOC</li> </ul>
<b>COMPONENTI STANDARD</b>	<ul style="list-style-type: none"> <li>&gt; Serratura a cilindro con 2 chiavi (fissa +pieghevole).</li> <li>&gt; Cilindro estraibile</li> <li>&gt; Maniglia incassata</li> <li>&gt; Ripiani regolabili: in metallo predisposti per cartelle sospese.</li> <li>&gt; Portata ripiani: 50 Kg</li> <li>&gt; Piedini regolabili H 40mm</li> <li>&gt; Viti per assemblaggio</li> </ul>

<b>COLORI</b>	<ul style="list-style-type: none"> <li>&gt; Disponibile in 3 colori standard</li> <li>V1 Bianco (RAL 9010)</li> <li>V6 Alluminio (RAL 9006)</li> <li>V22 Nero (RAL9005)</li> <li>&gt; Colori standard semilucidi</li> <li>&gt; Colori personalizzabili su richiesta previa disponibilità e con sovrapprezzo: <a href="http://www.dieffebi.com/docs/299/2832/DFB_Colour-Chart-2020.pdf">www.dieffebi.com/docs/299/2832/DFB_Colour-Chart-2020.pdf</a></li> </ul>
<b>ACCESSORI</b>	<ul style="list-style-type: none"> <li>&gt; Top di finitura in vetro laccato bianco RAL 9010</li> <li>&gt; Chiave Master</li> <li>&gt; Chiave per estrazione cilindro</li> <li>&gt; Cilindro per serratura</li> <li>&gt; Ripiano aggiuntivo in metallo</li> <li>&gt; Maniglia in diversi colori</li> <li>&gt; Kit softclosing</li> <li>&gt; Cartelline sospese per ripiano armadio Lungh. 330mm</li> </ul>
<b>PESO NETTO</b>	66,00 Kg
<b>IMBALLO</b>	<ul style="list-style-type: none"> <li>&gt; volume: 0,22 m<sup>3</sup></li> <li>&gt; Film plastico in termoretaibile</li> <li>&gt; Angolari e canale in cartone</li> <li>&gt; Ottimizzato per il trasporto con riduzione di CO2</li> <li>&gt; Fornito smontato</li> <li>&gt; N°colli: 8</li> </ul>
<b>END OF USE</b>	> Corredato di scheda di disassemblaggio per smaltimento.
<b>GARANZIA</b>	> Dieffebi garantisce che il prodotto è stato realizzato usando materiali di alta qualità - <a href="#">Vedi documento di garanzia.</a>

## Primo Sliding Doors

MADE IN ITALY

Armadio anta scorrevole L 2000

L 2000 x P 450 x H 723 mm

DESIGNER Takiro Yuta

**BENESSERE E AMBIENTE** > Design "green" in accordo con gli standard LEED®, per progettare ed arredare ambienti ad alto contenuto di sostenibilità.



www.GreenTop.com



**TEST STRUTTURA** EN 14073-2:2004, par. 3.4  
 EN 14073-3:2004, par. 5.2  
 EN 14073-3:2004, par. 5.3.1  
 EN 14073-3:2004, par. 5.3.2  
 EN 14074:2004, par. 6.4.1  
 EN 14074:2004, par. 6.4.2  
 UNI8606:1984  
 EN16122:2012 + AC:2015, par. 6.1.4"

**TEST FINITURA** UNI EN ISO 2409:2013  
 NSS UNI EN ISO 9227:2017  
 UNI EN 15187:2007 EN ISO 1520:2006  
 UNI EN ISO 6272-1:2013  
 UNI EN 15185:2011  
 UNI EN 15186:2012, met.B  
 UNI 9300:2015  
 EN 12720:2013  
 EN 12721:2013  
 UNI 9429:2015

**CLASSE DI REAZIONE AL FUOCO** > Classe 0

**POSIZIONAMENTO** > Sia a muro che in centro stanza



dieffebi



MADE IN EUROPE



ASSUFFICIO  
 ASSOCIAZIONE FIDELIENEGARRECO

ADIMEMBER



consip  
 acqustinretepa.it  
Il Fornitore degli Appalti Pubblici per l'edilizia

Dieffebi SpA

via Palù 36  
 San Vendemiano,  
 31020 Treviso - Italia

T +39 0438 4715  
 F +39 0438 471600  
 exportsales@dieffebi.com  
 vendite@dieffebi.com  
 www.dieffebi.com

## Primo Sliding Doors

### Vernici Varnish Vernis Lacke

Corpo  
Cabinet Body  
Caisson  
Korpus



**-V1**  
S711 (RAL 9010)  
Pure white



**-V6**  
S380 (RAL 9006)  
White aluminium

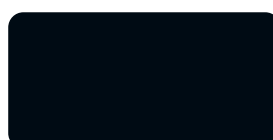

**-V22**  
S811 (RAL 9005)  
Jet black

Ripiano aggiuntivo  
in metallo  
Additional metal shelf  
Tablette supplémentaire  
en métal  
Zusätzlicher  
Metallfachboden



**-V1**  
S711 (RAL 9010)  
Pure white



**-V6**  
S380 (RAL 9006)  
White aluminium

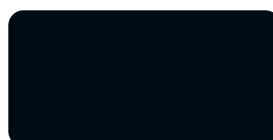

**-V22**  
S811 (RAL 9005)  
Jet black

Maniglia colorata  
Coloured handle  
Poignée couleur  
Farbiger Griff



**-V8**  
6013 (RAL 6013)  
Green



**-V15**  
1021 (RAL 1021)  
Yellow



**-V17**  
5024 (RAL 5024)  
Pastel Blue



**-V19**  
S210 (RAL 7021)  
Black grey



**-V24**  
3005 (RAL 3005)  
Wine red

### Vetro Glass Verre Glas

Top di finitura in vetro  
laccato bianco  
White lacquered glass top  
Plateau en verre laqué  
blanc  
Glasabdeckplatte weiß  
lackiert

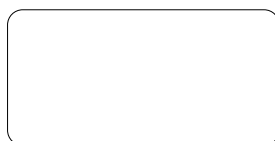

**-G1**  
Bianco/White/Blanc/Weiß

## Primo Sliding Doors

MADE IN ITALY

Armadio anta scorrevole L 1200  
L 1200 x P 450 x H 1171 mm

Struttura: metallo

V1 ○ bianco RAL 9010

art.6PSCK104Z S711

V6 ● alluminio RAL 9006

art.6PSCK104Z S380

V22 ● nero RAL 9005

art.6PSCK104Z S811

DESIGNER Takiro Yuta

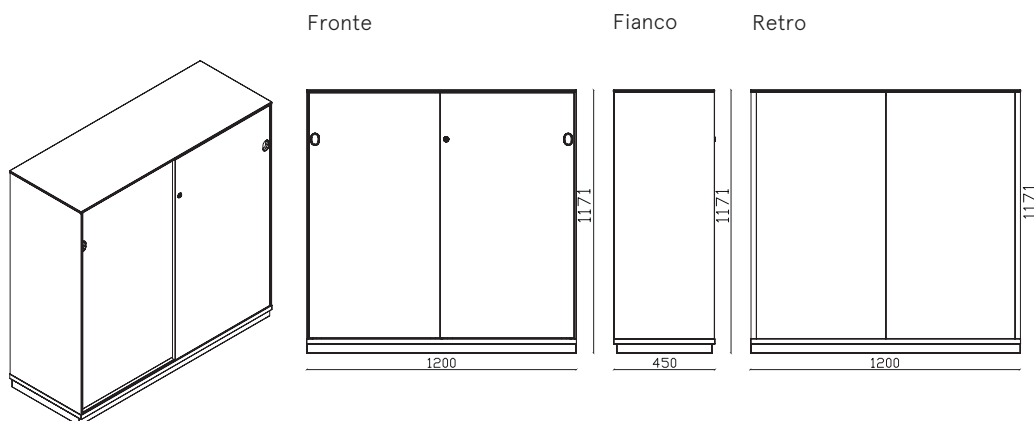

## Primo Sliding Doors

MADE IN ITALY

Armadio anta scorrevole L 1200  
L 1200 x P 450 x H 1171 mm

DESIGNER Takiro Yuta

<b>DESCRIZIONE</b>	Armadio Contenitore ante scorrevoli
<b>DIMENSIONI ESTERNE</b>	L 1200 mm x P 450 mm x H 1171 mm
<b>DIMENSIONI INTERNE VANO</b>	L 1146 mm x P 388 mm x H 1081 mm
<b>DOX</b>	Capienza Dox N° 13 (x2)
<b>CARTELLINE</b>	Capienza 105 (x2) cartelline
<b>PRODUZIONE</b>	<ul style="list-style-type: none"> <li>&gt; Dieffebi S.p.a.</li> <li>&gt; Inizio produzione: anno 2018</li> <li>&gt; Luogo di produzione: Italia</li> </ul>
<b>MANUTENZIONE</b>	<ul style="list-style-type: none"> <li>&gt; Pulire con panno morbido</li> <li>&gt; Non trattare le superfici con panni abrasivi</li> </ul>
<b>MATERIALI</b>	> struttura e ante: in metallo riciclato e riciclabile
<b>FINITURA</b>	<ul style="list-style-type: none"> <li>&gt; Verniciatura a polveri basso emissive (materiale inerte)</li> <li>&gt; Esenti da metalli pesanti</li> <li>&gt; Assenza di spigoli vivi e bordi taglienti</li> <li>&gt; Finitura anti riflesso</li> <li>&gt; Non contiene VOC</li> </ul>
<b>COMPONENTI STANDARD</b>	<ul style="list-style-type: none"> <li>&gt; Serratura a cilindro con 2 chiavi (fissa +pieghevole).</li> <li>&gt; Cilindro estraibile</li> <li>&gt; Maniglia incassata</li> <li>&gt; Ripiani regolabili: in metallo predisposti per cartelle sospese.</li> <li>&gt; Portata ripiani: 50 Kg</li> <li>&gt; Piedini regolabili H 40mm</li> <li>&gt; Viti per assemblaggio</li> </ul>

<b>COLORI</b>	<ul style="list-style-type: none"> <li>&gt; Disponibile in 3 colori standard</li> <li>V1 Bianco (RAL 9010)</li> <li>V6 Alluminio (RAL 9006)</li> <li>V22 Nero (RAL9005)</li> <li>&gt; Colori standard semilucidi</li> <li>&gt; Colori personalizzabili su richiesta previa disponibilità e con sovrapprezzo: <a href="http://www.dieffebi.com/docs/299/2832/DFB_Colour-Chart-2020.pdf">www.dieffebi.com/docs/299/2832/DFB_Colour-Chart-2020.pdf</a></li> </ul>
<b>ACCESSORI</b>	<ul style="list-style-type: none"> <li>&gt; Top di finitura in vetro laccato bianco RAL 9010</li> <li>&gt; Chiave Master</li> <li>&gt; Chiave per estrazione cilindro</li> <li>&gt; Cilindro per serratura</li> <li>&gt; Ripiano aggiuntivo in metallo</li> <li>&gt; Maniglia in diversi colori</li> <li>&gt; Kit softclosing</li> <li>&gt; Cartelline sospese per ripiano armadio Lungh. 330mm</li> </ul>
<b>PESO NETTO</b>	55,60 Kg
<b>IMBALLO</b>	<ul style="list-style-type: none"> <li>&gt; volume: 0,2 m<sup>3</sup></li> <li>&gt; Film plastico in termoretaibile</li> <li>&gt; Angolari e canale in cartone</li> <li>&gt; Ottimizzato per il trasporto con riduzione di CO2</li> <li>&gt; Fornito smontato</li> <li>&gt; N°colli: 7</li> </ul>
<b>END OF USE</b>	> Corredato di scheda di disassemblaggio per smaltimento
<b>GARANZIA</b>	> Dieffebi garantisce che il prodotto è stato realizzato usando materiali di alta qualità - <a href="#">Vedi documento di garanzia.</a>

## Primo Sliding Doors

MADE IN ITALY

Armadio anta scorrevole L 1200

L 1200 x P 450 x H 1171 mm

DESIGNER Takiro Yuta

**BENESSERE E AMBIENTE** > Design "green" in accordo con gli standard LEED®, per progettare ed arredare ambienti ad alto contenuto di sostenibilità.



www.GreenTop.com



**TEST STRUTTURA** EN 14073-2:2004, par. 3.4  
 EN 14073-3:2004, par. 5.2  
 EN 14073-3:2004, par. 5.3.1  
 EN 14073-3:2004, par. 5.3.2  
 EN 14074:2004, par. 6.4.1  
 EN 14074:2004, par. 6.4.2  
 UNI8606:1984  
 EN16122:2012 + AC:2015, par. 6.1.4"

**TEST FINITURA** UNI EN ISO 2409:2013  
 NSS UNI EN ISO 9227:2017  
 UNI EN 15187:2007 EN ISO 1520:2006  
 UNI EN ISO 6272-1:2013  
 UNI EN 15185:2011  
 UNI EN 15186:2012, met.B  
 UNI 9300:2015  
 EN 12720:2013  
 EN 12721:2013  
 UNI 9429:2015

**CLASSE DI REAZIONE AL FUOCO** > Classe 0

**POSIZIONAMENTO** > Sia a muro che in centro stanza



dieffebi



MADE IN EUROPE



ASSUFFICIO  
 ASSOCIAZIONE FIDELIENEGARRECO

ADIMEMBER



consip  
 acqustinretepa.it  
Il Fornitore degli Appalti Pubblici per l'edilizia

Dieffebi SpA

via Palù 36  
 San Vendemiano,  
 31020 Treviso - Italia

T +39 0438 4715  
 F +39 0438 471600  
 exportsales@dieffebi.com  
 vendite@dieffebi.com  
 www.dieffebi.com

## Primo Sliding Doors

Vernici  
Varnish  
Vernis  
Lacke

Corpo  
Cabinet Body  
Caisson  
Korpus



**-V1**  
S711 (RAL 9010)  
Pure white



**-V6**  
S380 (RAL 9006)  
White aluminium



**-V22**  
S811 (RAL 9005)  
Jet black

Ripiano aggiuntivo  
in metallo  
Additional metal shelf  
Tablette supplémentaire  
en métal  
Zusätzlicher  
Metallfachboden



**-V1**  
S711 (RAL 9010)  
Pure white



**-V6**  
S380 (RAL 9006)  
White aluminium



**-V22**  
S811 (RAL 9005)  
Jet black

Maniglia colorata  
Coloured handle  
Poignée couleur  
Farbiger Griff



**-V8**  
6013 (RAL 6013)  
Green



**-V15**  
1021 (RAL 1021)  
Yellow



**-V17**  
5024 (RAL 5024)  
Pastel Blue

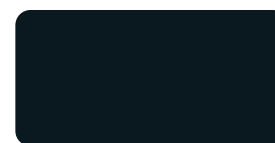

**-V19**  
S210 (RAL 7021)  
Black grey



**-V24**  
3005 (RAL 3005)  
Wine red

Vetro  
Glass  
Verre  
Glas

Top di finitura in vetro  
laccato bianco  
White lacquered glass top  
Plateau en verre laqué  
blanc  
Glasabdeckplatte weiß  
lackiert

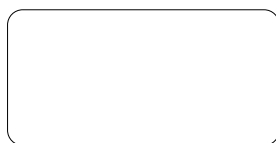

**-G1**  
Bianco/White/Blanc/Weiß



## Primo Sliding Doors

MADE IN ITALY

Armadio anta scorrevole L 1600  
L 1600 x P 450 x H 1171 mm

Struttura: metallo

V1 ○ bianco RAL 9010

art.6PSCK204Z S711

V6 ● alluminio RAL 9006

art.6PSCK204Z S380

V22 ● nero RAL 9005

art.6PSCK204Z S811

DESIGNER Takiro Yuta

Fronte

Fianco

Retro

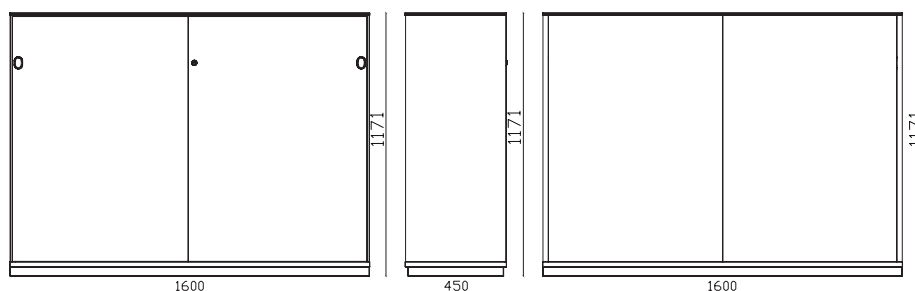
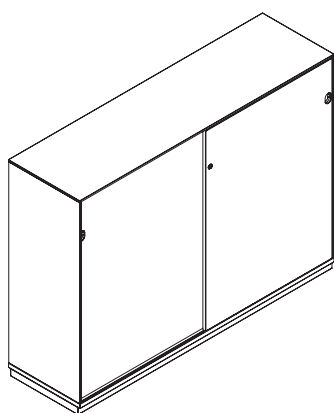

## Primo Sliding Doors

MADE IN ITALY

Armadio anta scorrevole L 1600  
L 1600 x P 450 x H 1171 mm

DESIGNER Takiro Yuta

<b>DESCRIZIONE</b>	Armadio Contenitore ante scorrevoli
<b>DIMENSIONI ESTERNE</b>	L 1600 mm x P 450 mm x H 1171 mm
<b>DIMENSIONI INTERNE VANO</b>	2 x (L 763 mm x P 388 mm x H 1081 mm)
<b>DOX</b>	Capienza Dox N° 8 (x4)
<b>CARTELLINE</b>	Capienza 65 (x4) cartelline
<b>PRODUZIONE</b>	<ul style="list-style-type: none"> <li>&gt; Dieffebi S.p.a.</li> <li>&gt; Inizio produzione: anno 2018</li> <li>&gt; Luogo di produzione: Italia</li> </ul>
<b>MANUTENZIONE</b>	<ul style="list-style-type: none"> <li>&gt; Pulire con panno morbido</li> <li>&gt; Non trattare le superfici con panni abrasivi</li> </ul>
<b>MATERIALI</b>	> struttura e ante: in metallo riciclato e riciclabile
<b>FINITURA</b>	<ul style="list-style-type: none"> <li>&gt; Verniciatura a polveri basso emissive (materiale inerte)</li> <li>&gt; Esenti da metalli pesanti</li> <li>&gt; Assenza di spigoli vivi e bordi taglienti</li> <li>&gt; Finitura anti riflesso</li> <li>&gt; Non contiene VOC</li> </ul>
<b>COMPONENTI STANDARD</b>	<ul style="list-style-type: none"> <li>&gt; Serratura a cilindro con 2 chiavi (fissa +pieghevole).</li> <li>&gt; Cilindro estraibile</li> <li>&gt; Maniglia incassata</li> <li>&gt; Ripiani regolabili: in metallo predisposti per cartelle sospese.</li> <li>&gt; Portata ripiani: 50 Kg</li> <li>&gt; Piedini regolabili H 40mm</li> <li>&gt; Viti per assemblaggio</li> </ul>

<b>COLORI</b>	<ul style="list-style-type: none"> <li>&gt; Disponibile in 3 colori standard</li> <li>V1 Bianco (RAL 9010)</li> <li>V6 Alluminio (RAL 9006)</li> <li>V22 Nero (RAL9005)</li> <li>&gt; Colori standard semilucidi</li> <li>&gt; Colori personalizzabili su richiesta previa disponibilità e con sovrapprezzo: <a href="http://www.dieffebi.com/docs/299/2832/DFB_Colour-Chart-2020.pdf">www.dieffebi.com/docs/299/2832/DFB_Colour-Chart-2020.pdf</a></li> </ul>
<b>ACCESSORI</b>	<ul style="list-style-type: none"> <li>&gt; Top di finitura in vetro laccato bianco RAL 9010</li> <li>&gt; Chiave Master</li> <li>&gt; Chiave per estrazione cilindro</li> <li>&gt; Cilindro per serratura</li> <li>&gt; Ripiano aggiuntivo in metallo</li> <li>&gt; Maniglia in diversi colori</li> <li>&gt; Kit softclosing</li> <li>&gt; Cartelline sospese per ripiano armadio Lungh. 330mm</li> </ul>
<b>PESO NETTO</b>	91,50 Kg
<b>IMBALLO</b>	<ul style="list-style-type: none"> <li>&gt; volume: 0,27 m<sup>3</sup></li> <li>&gt; Film plastico in termoretaibile</li> <li>&gt; Angolari e canale in cartone</li> <li>&gt; Ottimizzato per il trasporto con riduzione di CO2</li> <li>&gt; Fornito smontato</li> <li>&gt; N°colli: 8</li> </ul>
<b>END OF USE</b>	> Corredato di scheda di disassemblaggio per smaltimento.
<b>GARANZIA</b>	> Dieffebi garantisce che il prodotto è stato realizzato usando materiali di alta qualità - <a href="#">Vedi documento di garanzia.</a>

## Primo Sliding Doors

MADE IN ITALY

Armadio anta scorrevole L 1600

L 1600 x P 450 x H 1171 mm

DESIGNER Takiro Yuta

**BENESSERE E AMBIENTE** > Design "green" in accordo con gli standard LEED®, per progettare ed arredare ambienti ad alto contenuto di sostenibilità.



www.GreenTop.com



**TEST STRUTTURA** EN 14073-2:2004, par. 3.4  
 EN 14073-3:2004, par. 5.2  
 EN 14073-3:2004, par. 5.3.1  
 EN 14073-3:2004, par. 5.3.2  
 EN 14074:2004, par. 6.4.1  
 EN 14074:2004, par. 6.4.2  
 UNI8606:1984  
 EN16122:2012 + AC:2015, par. 6.1.4"

**TEST FINITURA** UNI EN ISO 2409:2013  
 NSS UNI EN ISO 9227:2017  
 UNI EN 15187:2007 EN ISO 1520:2006  
 UNI EN ISO 6272-1:2013  
 UNI EN 15185:2011  
 UNI EN 15186:2012, met.B  
 UNI 9300:2015  
 EN 12720:2013  
 EN 12721:2013  
 UNI 9429:2015

**CLASSE DI REAZIONE AL FUOCO** > Classe 0

**POSIZIONAMENTO** > Sia a muro che in centro stanza



dieffebi



MADE IN EUROPE



ASSUFFICIO  
 ASSOCIAZIONE FIDELIENEGARRECO

ADIMEMBER



consip  
 acqustinretepa.it  
Il Fornitore Aggiunto della Pubblica Amministrazione

## Primo Sliding Doors

Vernici  
Varnish  
Vernis  
Lacke

Corpo  
Cabinet Body  
Caisson  
Korpus



**-V1**  
S711 (RAL 9010)  
Pure white



**-V6**  
S380 (RAL 9006)  
White aluminium

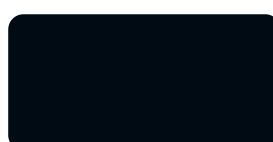

**-V22**  
S811 (RAL 9005)  
Jet black

Ripiano aggiuntivo  
in metallo  
Additional metal shelf  
Tablette supplémentaire  
en métal  
Zusätzlicher  
Metallfachboden



**-V1**  
S711 (RAL 9010)  
Pure white



**-V6**  
S380 (RAL 9006)  
White aluminium



**-V22**  
S811 (RAL 9005)  
Jet black

Maniglia colorata  
Coloured handle  
Poignée couleur  
Farbiger Griff



**-V8**  
6013 (RAL 6013)  
Green



**-V15**  
1021 (RAL 1021)  
Yellow



**-V17**  
5024 (RAL 5024)  
Pastel Blue



**-V19**  
S210 (RAL 7021)  
Black grey



**-V24**  
3005 (RAL 3005)  
Wine red

Vetro  
Glass  
Verre  
Glas

Top di finitura in vetro  
laccato bianco  
White lacquered glass top  
Plateau en verre laqué  
blanc  
Glasabdeckplatte weiß  
lackiert

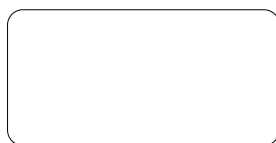

**-G1**  
Bianco/White/Blanc/Weiß

## Primo Sliding Doors

MADE IN ITALY

Armadio anta scorrevole L 2000  
L 2000 x P 450 x H 1171 mm

Struttura: metallo

V1 ○ bianco RAL 9010

art.6PSCK304Z S711

V6 ● alluminio RAL 9006

art.6PSCK304Z S380

V22 ● nero RAL 9005

art.6PSCK304Z S811

DESIGNER Takiro Yuta

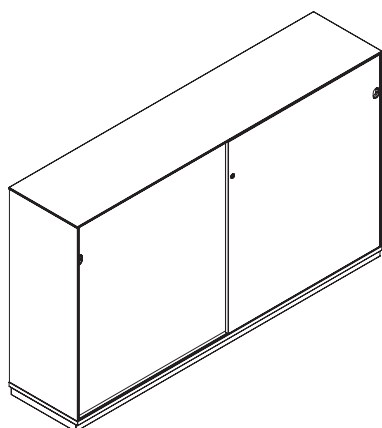

Fronte

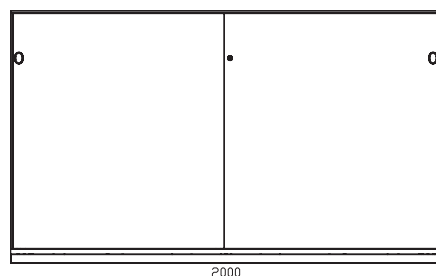

Fianco

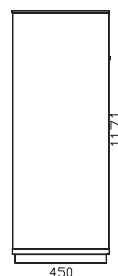

Retro

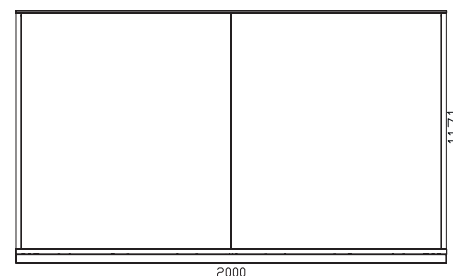

## Primo Sliding Doors

MADE IN ITALY

Armadio anta scorrevole L 2000  
L 2000 x P 450 x H 1171 mm

DESIGNER Takiro Yuta

<b>DESCRIZIONE</b>	Armadio Contenitore ante scorrevoli
<b>DIMENSIONI ESTERNE</b>	L 2000 mm x P 450 mm x H 1171 mm
<b>DIMENSIONI INTERNE VANO</b>	2 x (L 963 mm x P 388 mm x H 1081 mm)
<b>DOX</b>	Capienza Dox N° 10 (x4)
<b>CARTELLINE</b>	Capienza 80 (x4) cartelline
<b>PRODUZIONE</b>	<ul style="list-style-type: none"> <li>&gt; Dieffebi S.p.a.</li> <li>&gt; Inizio produzione: anno 2018</li> <li>&gt; Luogo di produzione: Italia</li> </ul>
<b>MANUTENZIONE</b>	<ul style="list-style-type: none"> <li>&gt; Pulire con panno morbido</li> <li>&gt; Non trattare le superfici con panni abrasivi</li> </ul>
<b>MATERIALI</b>	> struttura e ante: in metallo riciclato e riciclabile
<b>FINITURA</b>	<ul style="list-style-type: none"> <li>&gt; Verniciatura a polveri basso emissive (materiale inerte)</li> <li>&gt; Esenti da metalli pesanti</li> <li>&gt; Assenza di spigoli vivi e bordi taglienti</li> <li>&gt; Finitura anti riflesso</li> <li>&gt; Non contiene VOC</li> </ul>
<b>COMPONENTI STANDARD</b>	<ul style="list-style-type: none"> <li>&gt; Serratura a cilindro con 2 chiavi (fissa +pieghevole).</li> <li>&gt; Cilindro estraibile</li> <li>&gt; Maniglia incassata</li> <li>&gt; Ripiani regolabili: in metallo predisposti per cartelle sospese.</li> <li>&gt; Portata ripiani: 50 Kg</li> <li>&gt; Piedini regolabili H 40mm</li> <li>&gt; Viti per assemblaggio</li> </ul>

<b>COLORI</b>	<ul style="list-style-type: none"> <li>&gt; Disponibile in 3 colori standard</li> <li>V1 Bianco (RAL 9010)</li> <li>V6 Alluminio (RAL 9006)</li> <li>V22 Nero (RAL9005)</li> <li>&gt; Colori standard semilucidi</li> <li>&gt; Colori personalizzabili su richiesta previa disponibilità e con sovrapprezzo: <a href="http://www.dieffebi.com/docs/299/2832/DFB_Colour-Chart-2020.pdf">www.dieffebi.com/docs/299/2832/DFB_Colour-Chart-2020.pdf</a></li> </ul>
<b>ACCESSORI</b>	<ul style="list-style-type: none"> <li>&gt; Top di finitura in vetro laccato bianco RAL 9010</li> <li>&gt; Chiave Master</li> <li>&gt; Chiave per estrazione cilindro</li> <li>&gt; Cilindro per serratura</li> <li>&gt; Ripiano aggiuntivo in metallo</li> <li>&gt; Maniglia in diversi colori</li> <li>&gt; Kit softclosing</li> <li>&gt; Cartelline sospese per ripiano armadio Lungh. 330mm</li> </ul>
<b>PESO NETTO</b>	99,70 Kg
<b>IMBALLO</b>	<ul style="list-style-type: none"> <li>&gt; volume: 0,33 m<sup>3</sup></li> <li>&gt; Film plastico in termoretaibile</li> <li>&gt; Angolari e canale in cartone</li> <li>&gt; Ottimizzato per il trasporto con riduzione di CO2</li> <li>&gt; Fornito smontato</li> <li>&gt; N°colli: 8</li> </ul>
<b>END OF USE</b>	> Corredato di scheda di disassemblaggio per smaltimento.
<b>GARANZIA</b>	> Dieffebi garantisce che il prodotto è stato realizzato usando materiali di alta qualità - <a href="#">Vedi documento di garanzia.</a>

## Primo Sliding Doors

MADE IN ITALY

Armadio anta scorrevole L 2000

L 2000 x P 450 x H 1171 mm

DESIGNER Takiro Yuta

**BENESSERE E AMBIENTE** > Design "green" in accordo con gli standard LEED®, per progettare ed arredare ambienti ad alto contenuto di sostenibilità.



www.GreenTop.com



**TEST STRUTTURA** EN 14073-2:2004, par. 3.4  
 EN 14073-3:2004, par. 5.2  
 EN 14073-3:2004, par. 5.3.1  
 EN 14073-3:2004, par. 5.3.2  
 EN 14074:2004, par. 6.4.1  
 EN 14074:2004, par. 6.4.2  
 UNI8606:1984  
 EN16122:2012 + AC:2015, par. 6.1.4"

**TEST FINITURA** UNI EN ISO 2409:2013  
 NSS UNI EN ISO 9227:2017  
 UNI EN 15187:2007 EN ISO 1520:2006  
 UNI EN ISO 6272-1:2013  
 UNI EN 15185:2011  
 UNI EN 15186:2012, met.B  
 UNI 9300:2015  
 EN 12720:2013  
 EN 12721:2013  
 UNI 9429:2015

**CLASSE DI REAZIONE AL FUOCO** > Classe 0

**POSIZIONAMENTO** > Sia a muro che in centro stanza



dieffebi



MADE IN EUROPE



ASSUFFICIO  
 ASSOCIAZIONE FIDELIENEGARRECO

ADIMEMBER



consip  
 acqustinretepa.it  
 Il Fornitore degli Appalti Pubblici per l'edilizia  
 e l'edilizia residenziale pubblica

## Primo Sliding Doors

### Vernici Varnish Vernis Lacke

Corpo  
Cabinet Body  
Caisson  
Korpus



**-V1**  
S711 (RAL 9010)  
Pure white



**-V6**  
S380 (RAL 9006)  
White aluminium

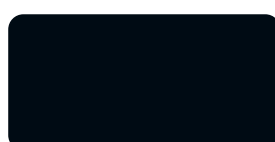

**-V22**  
S811 (RAL 9005)  
Jet black

Ripiano aggiuntivo  
in metallo  
Additional metal shelf  
Tablette supplémentaire  
en métal  
Zusätzlicher  
Metallfachboden



**-V1**  
S711 (RAL 9010)  
Pure white



**-V6**  
S380 (RAL 9006)  
White aluminium

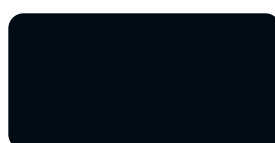

**-V22**  
S811 (RAL 9005)  
Jet black

Maniglia colorata  
Coloured handle  
Poignée couleur  
Farbiger Griff



**-V8**  
6013 (RAL 6013)  
Green



**-V15**  
1021 (RAL 1021)  
Yellow



**-V17**  
5024 (RAL 5024)  
Pastel Blue



**-V19**  
S210 (RAL 7021)  
Black grey



**-V24**  
3005 (RAL 3005)  
Wine red

### Vetro Glass Verre Glas

Top di finitura in vetro  
laccato bianco  
White lacquered glass top  
Plateau en verre laqué  
blanc  
Glasabdeckplatte weiß  
lackiert

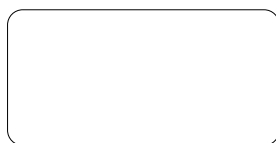

**-G1**  
Bianco/White/Blanc/Weiß



## Primo Sliding Doors

MADE IN ITALY

Armadio anta scorrevole L 1200  
L 1200 x P 450 x H 1651 mm

Struttura: metallo

V1 ○ bianco RAL 9010

art.6PSCK106Z S711

V6 ● alluminio RAL 9006

art.6PSCK106Z S380

V22 ● nero RAL 9005

art.6PSCK106Z S811

DESIGNER Takiro Yuta

Fronte

Fianco

Retro

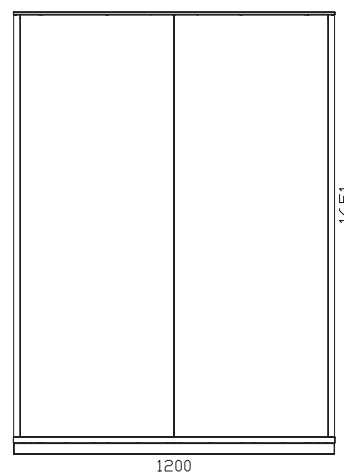
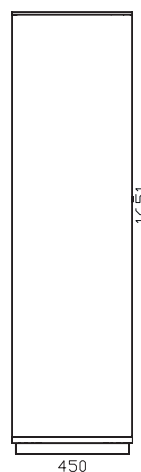
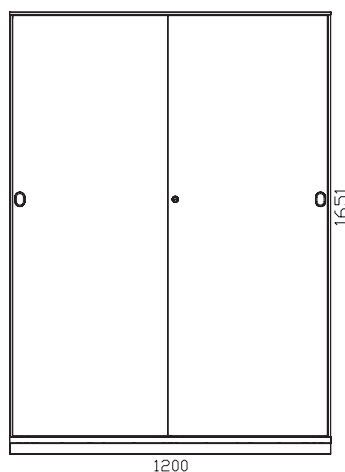
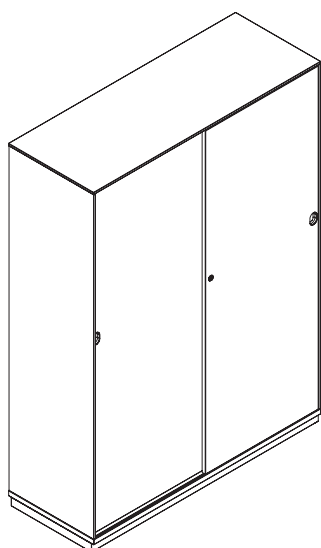

## Primo Sliding Doors

MADE IN ITALY

Armadio anta scorrevole L 1200  
L 1200 x P 450 x H 1651 mm

DESIGNER Takiro Yuta

<b>DESCRIZIONE</b>	Armadio Contenitore ante scorrevoli
<b>DIMENSIONI ESTERNE</b>	L 1200 mm x P 450 mm x H 1651 mm
<b>DIMENSIONI INTERNE VANO</b>	L 1146 mm x P 388 mm x H 1560 mm
<b>DOX</b>	Capienza Dox N° 13 (x4)
<b>CARTELLINE</b>	Capienza 105 (x3) cartelline
<b>PRODUZIONE</b>	<ul style="list-style-type: none"> <li>&gt; Dieffebi S.p.a.</li> <li>&gt; Inizio produzione: anno 2018</li> <li>&gt; Luogo di produzione: Italia</li> </ul>
<b>MANUTENZIONE</b>	<ul style="list-style-type: none"> <li>&gt; Pulire con panno morbido</li> <li>&gt; Non trattare le superfici con panni abrasivi</li> </ul>
<b>MATERIALI</b>	> struttura e ante: in metallo riciclato e riciclabile
<b>FINITURA</b>	<ul style="list-style-type: none"> <li>&gt; Verniciatura a polveri basso emissive (materiale inerte)</li> <li>&gt; Esenti da metalli pesanti</li> <li>&gt; Assenza di spigoli vivi e bordi taglienti</li> <li>&gt; Finitura anti riflesso</li> <li>&gt; Non contiene VOC</li> </ul>
<b>COMPONENTI STANDARD</b>	<ul style="list-style-type: none"> <li>&gt; Serratura a cilindro con 2 chiavi (fissa +pieghevole).</li> <li>&gt; Cilindro estraibile</li> <li>&gt; Maniglia incassata</li> <li>&gt; Ripiani regolabili: in metallo predisposti per cartelle sospese.</li> <li>&gt; Portata ripiani: 50 Kg</li> <li>&gt; Piedini regolabili H 40mm</li> <li>&gt; Viti per assemblaggio</li> </ul>

<b>COLORI</b>	<ul style="list-style-type: none"> <li>&gt; Disponibile in 3 colori standard</li> <li>V1 Bianco (RAL 9010)</li> <li>V6 Alluminio (RAL 9006)</li> <li>V22 Nero (RAL9005)</li> <li>&gt; Colori standard semilucidi</li> <li>&gt; Colori personalizzabili su richiesta previa disponibilità e con sovrapprezzo: <a href="http://www.dieffebi.com/docs/299/2832/DFB_Colour-Chart-2020.pdf">www.dieffebi.com/docs/299/2832/DFB_Colour-Chart-2020.pdf</a></li> </ul>
<b>ACCESSORI</b>	<ul style="list-style-type: none"> <li>&gt; Top di finitura in vetro laccato bianco RAL 9010</li> <li>&gt; Chiave Master</li> <li>&gt; Chiave per estrazione cilindro</li> <li>&gt; Cilindro per serratura</li> <li>&gt; Ripiano aggiuntivo in metallo</li> <li>&gt; Maniglia in diversi colori</li> <li>&gt; Kit softclosing</li> <li>&gt; Cartelline sospese per ripiano armadio Lungh. 330mm</li> </ul>
<b>PESO NETTO</b>	77,30 Kg
<b>IMBALLO</b>	<ul style="list-style-type: none"> <li>&gt; volume: 0,23 m<sup>3</sup></li> <li>&gt; Film plastico in termoretaibile</li> <li>&gt; Angolari e canale in cartone</li> <li>&gt; Ottimizzato per il trasporto con riduzione di CO2</li> <li>&gt; Fornito smontato</li> <li>&gt; N°colli: 8</li> </ul>
<b>END OF USE</b>	> Corredato di scheda di disassemblaggio per smaltimento.
<b>GARANZIA</b>	> Dieffebi garantisce che il prodotto è stato realizzato usando materiali di alta qualità - <a href="#">Vedi documento di garanzia.</a>

## Primo Sliding Doors

MADE IN ITALY

Armadio anta scorrevole L 1200

L 1200 x P 450 x H 1651 mm

DESIGNER Takiro Yuta

**BENESSERE E AMBIENTE** > Design "green" in accordo con gli standard LEED®, per progettare ed arredare ambienti ad alto contenuto di sostenibilità.



www.GreenTop.com



**TEST STRUTTURA** EN 14073-2:2004, par. 3.4  
 EN 14073-3:2004, par. 5.2  
 EN 14073-3:2004, par. 5.3.1  
 EN 14073-3:2004, par. 5.3.2  
 EN 14074:2004, par. 6.4.1  
 EN 14074:2004, par. 6.4.2  
 UNI8606:1984  
 EN16122:2012 + AC:2015, par. 6.1.4"

**TEST FINITURA** UNI EN ISO 2409:2013  
 NSS UNI EN ISO 9227:2017  
 UNI EN 15187:2007 EN ISO 1520:2006  
 UNI EN ISO 6272-1:2013  
 UNI EN 15185:2011  
 UNI EN 15186:2012, met.B  
 UNI 9300:2015  
 EN 12720:2013  
 EN 12721:2013  
 UNI 9429:2015

**CLASSE DI REAZIONE AL FUOCO** > Classe 0

**POSIZIONAMENTO** > Sia a muro che in centro stanza



dieffebi



MADE IN EUROPE



ASSUFFICIO  
 ASSOCIAZIONE FIDELIENEGARRECO

ADIMEMBER



consip  
 acqustinretepa.it  
 Il Fornitore degli Appalti Pubblici per l'edilizia

Dieffebi SpA

via Palù 36  
 San Vendemiano,  
 31020 Treviso - Italia

T +39 0438 4715  
 F +39 0438 471600  
 exportsales@dieffebi.com  
 vendite@dieffebi.com  
 www.dieffebi.com

## Primo Sliding Doors

Vernici  
Varnish  
Vernis  
Lacke

Corpo  
Cabinet Body  
Caisson  
Korpus



**-V1**  
S711 (RAL 9010)  
Pure white



**-V6**  
S380 (RAL 9006)  
White aluminium



**-V22**  
S811 (RAL 9005)  
Jet black

Ripiano aggiuntivo  
in metallo  
Additional metal shelf  
Tablette supplémentaire  
en métal  
Zusätzlicher  
Metallfachboden



**-V1**  
S711 (RAL 9010)  
Pure white



**-V6**  
S380 (RAL 9006)  
White aluminium



**-V22**  
S811 (RAL 9005)  
Jet black

Maniglia colorata  
Coloured handle  
Poignée couleur  
Farbiger Griff



**-V8**  
6013 (RAL 6013)  
Green



**-V15**  
1021 (RAL 1021)  
Yellow



**-V17**  
5024 (RAL 5024)  
Pastel Blue



**-V19**  
S210 (RAL 7021)  
Black grey



**-V24**  
3005 (RAL 3005)  
Wine red

Vetro  
Glass  
Verre  
Glas

Top di finitura in vetro  
laccato bianco  
White lacquered glass top  
Plateau en verre laqué  
blanc  
Glasabdeckplatte weiß  
lackiert

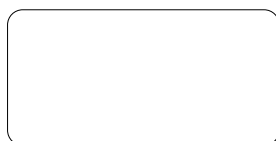

**-G1**  
Bianco/White/Blanc/Weiß

## Primo Sliding Doors

MADE IN ITALY

Armadio anta scorrevole L 1600  
L 1600 x P 450 x H 1651 mm

Struttura: metallo

V1 ○ bianco RAL 9010

art.6PSCK206Z S711

V6 ● alluminio RAL 9006

art.6PSCK206Z S380

V22 ● nero RAL 9005

art.6PSCK206Z S811

DESIGNER Takiro Yuta

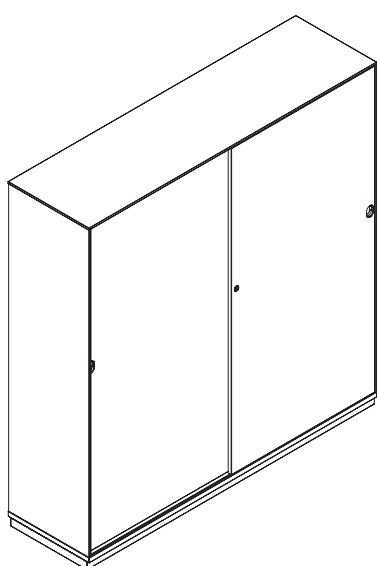

Fronte

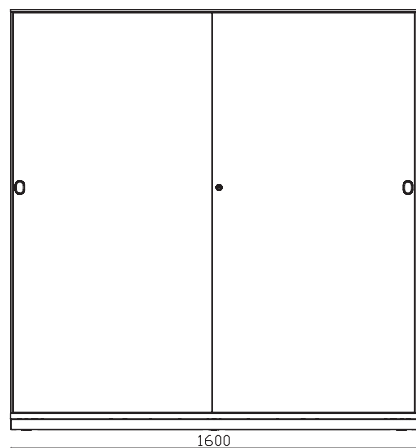

Fianco

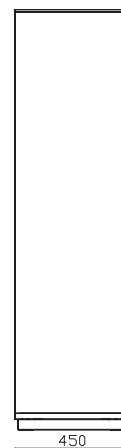

Retro

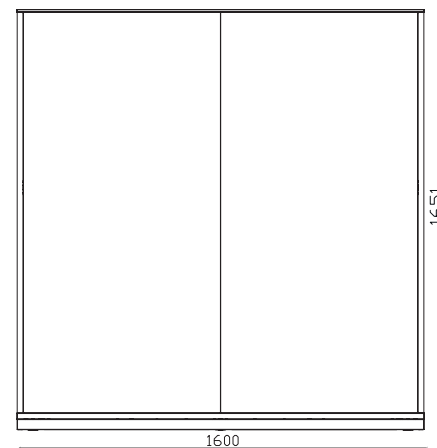

## Primo Sliding Doors

MADE IN ITALY

Armadio anta scorrevole L 1600  
L 1600 x P 450 x H 1651 mm

DESIGNER Takiro Yuta

<b>DESCRIZIONE</b>	Armadio Contenitore ante scorrevoli
<b>DIMENSIONI ESTERNE</b>	L 1600 mm x P 450 mm x H 1651 mm
<b>DIMENSIONI INTERNE VANO</b>	2 x (L 763 mm x P 388 mm x h 1560)
<b>DOX</b>	Capienza Dox N° 8 (x6)
<b>CARTELLINE</b>	Capienza 65 (x6) cartelline
<b>PRODUZIONE</b>	<ul style="list-style-type: none"> <li>&gt; Dieffebi S.p.a.</li> <li>&gt; Inizio produzione: anno 2018</li> <li>&gt; Luogo di produzione: Italia</li> </ul>
<b>MANUTENZIONE</b>	<ul style="list-style-type: none"> <li>&gt; Pulire con panno morbido</li> <li>&gt; Non trattare le superfici con panni abrasivi</li> </ul>
<b>MATERIALI</b>	> struttura e ante: in metallo riciclato e riciclabile
<b>FINITURA</b>	<ul style="list-style-type: none"> <li>&gt; Verniciatura a polveri basso emissive (materiale inerte)</li> <li>&gt; Esenti da metalli pesanti</li> <li>&gt; Assenza di spigoli vivi e bordi taglienti</li> <li>&gt; Finitura anti riflesso</li> <li>&gt; Non contiene VOC</li> </ul>
<b>COMPONENTI STANDARD</b>	<ul style="list-style-type: none"> <li>&gt; Serratura a cilindro con 2 chiavi (fissa +pieghevole).</li> <li>&gt; Cilindro estraibile</li> <li>&gt; Maniglia incassata</li> <li>&gt; Ripiani regolabili: in metallo predisposti per cartelle sospese.</li> <li>&gt; Portata ripiani: 50 Kg</li> <li>&gt; Piedini regolabili H 40mm</li> <li>&gt; Viti per assemblaggio</li> </ul>

<b>COLORI</b>	<ul style="list-style-type: none"> <li>&gt; Disponibile in 3 colori standard</li> <li>V1 Bianco (RAL 9010)</li> <li>V6 Alluminio (RAL 9006)</li> <li>V22 Nero (RAL9005)</li> <li>&gt; Colori standard semilucidi</li> <li>&gt; Colori personalizzabili su richiesta previa disponibilità e con sovrapprezzo: <a href="http://www.dieffebi.com/docs/299/2832/DFB_Colour-Chart-2020.pdf">www.dieffebi.com/docs/299/2832/DFB_Colour-Chart-2020.pdf</a></li> </ul>
<b>ACCESSORI</b>	<ul style="list-style-type: none"> <li>&gt; Top di finitura in vetro laccato bianco RAL 9010</li> <li>&gt; Chiave Master</li> <li>&gt; Chiave per estrazione cilindro</li> <li>&gt; Cilindro per serratura</li> <li>&gt; Ripiano aggiuntivo in metallo</li> <li>&gt; Maniglia in diversi colori</li> <li>&gt; Kit softclosing</li> <li>&gt; Cartelline sospese per ripiano armadio Lungh. 330mm</li> </ul>
<b>PESO NETTO</b>	107,70 Kg
<b>IMBALLO</b>	<ul style="list-style-type: none"> <li>&gt; volume: 0,38 m<sup>3</sup></li> <li>&gt; Film plastico in termoretaibile</li> <li>&gt; Angolari e canale in cartone</li> <li>&gt; Ottimizzato per il trasporto con riduzione di CO2</li> <li>&gt; Fornito smontato</li> <li>&gt; N°colli: 9</li> </ul>
<b>END OF USE</b>	> Corredato di scheda di disassemblaggio per smaltimento.
<b>GARANZIA</b>	> Dieffebi garantisce che il prodotto è stato realizzato usando materiali di alta qualità - <a href="#">Vedi documento di garanzia.</a>

## Primo Sliding Doors

MADE IN ITALY

Armadio anta scorrevole L 1600

L 1600 x P 450 x H 1651 mm

DESIGNER Takiro Yuta

**BENESSERE E AMBIENTE** > Design "green" in accordo con gli standard LEED®, per progettare ed arredare ambienti ad alto contenuto di sostenibilità.



www.GreenTop.com



**TEST STRUTTURA** EN 14073-2:2004, par. 3.4  
 EN 14073-3:2004, par. 5.2  
 EN 14073-3:2004, par. 5.3.1  
 EN 14073-3:2004, par. 5.3.2  
 EN 14074:2004, par. 6.4.1  
 EN 14074:2004, par. 6.4.2  
 UNI8606:1984  
 EN16122:2012 + AC:2015, par. 6.1.4"

**TEST FINITURA** UNI EN ISO 2409:2013  
 NSS UNI EN ISO 9227:2017  
 UNI EN 15187:2007 EN ISO 1520:2006  
 UNI EN ISO 6272-1:2013  
 UNI EN 15185:2011  
 UNI EN 15186:2012, met.B  
 UNI 9300:2015  
 EN 12720:2013  
 EN 12721:2013  
 UNI 9429:2015

**CLASSE DI REAZIONE AL FUOCO** > Classe 0

**POSIZIONAMENTO** > Sia a muro che in centro stanza



dieffebi



MADE IN EUROPE



ASSUFFICIO  
 ASSOCIAZIONE FIDELIENEGARRECO

ADIMEMBER



consip  
 acqustinretepa.it  
 Il Fornitore degli Appalti Pubblici per l'edilizia

Dieffebi SpA

via Palù 36  
 San Vendemiano,  
 31020 Treviso - Italia

T +39 0438 4715  
 F +39 0438 471600  
 exportsales@dieffebi.com  
 vendite@dieffebi.com  
 www.dieffebi.com

## Primo Sliding Doors

### Vernici Varnish Vernis Lacke

Corpo  
Cabinet Body  
Caisson  
Korpus



**-V1**  
S711 (RAL 9010)  
Pure white



**-V6**  
S380 (RAL 9006)  
White aluminium

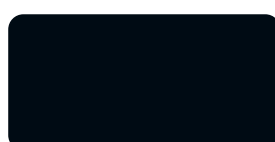

**-V22**  
S811 (RAL 9005)  
Jet black

Ripiano aggiuntivo  
in metallo  
Additional metal shelf  
Tablette supplémentaire  
en métal  
Zusätzlicher  
Metallfachboden



**-V1**  
S711 (RAL 9010)  
Pure white



**-V6**  
S380 (RAL 9006)  
White aluminium

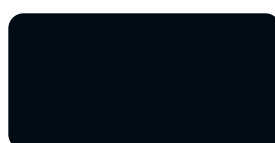

**-V22**  
S811 (RAL 9005)  
Jet black

Maniglia colorata  
Coloured handle  
Poignée couleur  
Farbiger Griff



**-V8**  
6013 (RAL 6013)  
Green



**-V15**  
1021 (RAL 1021)  
Yellow



**-V17**  
5024 (RAL 5024)  
Pastel Blue



**-V19**  
S210 (RAL 7021)  
Black grey



**-V24**  
3005 (RAL 3005)  
Wine red

### Vetro Glass Verre Glas

Top di finitura in vetro  
laccato bianco  
White lacquered glass top  
Plateau en verre laqué  
blanc  
Glasabdeckplatte weiß  
lackiert

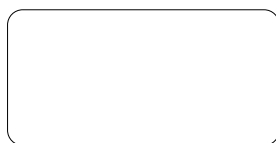

**-G1**  
Bianco/White/Blanc/Weiß



## Primo Sliding Doors

MADE IN ITALY

Armadio anta scorrevole L 1200  
L 1200 x P 450 x H 2003 mm

Struttura: metallo

V1 ○ bianco RAL 9010

art.6PSCK107Z S711

V6 ● alluminio RAL 9006

art.6PSCK107Z S380

V22 ● nero RAL 9005

art.6PSCK107Z S811

DESIGNER Takiro Yuta

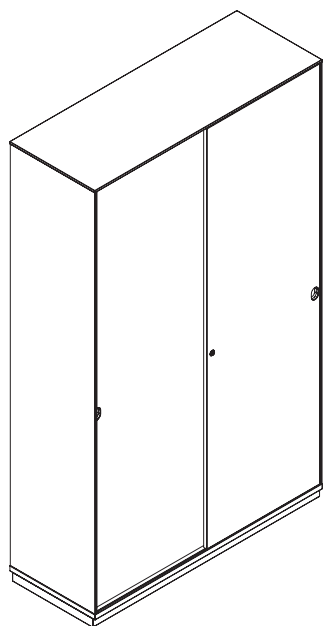

Fronte

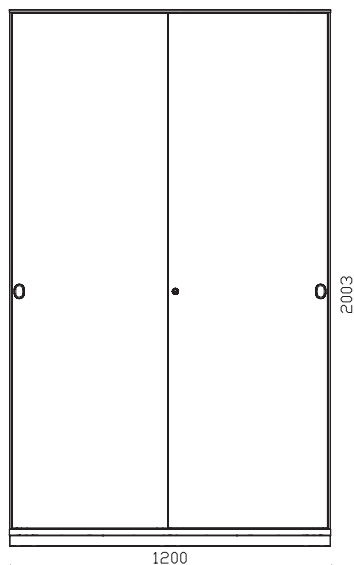

Fianco

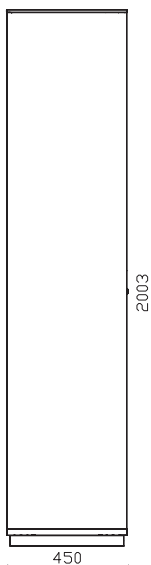

Retro

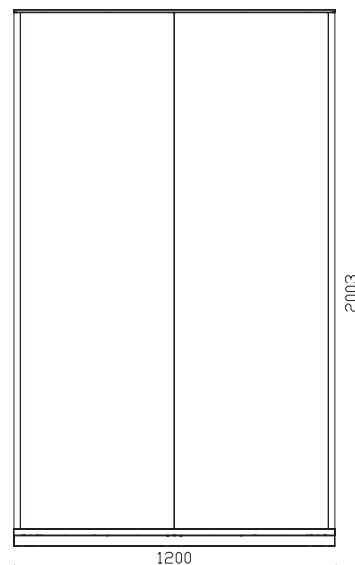

## Primo Sliding Doors

MADE IN ITALY

Armadio anta scorrevole L 1200  
L 1200 x P 450 x H 2003 mm

DESIGNER Takiro Yuta

<b>DESCRIZIONE</b>	Armadio Contenitore ante scorrevoli
<b>DIMENSIONI ESTERNE</b>	L 1200 mm x P 450 mm x H 2003 mm
<b>DIMENSIONI INTERNE VANO</b>	L 1146 mm x P 388 mm x H 1913 mm
<b>DOX</b>	Capienza Dox N° 13 (x5)
<b>CARTELLINE</b>	Capienza 105 (x4) cartelline
<b>PRODUZIONE</b>	<ul style="list-style-type: none"> <li>&gt; Dieffebi S.p.a.</li> <li>&gt; Inizio produzione: anno 2018</li> <li>&gt; Luogo di produzione: Italia</li> </ul>
<b>MANUTENZIONE</b>	<ul style="list-style-type: none"> <li>&gt; Pulire con panno morbido</li> <li>&gt; Non trattare le superfici con panni abrasivi</li> </ul>
<b>MATERIALI</b>	> struttura e ante: in metallo riciclato e riciclabile
<b>FINITURA</b>	<ul style="list-style-type: none"> <li>&gt; Verniciatura a polveri basso emissive (materiale inerte)</li> <li>&gt; Esenti da metalli pesanti</li> <li>&gt; Assenza di spigoli vivi e bordi taglienti</li> <li>&gt; Finitura anti riflesso</li> <li>&gt; Non contiene VOC</li> </ul>
<b>COMPONENTI STANDARD</b>	<ul style="list-style-type: none"> <li>&gt; Serratura a cilindro con 2 chiavi (fissa +pieghevole).</li> <li>&gt; Cilindro estraibile</li> <li>&gt; Maniglia incassata</li> <li>&gt; Ripiani regolabili: in metallo predisposti per cartelle sospese.</li> <li>&gt; Portata ripiani: 50 Kg</li> <li>&gt; Piedini regolabili H 40mm</li> <li>&gt; Viti per assemblaggio</li> </ul>

<b>COLORI</b>	<ul style="list-style-type: none"> <li>&gt; Disponibile in 3 colori standard</li> <li>V1 Bianco (RAL 9010)</li> <li>V6 Alluminio (RAL 9006)</li> <li>V22 Nero (RAL9005)</li> <li>&gt; Colori standard semilucidi</li> <li>&gt; Colori personalizzabili su richiesta previa disponibilità e con sovrapprezzo: <a href="http://www.dieffebi.com/docs/299/2832/DFB_Colour-Chart-2020.pdf">www.dieffebi.com/docs/299/2832/DFB_Colour-Chart-2020.pdf</a></li> </ul>
<b>ACCESSORI</b>	<ul style="list-style-type: none"> <li>&gt; Top di finitura in vetro laccato bianco RAL 9010</li> <li>&gt; Chiave Master</li> <li>&gt; Chiave per estrazione cilindro</li> <li>&gt; Cilindro per serratura</li> <li>&gt; Ripiano aggiuntivo in metallo</li> <li>&gt; Maniglia in diversi colori</li> <li>&gt; Kit softclosing</li> <li>&gt; Cartelline sospese per ripiano armadio Lungh. 330mm</li> </ul>
<b>PESO NETTO</b>	89,00 Kg
<b>IMBALLO</b>	<ul style="list-style-type: none"> <li>&gt; volume: 0,31 m<sup>3</sup></li> <li>&gt; Film plastico in termoretaibile</li> <li>&gt; Angolari e canale in cartone</li> <li>&gt; Ottimizzato per il trasporto con riduzione di CO2</li> <li>&gt; Fornito smontato</li> <li>&gt; N°colli: 8</li> </ul>
<b>END OF USE</b>	> Corredato di scheda di disassemblaggio per smaltimento.
<b>GARANZIA</b>	> Dieffebi garantisce che il prodotto è stato realizzato usando materiali di alta qualità - <a href="#">Vedi documento di garanzia.</a>

## Primo Sliding Doors

MADE IN ITALY

Armadio anta scorrevole L 1200

L 1200 x P 450 x H 2003 mm

DESIGNER Takiro Yuta

**BENESSERE E AMBIENTE** > Design "green" in accordo con gli standard LEED®, per progettare ed arredare ambienti ad alto contenuto di sostenibilità.



www.GreenTop.com



**TEST STRUTTURA** EN 14073-2:2004, par. 3.4  
 EN 14073-3:2004, par. 5.2  
 EN 14073-3:2004, par. 5.3.1  
 EN 14073-3:2004, par. 5.3.2  
 EN 14074:2004, par. 6.4.1  
 EN 14074:2004, par. 6.4.2  
 UNI8606:1984  
 EN16122:2012 + AC:2015, par. 6.1.4"

**TEST FINITURA** UNI EN ISO 2409:2013  
 NSS UNI EN ISO 9227:2017  
 UNI EN 15187:2007 EN ISO 1520:2006  
 UNI EN ISO 6272-1:2013  
 UNI EN 15185:2011  
 UNI EN 15186:2012, met.B  
 UNI 9300:2015  
 EN 12720:2013  
 EN 12721:2013  
 UNI 9429:2015

**CLASSE DI REAZIONE AL FUOCO** > Classe 0

**POSIZIONAMENTO** > Sia a muro che in centro stanza



dieffebi



MADE IN EUROPE



ASSUFFICIO  
 ASSOCIAZIONE FIDELIENEGARRECO

ADIMEMBER



consip  
 acqustinretepa.it  
Il Fornitore degli Appalti Pubblici per l'edilizia

Dieffebi SpA

via Palù 36  
 San Vendemiano,  
 31020 Treviso - Italia

T +39 0438 4715  
 F +39 0438 471600  
 exportsales@dieffebi.com  
 vendite@dieffebi.com  
 www.dieffebi.com

## Primo Sliding Doors

### Vernici Varnish Vernis Lacke

Corpo  
Cabinet Body  
Caisson  
Korpus



**-V1**  
S711 (RAL 9010)  
Pure white



**-V6**  
S380 (RAL 9006)  
White aluminium



**-V22**  
S811 (RAL 9005)  
Jet black

Ripiano aggiuntivo  
in metallo  
Additional metal shelf  
Tablette supplémentaire  
en métal  
Zusätzlicher  
Metallfachboden



**-V1**  
S711 (RAL 9010)  
Pure white



**-V6**  
S380 (RAL 9006)  
White aluminium



**-V22**  
S811 (RAL 9005)  
Jet black

Maniglia colorata  
Coloured handle  
Poignée couleur  
Farbiger Griff



**-V8**  
6013 (RAL 6013)  
Green



**-V15**  
1021 (RAL 1021)  
Yellow



**-V17**  
5024 (RAL 5024)  
Pastel Blue



**-V19**  
S210 (RAL 7021)  
Black grey



**-V24**  
3005 (RAL 3005)  
Wine red

### Vetro Glass Verre Glas

Top di finitura in vetro  
laccato bianco  
White lacquered glass top  
Plateau en verre laqué  
blanc  
Glasabdeckplatte weiß  
lackiert

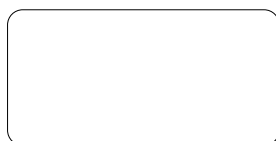

**-G1**  
Bianco/White/Blanc/Weiß