

Primo Sliding Acoustic Doors

MADE IN ITALY

Sliding door cabinet W 1200
W 1200 x D 450 x H 723 mm

Body: metal

V1 ○ white RAL 9010

art.6PSCS101Z S711

V6 ● aluminium RAL 9006

art.6PSCS101Z S380

V22 ● black RAL 9005

art.6PSCS101Z S811

DESIGNER Takiro Yuta

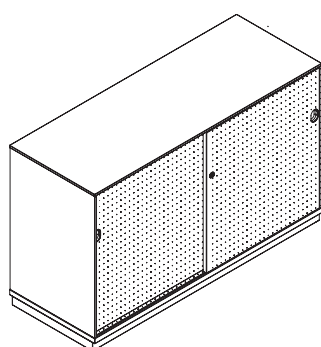

Front

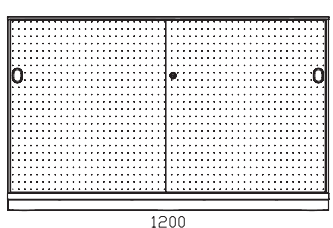

Side

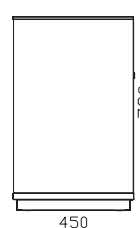

Back

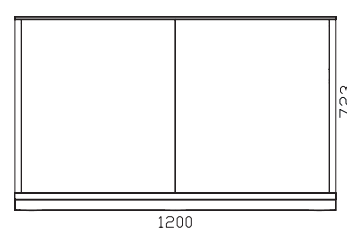

Primo Sliding Acoustic Doors

MADE IN ITALY

Sliding door cabinet W 1200
W 1200 x D 450 x H 723 mm

DESIGNER Takiro Yuta

DESCRIPTION	Sliding door cabinet
EXTERNAL DIMENSIONS	W 1200 mm x D 450 mm x H 723 mm
INTERNAL DIMENSIONS	W 1146 x D 388 mm x H 633 mm
BINDERS	Capacity: N°13
HANGING FILES	Capacity: 105 hanging files
PRODUCTION	<ul style="list-style-type: none"> > Dieffebi S.p.a. > Start of production: 2018 > Country of production: Italy
MAINTENANCE	<ul style="list-style-type: none"> > Clean with a soft cloth > Do not treat the surfaces with abrasive cloths
STRUCTURE MATERIALS	<ul style="list-style-type: none"> > Recycled and recyclable metal
DOORS MATERIALS	<ul style="list-style-type: none"> > In recycled and recyclable 2 mm diameter micro-perforated metal > Sound-absorbing cellulose and glass fiber fabric
FINISHING	<ul style="list-style-type: none"> > Low-emission powder coating (material inert) > Heavy metals free > Absence of sharp edges > Anti-glare finish > It does not contain VOC
STANDARD COMPONENTS	<ul style="list-style-type: none"> > Cylinder lock with 2 keys (fixed + foldable) > Removable cylinder > Recessed handle > Adjustable shelves: in metal designed for suspended files > Shelf capacity: 50 Kg > Plinth with adjustable feet H 40 mm > Assembly screws

COLORS	<ul style="list-style-type: none"> > Available in 3 standard colors V1 white (RAL 9010) V6 aluminium (RAL 9006) V22 black (RAL9005) > standard semi-gloss colors > Customizable colors available upon request and with an extra charge: www.dieffebi.com/docs/299/2832/DFB_Colour-Chart-2020.pdf
---------------	--------------------------------------------------------------------------------------------------------------------------------------------------------------------------------------------------------------------------------------------------------------------------------------------------------------------------------------------------------------------------------------------------------------------------------------------------------------

ACCESSORIES	<ul style="list-style-type: none"> > White lacquered glass top RAL 9010 > Master key > Cylinder extraction key > Cylinder for keylock > Additional metal shelf > Handle in various colors > Kit softclosing > Hanging files for under cabinet shelves, length: 330 mm
--------------------	-----------------------------------------------------------------------------------------------------------------------------------------------------------------------------------------------------------------------------------------------------------------------------------------------------------------------------------------------------------------------------

NET WEIGHT 46,90 Kg

PACKAGING	<ul style="list-style-type: none"> > volume: 0,15 m³ > Plastic film in heat shrink > Cardboard corners and channel > Optimized for transport with CO2 reduction > Delivered: disassembled > Packages: 7
------------------	--------------------------------------------------------------------------------------------------------------------------------------------------------------------------------------------------------------------------------------------------------------------------------------------------

END OF USE > Equipped with disassembly card for disposal

WARRANTY > Dieffebi guarantees that the product was made using high quality materials - [See warranty document](#)

Primo Sliding Acoustic Doors

MADE IN ITALY

Sliding door cabinet W 1200
W 1200 x D 450 x H 723 mm

DESIGNER Takiro Yuta

WELLNESS AND ENVIRONMENT > Green design in accordance with LEED® standards, to design and furnish environments with a high sustainability content



www.GreenTop.com



STRUCTURE TEST EN 14073-2:2004, par. 3.4
EN 14073-3:2004, par. 5.2
EN 14073-3:2004, par. 5.3.1
EN 14073-3:2004, par. 5.3.2
EN 14074:2004, par. 6.4.1
EN 14074:2004, par. 6.4.2
UNI8606:1984
EN 16122:2012 + AC:2015, par. 6.1.4

ACOUSTIC PERFORMANCE TEST UNI EN ISO 354/03
UNI EN ISO 11654/98
Alfaw 0,55 CLASSE D
ASMT C423 - 09A NCR 0,55
Test Zetalab - Cerea (VR)

FINISHING TEST UNI EN ISO 2409:2013
NSS UNI EN ISO 9227:2017
UNI EN 15187:2007 EN ISO 1520:2006
UNI EN ISO 6272-1:2013
UNI EN 15185:2011
UNI EN 15186:2012, met.B
UNI 9300:2015
EN 12720:2013
EN 12721:2013
UNI 9429:2015

CLASS OF REACTION TO FIRE > Class 0

POSITIONING > Both on the wall and in the center of the room



dieffebi



MADE IN EUROPE



ASSUFFICIO
ASSOCIAZIONE FIDELIENEGARRECO

ADIMEMBER



consip
acquistinretepa.it

Dieffebi SpA

via Palù 36
San Vendemiano,
31020 Treviso - Italia

T +39 0438 4715
F +39 0438 471600
exportsales@dieffebi.com
vendite@dieffebi.com
www.dieffebi.com

Primo Sliding Acoustic Doors

Varnish Vernici Vernis Lacke

Cabinet Body
Corpo
Caisson
Korpus



-V1
S711 (RAL 9010)
Pure white



-V6
S380 (RAL 9006)
White aluminium

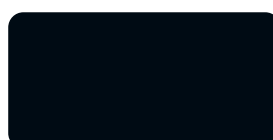

-V22
S811 (RAL 9005)
Jet black

Additional metal shelf
Ripiano aggiuntivo
in metallo
Tablette supplémentaire
en métal
Zusätzlicher
Metallfachboden

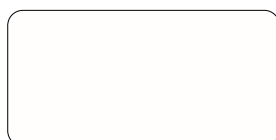

-V1
S711 (RAL 9010)
Pure white



-V6
S380 (RAL 9006)
White aluminium

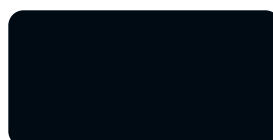

-V22
S811 (RAL 9005)
Jet black

Coloured handle
Maniglia colorata
Poignée couleur
Farbiger Griff



-V8
6013 (RAL 6013)
Green



-V15
1021 (RAL 1021)
Yellow



-V17
5024 (RAL 5024)
Pastel Blue



-V19
S210 (RAL 7021)
Black grey



-V24
3005 (RAL 3005)
Wine red

Glass Vetro Verre Glas

White lacquered glass top
Top di finitura in vetro
laccato bianco
Plateau en verre laqué
blanc
Glasabdeckplatte weiß
lackiert



-G1
Bianco/White/Blanc/Weiß

Primo Sliding Acoustic Doors

MADE IN ITALY

Sliding door cabinet W 1600
W 1600 x D 450 x H 1171 mm

Body: metal

V1 ○ white RAL 9010

art.6PSCS204Z S711

V6 ● aluminium RAL 9006

art.6PSCS204Z S380

V22 ● black RAL 9005

art.6PSCS204Z S811

DESIGNER Takiro Yuta

Front

Side

Back

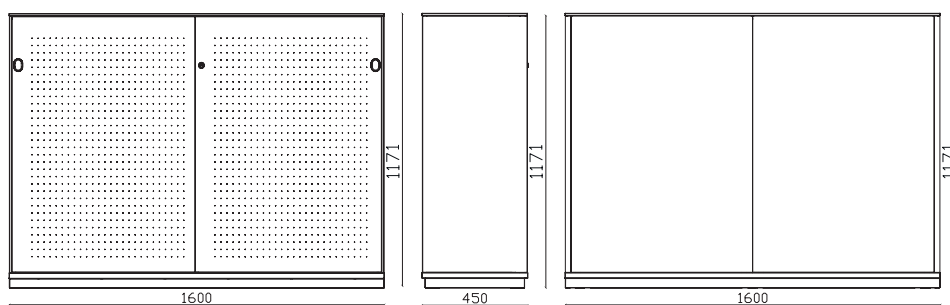
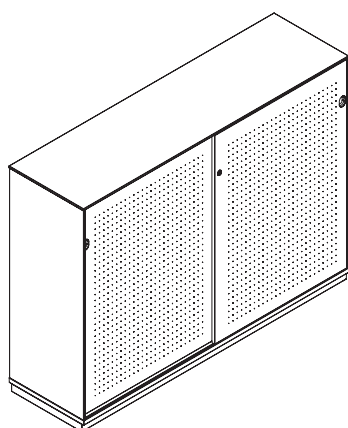

Primo Sliding Acoustic Doors

MADE IN ITALY

Sliding door cabinet W 1600
W 1600 x D 450 x H 1171 mm

DESIGNER Takiro Yuta

DESCRIPTION	Sliding door cabinet
EXTERNAL DIMENSIONS	W 1600 mm x D 450 mm x H 1171 mm
INTERNAL DIMENSIONS	2 x (W 763 mm x D 388 mm x H 1081 mm)
BINDERS	N° 8 (x4)
HANGING FILES	65 (x4) hanging files
PRODUCTION	<ul style="list-style-type: none"> > Dieffebi S.p.a. > Start of production: 2018 > Country of production: Italy
MAINTENANCE	<ul style="list-style-type: none"> > Clean with a soft cloth > Do not treat the surfaces with abrasive cloths
STRUCTURE MATERIALS	> Recycled and recyclable metal
DOORS MATERIALS	<ul style="list-style-type: none"> > In recycled and recyclable 2 mm diameter micro-perforated metal > Sound-absorbing cellulose and glass fiber fabric
FINISHING	<ul style="list-style-type: none"> > Low-emission powder coating (material inert) > Heavy metals free > Absence of sharp edges > Anti-glare finish > It does not contain VOC
STANDARD COMPONENTS	<ul style="list-style-type: none"> > Cylinder lock with 2 keys (fixed + foldable) > Removable cylinder > Recessed handle > Adjustable shelves: in metal designed for suspended files > Shelf capacity: 50 Kg > Plinth with adjustable feet H 40 mm > Assembly screws

COLORS	<ul style="list-style-type: none"> > Available in 3 standard colors V1 white (RAL 9010) V6 aluminium (RAL 9006) V22 black (RAL9005) > standard semi-gloss colors > Customizable colors available upon request and with an extra charge: www.dieffebi.com/docs/299/2832/DFB_Colour-Chart-2020.pdf
---------------	--------------------------------------------------------------------------------------------------------------------------------------------------------------------------------------------------------------------------------------------------------------------------------------------------------------------------------------------------------------------------------------------------------------------------------------------------------------

ACCESSORIES	<ul style="list-style-type: none"> > White lacquered glass top RAL 9010 > Master key > Cylinder extraction key > Cylinder for keylock > Additional metal shelf > Handle in various colors > Kit softclosing > Hanging files for under cabinet shelves, length: 330 mm
--------------------	-----------------------------------------------------------------------------------------------------------------------------------------------------------------------------------------------------------------------------------------------------------------------------------------------------------------------------------------------------------------------------

NET WEIGHT	91,00 Kg
-------------------	----------

PACKAGING	<ul style="list-style-type: none"> > volume: 0,27 m³ > Plastic film in heat shrink > Cardboard corners and channel > Optimized for transport with CO2 reduction > Delivered: disassembled > Packages: 8
------------------	--------------------------------------------------------------------------------------------------------------------------------------------------------------------------------------------------------------------------------------------------------------------------------------------------

END OF USE	> Equipped with disassembly card for disposal
-------------------	-----------------------------------------------

WARRANTY	> Dieffebi guarantees that the product was made using high quality materials - See warranty document
-----------------	----------------------------------------------------------------------------------------------------------------------

Primo Sliding Acoustic Doors

MADE IN ITALY

Sliding door cabinet W 1600
W 1600 x D 450 x H 1171 mm

DESIGNER Takiro Yuta

WELLNESS AND ENVIRONMENT > Green design in accordance with LEED® standards, to design and furnish environments with a high sustainability content



STRUCTURE TEST EN 14073-2:2004, par. 3.4
EN 14073-3:2004, par. 5.2
EN 14073-3:2004, par. 5.3.1
EN 14073-3:2004, par. 5.3.2
EN 14074:2004, par. 6.4.1
EN 14074:2004, par. 6.4.2
UNI8606:1984
EN 16122:2012 + AC:2015, par. 6.1.4

ACOUSTIC PERFORMANCE TEST UNI EN ISO 354/03
UNI EN ISO 11654/98
Alfaw 0,55 CLASSE D
ASMT C423 - 09A NCR 0,55
Test Zetalab - Cerea (VR)

FINISHING TEST UNI EN ISO 2409:2013
NSS UNI EN ISO 9227:2017
UNI EN 15187:2007 EN ISO 1520:2006
UNI EN ISO 6272-1:2013
UNI EN 15185:2011
UNI EN 15186:2012, met.B
UNI 9300:2015
EN 12720:2013
EN 12721:2013
UNI 9429:2015

CLASS OF REACTION TO FIRE > Class 0

POSITIONING > Both on the wall and in the center of the room



ADIMEMBER



Dieffebi SpA

T +39 0438 4715
F +39 0438 471600
exportsales@dieffebi.com
vendite@dieffebi.com
www.dieffebi.com

Primo Sliding Acoustic Doors

Varnish Vernici Vernis Lacke

Cabinet Body
Corpo
Caisson
Korpus



-V1
S711 (RAL 9010)
Pure white



-V6
S380 (RAL 9006)
White aluminium

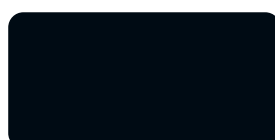

-V22
S811 (RAL 9005)
Jet black

Additional metal shelf
Ripiano aggiuntivo
in metallo
Tablette supplémentaire
en métal
Zusätzlicher
Metallfachboden



-V1
S711 (RAL 9010)
Pure white



-V6
S380 (RAL 9006)
White aluminium

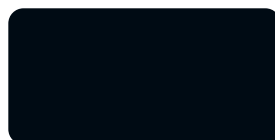

-V22
S811 (RAL 9005)
Jet black

Coloured handle
Maniglia colorata
Poignée couleur
Farbiger Griff



-V8
6013 (RAL 6013)
Green



-V15
1021 (RAL 1021)
Yellow



-V17
5024 (RAL 5024)
Pastel Blue

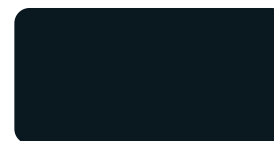

-V19
S210 (RAL 7021)
Black grey



-V24
3005 (RAL 3005)
Wine red

Glass Vetro Verre Glas

White lacquered glass top
Top di finitura in vetro
laccato bianco
Plateau en verre laqué
blanc
Glasabdeckplatte weiß
lackiert

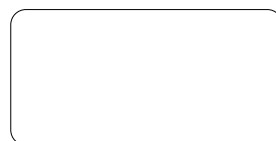

-G1
Bianco/White/Blanc/Weiß

Primo Sliding Acoustic Doors

MADE IN ITALY

Sliding door cabinet W 2000
W 2000 x D 450 x H 1171 mm

Body: metal

V1 ○ white RAL 9010

art.6PSCS304Z S711

V6 ● aluminium RAL 9006

art.6PSCS304Z S380

V22 ● black RAL 9005

art.6PSCS304Z S811

DESIGNER Takiro Yuta

Front

Side

Back

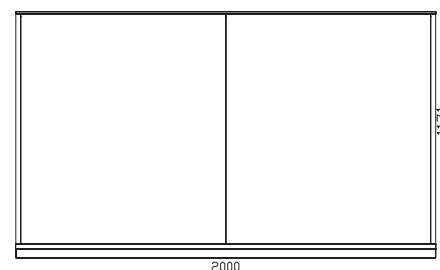
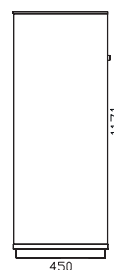
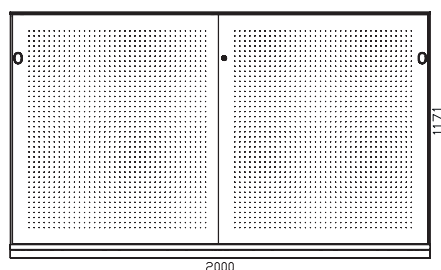
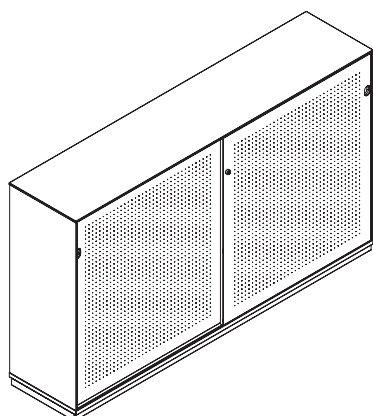

Primo Sliding Acoustic Doors

MADE IN ITALY

Sliding door cabinet W 2000
W 2000 x D 450 x H 1171 mm

DESIGNER Takiro Yuta

DESCRIPTION	Armadio Contenitore ante scorrevoli
EXTERNAL DIMENSIONS	W 2000 mm x D 450 mm x H 1171 mm
INTERNAL DIMENSIONS	2 x (W 963 mm x D 388 mm x H 1081 mm)
BINDERS	N° 10 (x4)
HANGING FILES	80 (x4) hanging files
PRODUCTION	<ul style="list-style-type: none"> > Dieffebi S.p.a. > Start of production: 2018 > Country of production: Italy
MAINTENANCE	<ul style="list-style-type: none"> > Clean with a soft cloth > Do not treat the surfaces with abrasive cloths
STRUCTURE MATERIALS	<ul style="list-style-type: none"> > Recycled and recyclable metal
DOORS MATERIALS	<ul style="list-style-type: none"> > In recycled and recyclable 2 mm diameter micro-perforated metal > Sound-absorbing cellulose and glass fiber fabric
FINISHING	<ul style="list-style-type: none"> > Low-emission powder coating (material inert) > Heavy metals free > Absence of sharp edges > Anti-glare finish > It does not contain VOC
STANDARD COMPONENTS	<ul style="list-style-type: none"> > Cylinder lock with 2 keys (fixed + foldable) > Removable cylinder > Recessed handle > Adjustable shelves: in metal designed for suspended files > Shelf capacity: 50 Kg > Plinth with adjustable feet H 40 mm > Assembly screws

COLORS	<ul style="list-style-type: none"> > Available in 3 standard colors V1 white (RAL 9010) V6 aluminium (RAL 9006) V22 black (RAL9005) > standard semi-gloss colors > Customizable colors available upon request and with an extra charge: www.dieffebi.com/docs/299/2832/DFB_Colour-Chart-2020.pdf
---------------	--------------------------------------------------------------------------------------------------------------------------------------------------------------------------------------------------------------------------------------------------------------------------------------------------------------------------------------------------------------------------------------------------------------------------------------------------------------

ACCESSORIES	<ul style="list-style-type: none"> > White lacquered glass top RAL 9010 > Master key > Cylinder extraction key > Cylinder for keylock > Additional metal shelf > Handle in various colors > Kit softclosing > Hanging files for under cabinet shelves, length: 330 mm
--------------------	-----------------------------------------------------------------------------------------------------------------------------------------------------------------------------------------------------------------------------------------------------------------------------------------------------------------------------------------------------------------------------

NET WEIGHT 99,50 Kg

PACKAGING	<ul style="list-style-type: none"> > volume: 0,33 m³ > Plastic film in heat shrink > Cardboard corners and channel > Optimized for transport with CO2 reduction > Delivered: disassembled > Packages: 8
------------------	--------------------------------------------------------------------------------------------------------------------------------------------------------------------------------------------------------------------------------------------------------------------------------------------------

END OF USE > Equipped with disassembly card for disposal

WARRANTY > Dieffebi guarantees that the product was made using high quality materials - [See warranty document](#)

Primo Sliding Acoustic Doors

MADE IN ITALY

Sliding door cabinet W 2000

W 2000 x D 450 x H 1171 mm

DESIGNER Takiro Yuta

WELLNESS AND ENVIRONMENT > Green design in accordance with LEED® standards, to design and furnish environments with a high sustainability content



STRUCTURE TEST EN 14073-2:2004, par. 3.4
 EN 14073-3:2004, par. 5.2
 EN 14073-3:2004, par. 5.3.1
 EN 14073-3:2004, par. 5.3.2
 EN 14074:2004, par. 6.4.1
 EN 14074:2004, par. 6.4.2
 UNI8606:1984
 EN 16122:2012 + AC:2015, par. 6.1.4

ACOUSTIC PERFORMANCE TEST UNI EN ISO 354/03
 UNI EN ISO 11654/98
 Alfaw 0,55 CLASSE D
 ASMT C423 - 09A NCR 0,55
 Test Zetalab - Cerea (VR)

FINISHING TEST UNI EN ISO 2409:2013
 NSS UNI EN ISO 9227:2017
 UNI EN 15187:2007 EN ISO 1520:2006
 UNI EN ISO 6272-1:2013
 UNI EN 15185:2011
 UNI EN 15186:2012, met.B
 UNI 9300:2015
 EN 12720:2013
 EN 12721:2013
 UNI 9429:2015

CLASS OF REACTION TO FIRE > Class 0

POSITIONING > Both on the wall and in the center of the room



ADIMEMBER



Dieffebi SpA

T +39 0438 4715
 F +39 0438 471600
 exportsales@dieffebi.com
 vendite@dieffebi.com
 www.dieffebi.com

Primo Sliding Acoustic Doors

Varnish Vernici Vernis Lacke

Cabinet Body
Corpo
Caisson
Korpus



-V1
S711 (RAL 9010)
Pure white



-V6
S380 (RAL 9006)
White aluminium

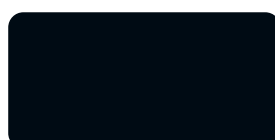

-V22
S811 (RAL 9005)
Jet black

Additional metal shelf
Ripiano aggiuntivo
in metallo
Tablette supplémentaire
en métal
Zusätzlicher
Metallfachboden

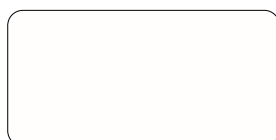

-V1
S711 (RAL 9010)
Pure white



-V6
S380 (RAL 9006)
White aluminium



-V22
S811 (RAL 9005)
Jet black

Coloured handle
Maniglia colorata
Poignée couleur
Farbiger Griff



-V8
6013 (RAL 6013)
Green



-V15
1021 (RAL 1021)
Yellow



-V17
5024 (RAL 5024)
Pastel Blue

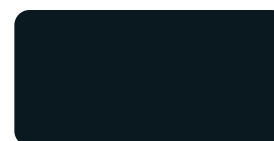

-V19
S210 (RAL 7021)
Black grey



-V24
3005 (RAL 3005)
Wine red

Glass Vetro Verre Glas

White lacquered glass top
Top di finitura in vetro
laccato bianco
Plateau en verre laqué
blanc
Glasabdeckplatte weiß
lackiert

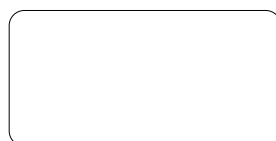

-G1
Bianco/White/Blanc/Weiß

Primo Sliding Acoustic Doors

MADE IN ITALY

Sliding door cabinet W 1200
W 1200 x D 450 x H 2003 mm

Body: metal

V1 ○ white RAL 9010

art.6PSCS107Z S711

V6 ● aluminium RAL 9006

art.6PSCS107Z S380

V22 ● black RAL 9005

art.6PSCS107Z S811

DESIGNER Takiro Yuta

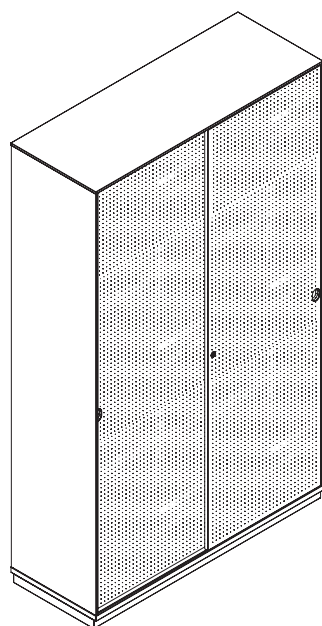

Front

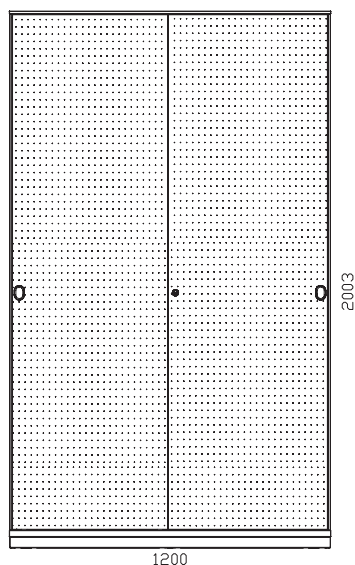

Side

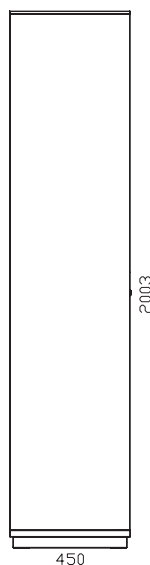

Back

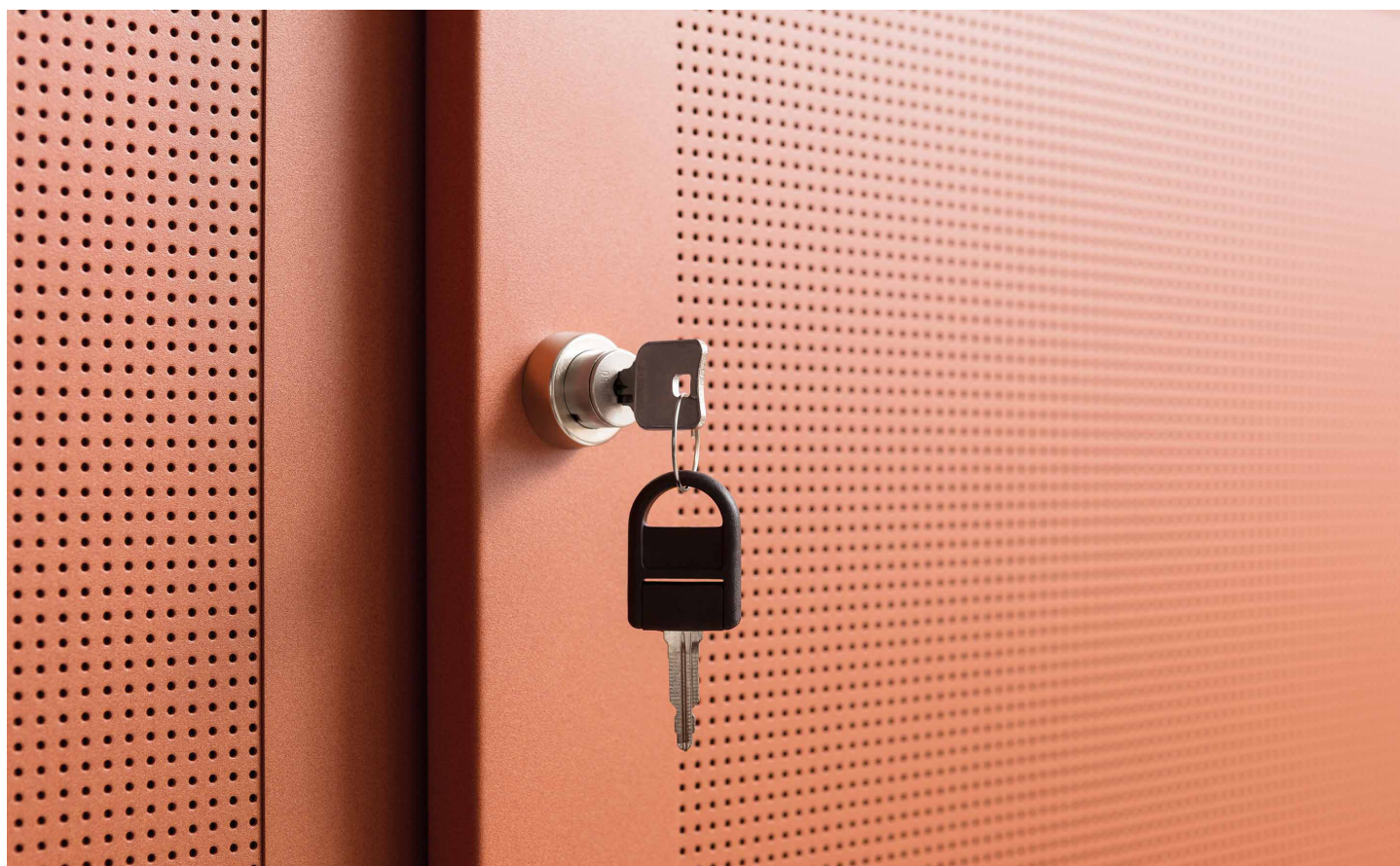
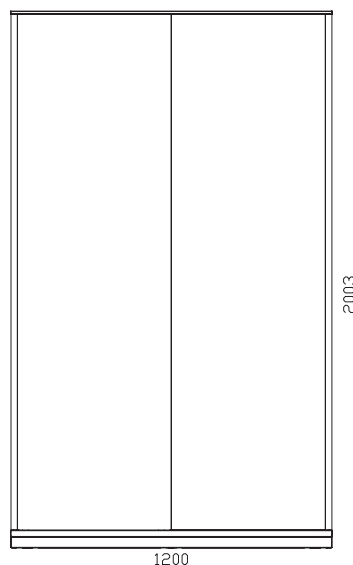

Primo Sliding Acoustic Doors

MADE IN ITALY

Sliding door cabinet W 1200
W 1200 x D 450 x H 2003 mm

DESIGNER Takiro Yuta

DESCRIPTION	Sliding door cabinet
EXTERNAL DIMENSIONS	W 1200 mm x D 450 mm x H 2003 mm
INTERNAL DIMENSIONS	W 1146 mm x D 388 mm x H 1913 mm
BINDERS	N° 13 (x5)
HANGING FILES	105 (x4) hanging files
PRODUCTION	<ul style="list-style-type: none"> > Dieffebi S.p.a. > Start of production: 2018 > Country of production: Italy
MAINTENANCE	<ul style="list-style-type: none"> > Clean with a soft cloth > Do not treat the surfaces with abrasive cloths
STRUCTURE MATERIALS	<ul style="list-style-type: none"> > Recycled and recyclable metal
DOORS MATERIALS	<ul style="list-style-type: none"> > In recycled and recyclable 2 mm diameter micro-perforated metal > Sound-absorbing cellulose and glass fiber fabric
FINISHING	<ul style="list-style-type: none"> > Low-emission powder coating (material inert) > Heavy metals free > Absence of sharp edges > Anti-glare finish > It does not contain VOC
STANDARD COMPONENTS	<ul style="list-style-type: none"> > Cylinder lock with 2 keys (fixed + foldable) > Removable cylinder > Recessed handle > Adjustable shelves: in metal designed for suspended files > Shelf capacity: 50 Kg > Plinth with adjustable feet H 40 mm > Assembly screws

COLORS	<ul style="list-style-type: none"> > Available in 3 standard colors V1 white (RAL 9010) V6 aluminium (RAL 9006) V22 black (RAL9005) > standard semi-gloss colors > Customizable colors available upon request and with an extra charge: www.dieffebi.com/docs/299/2832/DFB_Colour-Chart-2020.pdf
---------------	--------------------------------------------------------------------------------------------------------------------------------------------------------------------------------------------------------------------------------------------------------------------------------------------------------------------------------------------------------------------------------------------------------------------------------------------------------------

ACCESSORIES	<ul style="list-style-type: none"> > Master key > Cylinder extraction key > Cylinder for keylock > Additional metal shelf > Handle in various colors > Kit softclosing > Hanging files for under cabinet shelves, length: 330 mm
--------------------	----------------------------------------------------------------------------------------------------------------------------------------------------------------------------------------------------------------------------------------------------------------------------------------------------------------------------

NET WEIGHT	98,00 Kg
-------------------	----------

PACKAGING	<ul style="list-style-type: none"> > volume: 0,31 m³ > Plastic film in heat shrink > Cardboard corners and channel > Optimized for transport with CO2 reduction > Delivered: disassembled > Packages: 8
------------------	--------------------------------------------------------------------------------------------------------------------------------------------------------------------------------------------------------------------------------------------------------------------------------------------------

END OF USE	<ul style="list-style-type: none"> > Equipped with disassembly card for disposal
-------------------	----------------------------------------------------------------------------------------------------

WARRANTY	<ul style="list-style-type: none"> > Dieffebi guarantees that the product was made using high quality materials - See warranty document
-----------------	---------------------------------------------------------------------------------------------------------------------------------------------------------------------------

Primo Sliding Acoustic Doors

MADE IN ITALY

Sliding door cabinet W 1200
W 1200 x D 450 x H 2003 mm

DESIGNER Takiro Yuta

WELLNESS AND ENVIRONMENT > Green design in accordance with LEED® standards, to design and furnish environments with a high sustainability content



www.GreenTop.com



STRUCTURE TEST EN 14073-2:2004, par. 3.4
EN 14073-3:2004, par. 5.2
EN 14073-3:2004, par. 5.3.1
EN 14073-3:2004, par. 5.3.2
EN 14074:2004, par. 6.4.1
EN 14074:2004, par. 6.4.2
UNI8606:1984
EN 16122:2012 + AC:2015, par. 6.1.4

ACOUSTIC PERFORMANCE TEST UNI EN ISO 354/03
UNI EN ISO 11654/98
Alfaw 0,55 CLASSE D
ASMT C423 - 09A NCR 0,55
Test Zetalab - Cerea (VR)

FINISHING TEST UNI EN ISO 2409:2013
NSS UNI EN ISO 9227:2017
UNI EN 15187:2007 EN ISO 1520:2006
UNI EN ISO 6272-1:2013
UNI EN 15185:2011
UNI EN 15186:2012, met.B
UNI 9300:2015
EN 12720:2013
EN 12721:2013
UNI 9429:2015

CLASS OF REACTION TO FIRE > Class 0

POSITIONING > Both on the wall and in the center of the room



dieffebi



MADE IN EUROPE



ASSUFFICIO
ASSOCIAZIONE FIDELIENEGARRECO

ADIMEMBER



consip
acquistinretepa.it

Dieffebi SpA

T +39 0438 4715
F +39 0438 471600
exportsales@dieffebi.com
vendite@dieffebi.com
www.dieffebi.com

Primo Sliding Acoustic Doors

Varnish Vernici Vernis Lacke

Cabinet Body
Corpo
Caisson
Korpus



-V1
S711 (RAL 9010)
Pure white



-V6
S380 (RAL 9006)
White aluminium

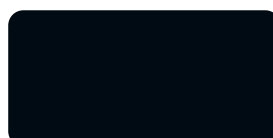

-V22
S811 (RAL 9005)
Jet black

Additional metal shelf
Ripiano aggiuntivo
in metallo
Tablette supplémentaire
en métal
Zusätzlicher
Metallfachboden



-V1
S711 (RAL 9010)
Pure white



-V6
S380 (RAL 9006)
White aluminium

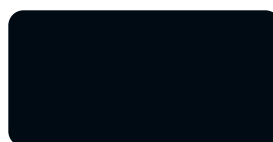

-V22
S811 (RAL 9005)
Jet black

Coloured handle
Maniglia colorata
Poignée couleur
Farbiger Griff



-V8
6013 (RAL 6013)
Green



-V15
1021 (RAL 1021)
Yellow



-V17
5024 (RAL 5024)
Pastel Blue



-V19
S210 (RAL 7021)
Black grey



-V24
3005 (RAL 3005)
Wine red