

Primo Cabinets 800

MADE IN ITALY

Armadio anta battente H 723
L 800 x P 450 x H 723 mm

V1	○	bianco	RAL 9010	art.6PRAK801P S711
V6	●	alluminio	RAL 9006	art.6PRAK801P S380
V22	●	nero	RAL 9005	art.6PRAK801P S811

DESIGNER Takiro Yuta

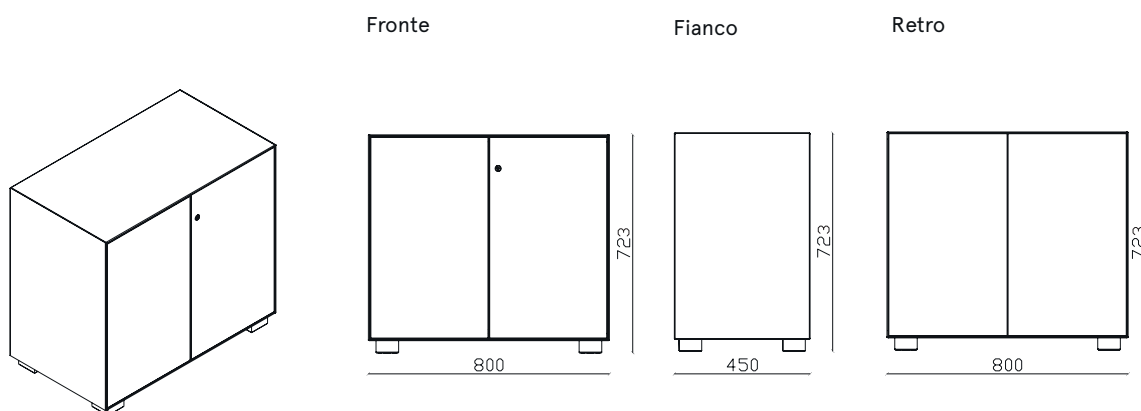

Primo Cabinets 800

MADE IN ITALY

Armadio anta battente H 723
L800 x P 450 x H 723 mm

DESIGNER Takiro Yuta

DESCRIZIONE	Armadio Contenitore ante a battente
DIMENSIONI ESTERNE	L 800 mm x P 450 mm x H 723 mm
DIMENSIONI INTERNE VANO	L 751 mm x P 400 mm x H 635 mm
DOX	Capienza Dox N°8
CARTELLINE	Capienza 60 cartelline
PRODUZIONE	<ul style="list-style-type: none"> > Dieffebi S.p.a. > Inizio produzione: anno 2012 > Luogo di produzione: Italia
MANUTENZIONE	<ul style="list-style-type: none"> > Pulire con panno morbido > Non trattare le superfici con panni abrasivi
MATERIALI	> struttura e ante: in metallo riciclato e riciclabile
FINITURA	<ul style="list-style-type: none"> > Verniciatura a polveri basso emissive (materiale inerte) > Esenti da metalli pesanti > Assenza di spigoli vivi e bordi taglienti > Finitura anti riflesso > Non contiene VOC
COMPONENTI STANDARD	<ul style="list-style-type: none"> > Serratura a cilindro con 2 chiavi (fissa +pieghevole) > Disponibile chiave master > Ripiani regolabili: in metallo predisposti per cartelle sospese > N° 1 ripiano incluso > Portata ripiani: 50 Kg > Piedini regolabili H 40mm > Viti per assemblaggio

COLORI	<ul style="list-style-type: none"> > Disponibile in 3 colori standard V1 Bianco (RAL 9010) V6 Alluminio (RAL 9006) V22 Nero (RAL9005) > Colori standard semilucidi > Colori personalizzabili su richiesta previa disponibilità e con sovrapprezzo: www.dieffebi.com/docs/299/2832/DFB_Colour-Chart-2020.pdf
---------------	--

ACCESSORI	<ul style="list-style-type: none"> > Top in vetro laccato bianco RAL 9010 > Chiave Master > Ripiano aggiuntivo in metallo > Zoccolo H 40mm > Telaio singolo estraibile e telescopico > Kit predisposizione cartelle sospese sotto top > Cartelline sospese per ripiano armadio Lungh. 330mm > Cartelline sospese per telaio armadio Lungh. 390mm > Set 4 piedini H20mm > Set Piedini H 60mm > Kit 4 cerniere con chiusura ammortizzata > Personalizzabili con ante in legno del cliente
------------------	---

PESO NETTO	30,00 Kg
-------------------	----------

IMBALLO	<ul style="list-style-type: none"> > volume: 0,09 m³ > Film plastico in termoretaibile > Angolari e canale in cartone > Ottimizzato per il trasporto con riduzione di CO2 > Fornito: Smontato, > Fornito: Montato con supplemento di prezzo. costo di spedizione non incluso > N°colli: 6
----------------	--

END OF USE	> Corredato di scheda di disassemblaggio per smaltimento.
-------------------	---

GARANZIA	> Dieffebi garantisce che il prodotto è stato realizzato usando materiali di alta qualità - Vedi documento di garanzia.
-----------------	---

Primo Cabinets 800

MADE IN ITALY

Armadio anta battente H 723
L 800 x P 450 x H 723 mm

DESIGNER Takiro Yuta

BENESSERE E AMBIENTE > Design "green" in accordo con gli standard LEED®, per progettare ed arredare ambienti ad alto contenuto di sostenibilità.



www.GreenTop.com



TEST STRUTTURA TEST:

EN 14073-2:2004, par. 3.4
EN 14073-3:2004, par. 5.2
EN 14073-3:2004, par. 5.3.1
EN 14073-3:2004, par. 5.3.2
EN 14073-3:2004, par. 5.5
EN 14074:2004, par. 6.3.1
EN 14074:2004, par. 6.3.2
EN 14074:2004, par. 6.3.3
UNI 8601:1984
UNI 8606:1984

TEST FINITURA

UNI EN ISO 2409:2013
NSS UNI EN ISO 9227:2017
UNI EN 15187:2007 EN ISO 1520:2006
UNI EN ISO 6272-1:2013
UNI EN 15185:2011
UNI EN 15186:2012, met.B
UNI 9300:2015
EN 12720:2013
EN 12721:2013
UNI 9429:2015

CLASSE DI REAZIONE AL FUOCO > Classe 0

POSIZIONAMENTO > Sia a muro che in centro stanza



dieffebi



MADE IN EUROPE



ASSUFFICIO
ASSOCIAZIONE FEDERLEGGIARREDO

ADIMEMBER



consip
acquistinretepa.it
Il Fornitore Aggiuntivo della Pubblica Amministrazione

Dieffebi SpA

via Palù 36
San Vendemiano,
31020 Treviso - Italia

T +39 0438 4715
F +39 0438 471600
exportsales@dieffebi.com
vendite@dieffebi.com
www.dieffebi.com

Primo Cabinets 800

Vernici
Varnish
Vernis
Lacke

Corpo
Cabinet Body
Caisson
Korpus



-V1
S711 (RAL 9010)
Pure white



-V6
S380 (RAL 9006)
White aluminium



-V22
S811 (RAL 9005)
Jet black

Ripiano aggiuntivo
in metallo
Additional metal shelf
Tablette supplémentaire
en métal
Zusätzlicher
Metallfachboden

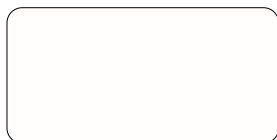

-V1
S711 (RAL 9010)
Pure white



-V6
S380 (RAL 9006)
White aluminium

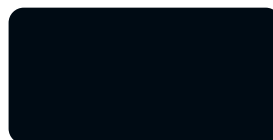

-V22
S811 (RAL 9005)
Jet black

Zoccolo
Plinth
Socle
Sockel

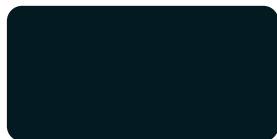

-V19
S210 (RAL 7021)
Black grey

Telaio singolo
Single pullout frame
Cadre extractible
Ausziehbarer
Hängemappenrahmen



-V6
S380 (RAL 9006)
White aluminium

Kit predisposizione cartelle
sospese sotto top
Kit for hanging files under top
of cabinets
Jeu de rails pour dossier
suspendu sous plateau
Set Hängemappenrahmen
unter Platte



-V1
S711 (RAL 9010)
Pure white



-V6
S380 (RAL 9006)
White aluminium

Primo Cabinets 800

Vetro
Glass
Verre
Glas

Top di finitura in vetro
laccato bianco
White lacquered glass top
Plateau en verre laqué
blanc
Glasabdeckplatte weiß
lackiert

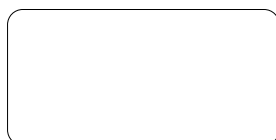

-G1
Bianco/White/Blanc/Weiß

Primo Cabinets 800

MADE IN ITALY

Armadio anta battente H 743
L 800 x P 450 x H 743 mm

V1	○	bianco	RAL 9010	art.6PRAK801F S711
V6	●	alluminio	RAL 9006	art.6PRAK801F S380
V22	●	nero	RAL 9005	art.6PRAK801F S811

DESIGNER Takiro Yuta

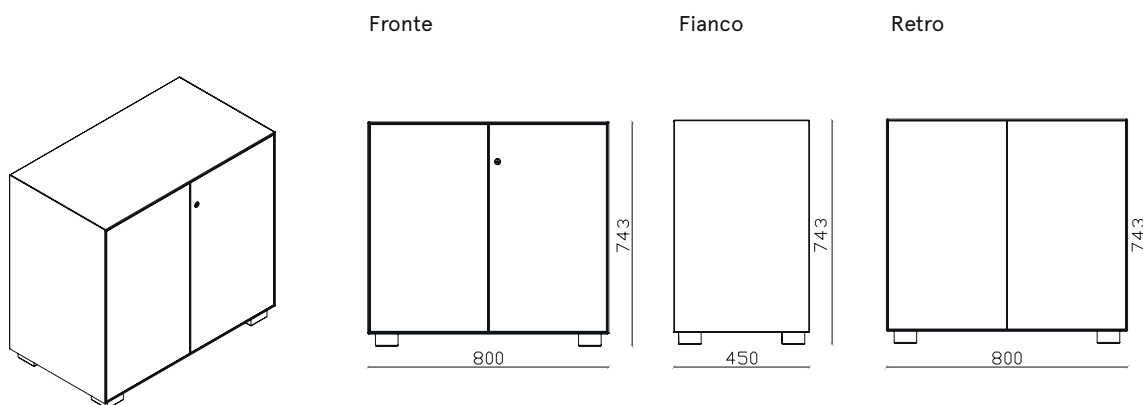

Primo Cabinets 800

MADE IN ITALY

Armadio anta battente H 743
L800 x P 450 x H 743 mm

DESIGNER Takiro Yuta

DESCRIZIONE	Armadio Contenitore ante a battente
DIMENSIONI ESTERNE	L 800 mm x P 450 mm x H 743 mm
DIMENSIONI INTERNE VANO	L 751 mm x P 400 mm x H 635 mm
DOX	Capienza Dox N°8
CARTELLINE	Capienza 60 cartelline
PRODUZIONE	<ul style="list-style-type: none"> > Dieffebi S.p.a. > Inizio produzione: anno 2012 > Luogo di produzione: Italia
MANUTENZIONE	<ul style="list-style-type: none"> > Pulire con panno morbido > Non trattare le superfici con panni abrasivi
MATERIALI	> struttura e ante: in metallo riciclato e riciclabile
FINITURA	<ul style="list-style-type: none"> > Verniciatura a polveri basso emissive (materiale inerte) > Esenti da metalli pesanti > Assenza di spigoli vivi e bordi taglienti > Finitura anti riflesso > Non contiene VOC
COMPONENTI STANDARD	<ul style="list-style-type: none"> > Serratura a cilindro con 2 chiavi (fissa +pieghevole) > Disponibile chiave master > Ripiani regolabili: in metallo predisposti per cartelle sospese > N° 1 ripiano incluso > Portata ripiani: 50 Kg > Piedini regolabili H 40mm > Viti per assemblaggio

COLORI	<ul style="list-style-type: none"> > Disponibile in 3 colori standard V1 Bianco (RAL 9010) V6 Alluminio (RAL 9006) V22 Nero (RAL9005) > Colori standard semilucidi > Colori personalizzabili su richiesta previa disponibilità e con sovrapprezzo: www.dieffebi.com/docs/299/2832/DFB_Colour-Chart-2020.pdf
---------------	--

ACCESSORI	<ul style="list-style-type: none"> > Top in vetro laccato bianco RAL 9010 > Chiave Master > Ripiano aggiuntivo in metallo > Zoccolo H 40mm > Telaio singolo estraibile e telescopico > Kit predisposizione cartelle sospese sotto top > Cartelline sospese per ripiano armadio Lungh. 330mm > Cartelline sospese per telaio armadio Lungh. 390mm > Set 4 piedini H20mm > Set Piedini H 60mm > Kit 4 cerniere con chiusura ammortizzata > Personalizzabili con ante in legno del cliente
------------------	---

PESO NETTO 30,00 Kg

IMBALLO	<ul style="list-style-type: none"> > volume: 0,09 m³ > Film plastico in termoretaibile > Angolari e canale in cartone > Ottimizzato per il trasporto con riduzione di CO2 > Fornito: Smontato, > Fornito: Montato con supplemento di prezzo. costo di spedizione non incluso > N°colli: 6
----------------	--

END OF USE > Corredato di scheda di disassemblaggio per smaltimento.

GARANZIA > Dieffebi garantisce che il prodotto è stato realizzato usando materiali di alta qualità - [Vedi documento di garanzia.](#)

Primo Cabinets 800

MADE IN ITALY

Armadio anta battente H 743
L 800 x P 450 x H 743 mm

DESIGNER Takiro Yuta

BENESSERE E AMBIENTE > Design "green" in accordo con gli standard LEED®, per progettare ed arredare ambienti ad alto contenuto di sostenibilità.



www.GreenTop.com



TEST STRUTTURA TEST:

EN 14073-2:2004, par. 3.4
EN 14073-3:2004, par. 5.2
EN 14073-3:2004, par. 5.3.1
EN 14073-3:2004, par. 5.3.2
EN 14073-3:2004, par. 5.5
EN 14074:2004, par. 6.3.1
EN 14074:2004, par. 6.3.2
EN 14074:2004, par. 6.3.3
UNI 8601:1984
UNI 8606:1984

TEST FINITURA

UNI EN ISO 2409:2013
NSS UNI EN ISO 9227:2017
UNI EN 15187:2007 EN ISO 1520:2006
UNI EN ISO 6272-1:2013
UNI EN 15185:2011
UNI EN 15186:2012, met.B
UNI 9300:2015
EN 12720:2013
EN 12721:2013
UNI 9429:2015

CLASSE DI REAZIONE AL FUOCO > Classe 0

POSIZIONAMENTO > Sia a muro che in centro stanza



dieffebi



MADE IN EUROPE



ASSUFFICIO
ASSOCIAZIONE FEDERLEGGIDARREDI

ADIMEMBER



consip
acquistinretepa.it
Il Fornitore Aggiunto della Pubblica Amministrazione

Dieffebi SpA

T +39 0438 4715
F +39 0438 471600
exportsales@dieffebi.com
vendite@dieffebi.com
www.dieffebi.com

Primo Cabinets 800

Vernici Varnish Vernis Lacke

Corpo
Cabinet Body
Caisson
Korpus



-V1
S711 (RAL 9010)
Pure white



-V6
S380 (RAL 9006)
White aluminium



-V22
S811 (RAL 9005)
Jet black

Ripiano aggiuntivo
in metallo
Additional metal shelf
Tablette supplémentaire
en métal
Zusätzlicher
Metallfachboden

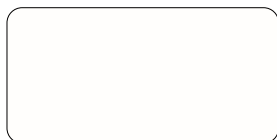

-V1
S711 (RAL 9010)
Pure white



-V6
S380 (RAL 9006)
White aluminium

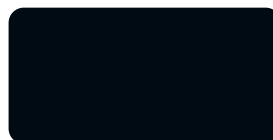

-V22
S811 (RAL 9005)
Jet black

Zoccolo
Plinth
Socle
Sockel

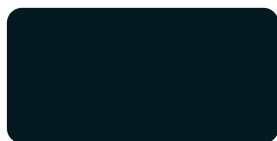

-V19
S210 (RAL 7021)
Black grey

Telaio singolo
Single pullout frame
Cadre extractible
Ausziehbarer
Hängemappenrahmen



-V6
S380 (RAL 9006)
White aluminium

Kit predisposizione cartelle
sospese sotto top
Kit for hanging files under top
of cabinets
Jeu de rails pour dossier
suspendu sous plateau
Set Hängemappenrahmen
unter Platte



-V1
S711 (RAL 9010)
Pure white



-V6
S380 (RAL 9006)
White aluminium

Primo Cabinets 800

Vetro
Glass
Verre
Glas

Top di finitura in vetro
laccato bianco
White lacquered glass top
Plateau en verre laqué
blanc
Glasabdeckplatte weiß
lackiert



-G1
Bianco/White/Blanc/Weiß

Primo Cabinets 800

MADE IN ITALY

Armadio anta battente H 883
L 800 x P 450 x H 883 mm

V1	○	bianco	RAL 9010	art.6PRAK802P S711
V6	●	alluminio	RAL 9006	art.6PRAK802P S380
V22	●	nero	RAL 9005	art.6PRAK802P S811

DESIGNER Takiro Yuta

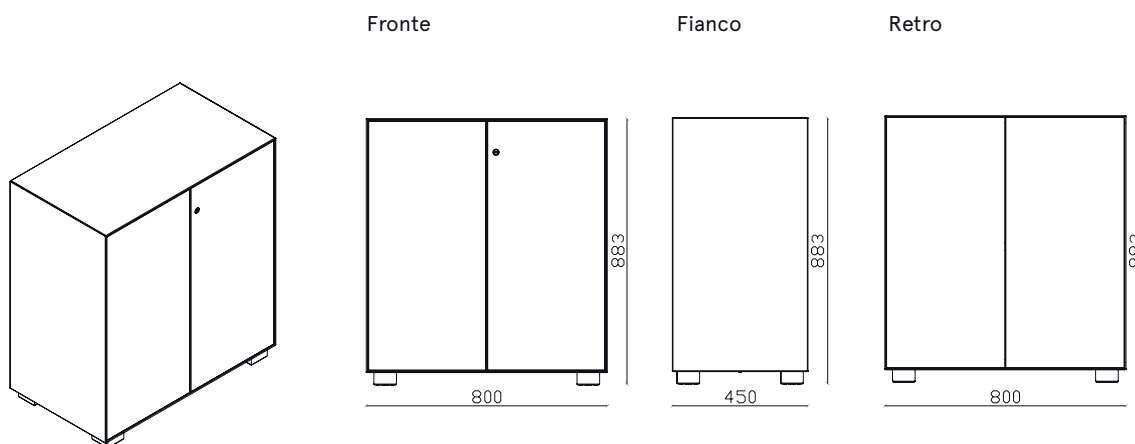

Primo Cabinets 800

MADE IN ITALY

Armadio anta battente H 883
L800 x P 450 x H 883 mm

DESIGNER Takiro Yuta

DESCRIZIONE	Armadio Contenitore ante a battente	COLORI	> Disponibile in 3 colori standard V1 Bianco (RAL 9010) V6 Alluminio (RAL 9006) V22 Nero (RAL9005) > Colori standard semilucidi > Colori personalizzabili su richiesta previa disponibilità e con sovrapprezzo: www.dieffebi.com/docs/299/2832/DFB_Colour-Chart-2020.pdf
DIMENSIONI ESTERNE	L 800 mm x P 450 mm x H 883 mm	ACCESSORI	> Top in vetro laccato bianco RAL 9010 > Chiave Master > Ripiano aggiuntivo in metallo > Zoccolo H 40mm > Telaio singolo estraibile e telescopico > Kit 2 telai estraibili e telescopici con guide ad estrazione totale e sistema di estrazione selettiva 35Kg > Kit predisposizione cartelle sospese sotto top > Cartelline sospese per ripiano armadio Lungh. 330mm > Cartelline sospese per telaio armadio Lungh. 390mm > Set 4 piedini H20mm > Set Piedini H 60mm > Kit 4 cerniere con chiusura ammortizzata > Personalizzabili con ante in legno del cliente
DIMENSIONI INTERNE VANO	L 751 mm x P 400 mm x H 795 mm	PESO NETTO	32,70 Kg
DOX	Capienza Dox N°8(x2)	IMBALLO	> volume: 0,1 m ³ > Film plastico in termoretaibile > Angolari e canale in cartone > Ottimizzato per il trasporto con riduzione di CO2 > Fornito: Smontato, > Fornito: Montato con supplemento di prezzo. costo di spedizione non incluso > N°colli: 6
CARTELLINE	Capienza 60 cartelline	END OF USE	> Corredato di scheda di disassemblaggio per smaltimento.
PRODUZIONE	> Dieffebi S.p.a. > Inizio produzione: anno 2012 > Luogo di produzione: Italia	GARANZIA	> Dieffebi garantisce che il prodotto è stato realizzato usando materiali di alta qualità - Vedi documento di garanzia.
MANUTENZIONE	> Pulire con panno morbido > Non trattare le superfici con panni abrasivi		
MATERIALI	> struttura e ante: in metallo riciclato e riciclabile		
FINITURA	> Verniciatura a polveri basso emissive (materiale inerte) > Esenti da metalli pesanti > Assenza di spigoli vivi e bordi taglienti > Finitura anti riflesso > Non contiene VOC		
COMPONENTI STANDARD	> Serratura a cilindro con 2 chiavi (fissa +pieghevole) > Disponibile chiave master > Ripiani regolabili: in metallo predisposti per cartelle sospese > N° 1 ripiano incluso > Portata ripiani: 50 Kg > Piedini regolabili H 40mm > Viti per assemblaggio		

Primo Cabinets 800

MADE IN ITALY

Armadio anta battente H 883
L 800 x P 450 x H 883 mm

DESIGNER Takiro Yuta

BENESSERE E AMBIENTE > Design "green" in accordo con gli standard LEED®, per progettare ed arredare ambienti ad alto contenuto di sostenibilità.



www.GreenTop.com



TEST STRUTTURA TEST:

EN 14073-2:2004, par. 3.4
EN 14073-3:2004, par. 5.2
EN 14073-3:2004, par. 5.3.1
EN 14073-3:2004, par. 5.3.2
EN 14073-3:2004, par. 5.5
EN 14074:2004, par. 6.3.1
EN 14074:2004, par. 6.3.2
EN 14074:2004, par. 6.3.3
UNI 8601:1984
UNI 8606:1984

TEST FINITURA

UNI EN ISO 2409:2013
NSS UNI EN ISO 9227:2017
UNI EN 15187:2007 EN ISO 1520:2006
UNI EN ISO 6272-1:2013
UNI EN 15185:2011
UNI EN 15186:2012, met.B
UNI 9300:2015
EN 12720:2013
EN 12721:2013
UNI 9429:2015

CLASSE DI REAZIONE AL FUOCO > Classe 0

POSIZIONAMENTO > Sia a muro che in centro stanza



dieffebi



MADE IN EUROPE



ASSUFFICIO
ASSOCIAZIONE FEDERLEGGIDARREDI

ADIMEMBER



consip
acquistinretepa.it
Il Fornitore Aggiunto della Pubblica Amministrazione

Dieffebi SpA

via Palù 36
San Vendemiano,
31020 Treviso - Italia

T +39 0438 4715
F +39 0438 471600
exportsales@dieffebi.com
vendite@dieffebi.com
www.dieffebi.com

Primo Cabinets 800

Vernici
Varnish
Vernis
Lacke

Corpo
Cabinet Body
Caisson
Korpus



-V1
S711 (RAL 9010)
Pure white



-V6
S380 (RAL 9006)
White aluminium



-V22
S811 (RAL 9005)
Jet black

Ripiano aggiuntivo
in metallo
Additional metal shelf
Tablette supplémentaire
en métal
Zusätzlicher
Metallfachboden

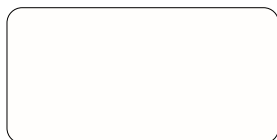

-V1
S711 (RAL 9010)
Pure white



-V6
S380 (RAL 9006)
White aluminium

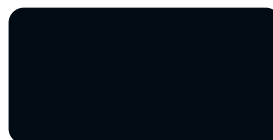

-V22
S811 (RAL 9005)
Jet black

Zoccolo
Plinth
Socle
Sockel

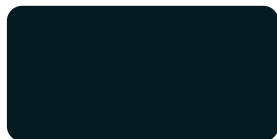

-V19
S210 (RAL 7021)
Black grey

Telaio singolo
Single pullout frame
Cadre extractible
Ausziehbarer
Hängemappenrahmen



-V6
S380 (RAL 9006)
White aluminium

Kit predisposizione cartelle
sospese sotto top
Kit for hanging files under top
of cabinets
Jeu de rails pour dossier
suspendu sous plateau
Set Hängemappenrahmen
unter Platte



-V1
S711 (RAL 9010)
Pure white



-V6
S380 (RAL 9006)
White aluminium

Kit 2 telai estraibili
Set of 2 pullout frames
Jeu de 2 cadres extractibles
Set 2 ausziehbare
Hängemappenrahmen



-V6
S380 (RAL 9006)
White aluminium

Primo Cabinets 800

Vetro
Glass
Verre
Glas

Top di finitura in vetro
laccato bianco
White lacquered glass top
Plateau en verre laqué
blanc
Glasabdeckplatte weiß
lackiert



-G1
Bianco/White/Blanc/Weiß

Primo Cabinets 800

MADE IN ITALY

Hinged door cabinet H 1011
L 800 x W 450 x H 1011 mm

V1  white

V6  aluminium

V22  black

RAL 9010

RAL 9006

RAL 9005

art.6PRAK803P S711

art.6PRAK803P S380

art.6PRAK803P S811

DESIGNER Takiro Yuta

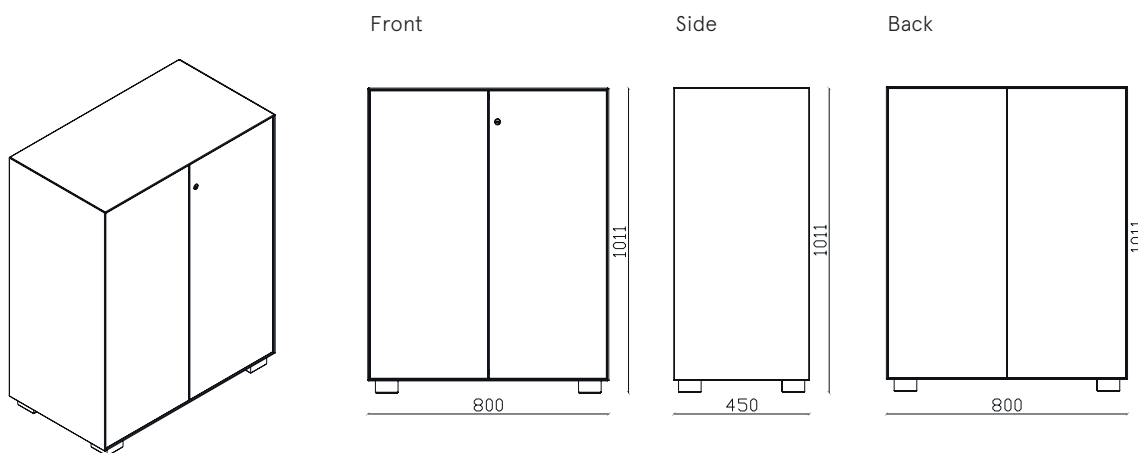

Primo Cabinets 800

MADE IN ITALY

Hinged door cabinet H 1011
L800 x W 450 x H 1011 mm

DESIGNER Takiro Yuta

DESCRIPTION	Hinged door cabinet	COLORS	<ul style="list-style-type: none"> > Available in 3 standard colors: V1 White (RAL 9010) V6 Aluminium (RAL 9006) V22 Black (RAL 9005) > Standard semi-gloss colors > Customizable colors available upon request and with an extra charge: www.dieffebi.com/docs/299/2832/DFB_Colour-Chart-2020.pdf
EXTERNAL DIMENSIONS	L 800 mm x W 450 mm x H 1011 mm	ACCESSORIES	<ul style="list-style-type: none"> > White lacquered glass top RAL 9010 > Master key > Additional metal shelf > Plinth H 40mm > Single pullout and telescopic frame > Set of 2 pullout and telescopic frames with full extension guides and 35Kg selective extraction system > Kit for hanging files under top of cabinets > Hanging files for under cabinet shelves, length: 330 mm > Hanging files for under cabinet shelves, length: 390 mm > Set of 4 feet H 20mm > Set of 4 feet H 60 mm > Kit of 4 soft closing hinges > Customizable with customer's wooden doors
INTERNAL DIMENSIONS	L 751 mm x W 400 mm x H 923 mm	NET WEIGHT	35,60 Kg
DOX	Dox capacity: 8(x2)	PACKAGING	<ul style="list-style-type: none"> > Volume: 0,11 m³ > Plastic film in heat shrink > Cardboard corners and channel > Optimized for transport with CO2 reduction > Delivered: disassembled, > Delivered: assembled with an extra charge, shipping cost not included > Packages: 6
HANGING FILES	Capacity: 60 hanging files	END OF USE	> Equipped with disassembly card for disposal
PRODUCTION	<ul style="list-style-type: none"> > Dieffebi S.p.a. > Beginning of production: 2012 > Country of production: Italy 	WARRANTY	> Dieffebi guarantees that the product was made using high quality materials - See warranty document
MAINTENANCE	<ul style="list-style-type: none"> > Clean with a soft cloth > Do not treat the surfaces with abrasive cloths 		
MATERIALS	> Structure and doors made of recycled and recyclable metal		
FINISHING	<ul style="list-style-type: none"> > Low-emission powder coating (material inert) > Free from heavy metals > Absence of sharp edges > Anti-glare finish > It does not contain VOCs 		
STANDARD COMPONENTS	<ul style="list-style-type: none"> > Cylinder lock with 2 keys (fixed + foldable) > Master key available > Adjustable metal shelves equipped for hanging files > N ° 2 shelves included > Shelf load capacity: 50 Kg > Adjustable feet H 40 mm > Assembly screws 		

Primo Cabinets 800

MADE IN ITALY

Hinged door cabinet H 1011
L 800 x W 450 x H 1011 mm

DESIGNER Takiro Yuta

WELLNESS AND ENVIRONMENT > Green design in accordance with LEED® standards, to design and furnish environments with a high sustainability content



www.GreenTop.com



STRUCTURE TEST TEST:

EN 14073-2:2004, par. 3.4
EN 14073-3:2004, par. 5.2
EN 14073-3:2004, par. 5.3.1
EN 14073-3:2004, par. 5.3.2
EN 14073-3:2004, par. 5.5
EN 14074:2004, par. 6.3.1
EN 14074:2004, par. 6.3.2
EN 14074:2004, par. 6.3.3
UNI 8601:1984
UNI8606:1984

FINISHING TEST UNI EN ISO 2409:2013
NSS UNI EN ISO 9227:2017
UNI EN 15187:2007 EN ISO 1520:2006
UNI EN ISO 6272-1:2013
UNI EN 15185:2011
UNI EN 15186:2012, met.B
UNI 9300:2015
EN 12720:2013
EN 12721:2013
UNI 9429:2015

CLASS OF REACTION TO FIRE > Class 0

POSITIONING > Both on the wall and in the center of the room



dieffebi



MADE IN EUROPE



ASSUFFICIO
ASSOCIAZIONE FEDERLEASINGARREDO

ADIMEMBER



consip
acquistinretepa.it

Dieffebi SpA

via Palù 36
San Vendemiano,
31020 Treviso - Italia

T +39 0438 4715
F +39 0438 471600
exportsales@dieffebi.com
vendite@dieffebi.com
www.dieffebi.com

Primo Cabinets 800

Varnish
Vernici
Vernis
Lacke

Cabinet Body
Corpo
Caisson
Korpus

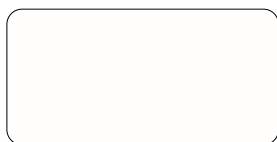

-V1
S711 (RAL 9010)
Pure white



-V6
S380 (RAL 9006)
White aluminium

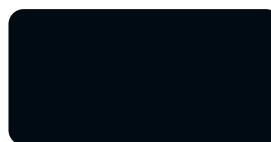

-V22
S811 (RAL 9005)
Jet black

Additional metal shelf
Ripiano aggiuntivo
in metallo
Tablette supplémentaire
en métal
Zusätzlicher
Metallfachboden

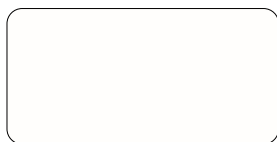

-V1
S711 (RAL 9010)
Pure white



-V6
S380 (RAL 9006)
White aluminium

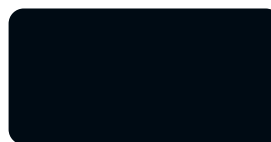

-V22
S811 (RAL 9005)
Jet black

Plinth
Zoccolo
Socle
Sockel

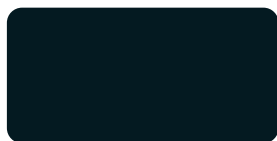

-V19
S210 (RAL 7021)
Black grey

Single pullout frame
Telaio singolo
Cadre extractible
Ausziehbarer
Hängemappenrahmen



-V6
S380 (RAL 9006)
White aluminium

Kit for hanging files under top
of cabinets
Kit predisposizione cartelle
sospese sotto top
Jeu de rails pour dossier
suspendu sous plateau
Set Hängemappenrahmen
unter Platte

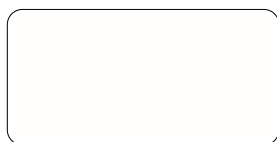

-V1
S711 (RAL 9010)
Pure white



-V6
S380 (RAL 9006)
White aluminium

Primo Cabinets 800

Glass
Vetro
Verre
Glas

White lacquered glass top

Top di finitura in vetro

laccato bianco

Plateau en verre laqué

blanc

Glasabdeckplatte weiß

lackiert

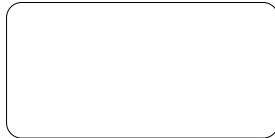

-G1

Bianco/White/Blanc/Weiß

Primo Cabinets 800

MADE IN ITALY

Armadio anta battente H 1171
L 800 x P 450 x H 1171 mm

V1 ○ bianco
V6 ● alluminio
V22 ● nero

RAL 9010
RAL 9006
RAL 9005

art.6PRAK804P S711
art.6PRAK804P S380
art.6PRAK804P S811

DESIGNER Takiro Yuta

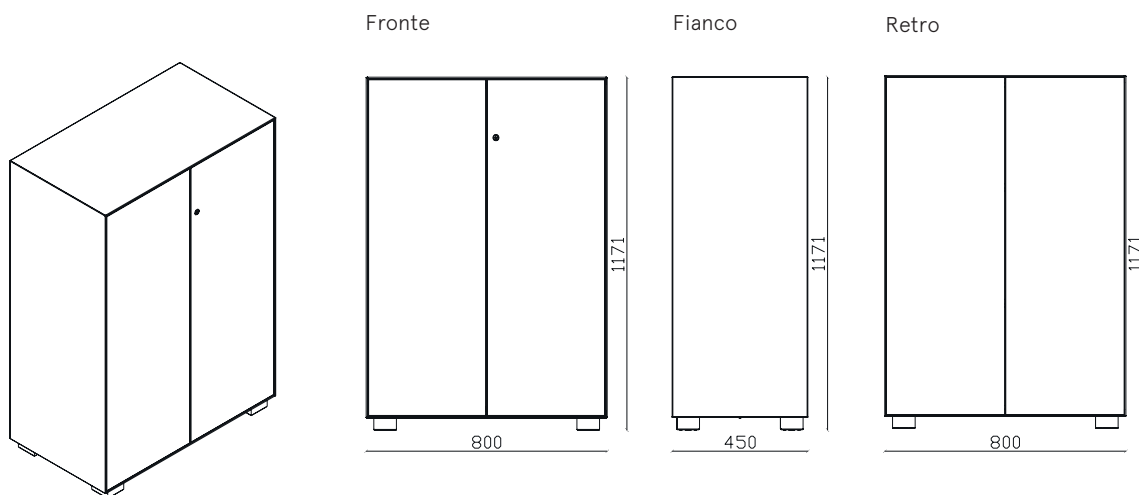

Primo Cabinets 800

MADE IN ITALY

Armadio anta battente H 1171
L 800 x P 450 x H 1171 mm

DESIGNER Takiro Yuta

DESCRIZIONE	Armadio anta battente
DIMENSIONI ESTERNE	L 800 mm x P 450 mm x H 1171 mm
DIMENSIONI INTERNE VANO	L 751 mm x P 400 mm x H 1083 mm
DOX	Capacità: 8(x3)
CARTELLINE	Capacità: 60 (x2) cartelline sospese
PRODUZIONE	<ul style="list-style-type: none"> > Dieffebi S.p.a. > Inizio di produzione: anno 2012 > Paese di produzione: Italia
MANUTENZIONE	<ul style="list-style-type: none"> > Pulire con panno morbido > Non trattare le superfici con panni abrasivi
MATERIALI	> struttura e ante: in metallo riciclato e riciclabile
FINITURA	<ul style="list-style-type: none"> > Verniciatura a polveri basso emissive (materiale inerte) > Esenti da metalli pesanti > Assenza di spigoli vivi e bordi taglienti > Finitura anti riflesso > Non contiene VOC
COMPONENTI STANDARD	<ul style="list-style-type: none"> > Serratura a cilindro con 2 chiavi (fissa +pieghevole) > Disponibile chiave master > Ripiani regolabili: in metallo predisposti per cartelle sospese > N° 2 ripiani inclusi > Portata ripiani: 50 Kg > Piedini regolabili H 40mm > Viti per assemblaggio
GARANZIA	> Dieffebi garantisce che il prodotto è stato realizzato usando materiali di alta qualità - Vedi documento di garanzia.

COLORI	<ul style="list-style-type: none"> > Disponibile in 3 colori standard V1 Bianco (RAL 9010) V6 Alluminio (RAL 9006) V22 Nero (RAL9005) > Colori standard semilucidi > Colori personalizzabili su richiesta previa disponibilità e con sovrapprezzo: www.dieffebi.com/docs/299/2832/DFB_Colour-Chart-2020.pdf
ACCESSORI	<ul style="list-style-type: none"> > Top in vetro laccato bianco RAL 9010 > Chiave Master > Ripiano aggiuntivo in metallo > Appendiabiti > Zoccolo H 40mm > Telaio singolo estraibile e telescopico > Kit 2 telai estraibili e telescopici con guide ad estrazione totale e sistema di estrazione selettiva 35Kg > Kit predisposizione cartelle sospese sotto top > Cartelline sospese per ripiano armadio Lungh. 330mm > Cartelline sospese per telaio armadio Lungh. 390mm > Set 4 piedini H20mm > Set Piedini H 60mm > Kit 4 cerniere con chiusura ammortizzata > Kit 6 cerniere con chiusura ammortizzata > Personalizzabili con ante in legno del cliente
PESO NETTO	41,4 Kg
IMBALLO	<ul style="list-style-type: none"> > Volume: 0,13 m³ > Film plastico in termoretaibile > Angolari e canale in cartone > Ottimizzato per il trasporto con riduzione di CO2 > Fornito: Smontato, > Fornito: Montato con supplemento di prezzo. costo di spedizione non incluso > N° colli: 6
END OF USE	> Corredato di scheda di disassemblaggio per smaltimento.

Primo Cabinets 800

MADE IN ITALY

Armadio anta battente H 1171

L 800 x P 450 x H 1171 mm

DESIGNER Takiro Yuta

BENESSERE E AMBIENTE > Design "green" in accordo con gli standard LEED®, per progettare ed arredare ambienti ad alto contenuto di sostenibilità.



www.GreenTop.com



TEST STRUTTURA TEST:

EN 14073-2:2004, par. 3.4
 EN 14073-3:2004, par. 5.2
 EN 14073-3:2004, par. 5.3.1
 EN 14073-3:2004, par. 5.3.2
 EN 14073-3:2004, par. 5.5
 EN 14074:2004, par. 6.3.1
 EN 14074:2004, par. 6.3.2
 EN 14074:2004, par. 6.3.3
 UNI 8601:1984
 UNI 8606:1984

TEST FINITURA

UNI EN ISO 2409:2013
 NSS UNI EN ISO 9227:2017
 UNI EN 15187:2007 EN ISO 1520:2006
 UNI EN ISO 6272-1:2013
 UNI EN 15185:2011
 UNI EN 15186:2012, met.B
 UNI 9300:2015
 EN 12720:2013
 EN 12721:2013
 UNI 9429:2015

CLASSE DI REAZIONE AL FUOCO > Classe O

POSIZIONAMENTO > Sia a muro che in centro stanza



dieffebi



MADE IN EUROPE



ASSUFFICIO
 ASSOCIAZIONE FEDERLEGGIDARREDI

ADIMEMBER



consip
 acquistinretepa.it
Il Fornitore Aggiuntivo della Pubblica Amministrazione

Dieffebi SpA

via Palù 36
 San Vendemiano,
 31020 Treviso - Italia

T +39 0438 4715
 F +39 0438 471600
 exportsales@dieffebi.com
 vendite@dieffebi.com
 www.dieffebi.com

Primo Cabinets 800

Vernici
Lacke
Varnish
Vernis

Corpo
Korpus
Cabinet Body
Caisson



-V1
S711 (RAL 9010)
Pure white



-V6
S380 (RAL 9006)
White aluminium

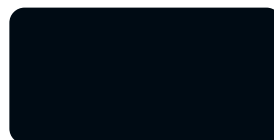

-V22
S811 (RAL 9005)
Jet black

Ripiano aggiuntivo
in metallo
Zusätzlicher
Metallfachboden
Additional metal shelf
Tablette supplémentaire
en métal



-V1
S711 (RAL 9010)
Pure white



-V6
S380 (RAL 9006)
White aluminium



-V22
S811 (RAL 9005)
Jet black

Zoccolo
Sockel
Plinth
Socle

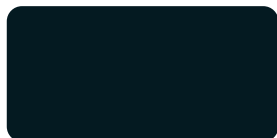

-V19
S210 (RAL 7021)
Black grey

Telaio singolo
Ausziehbarer
Hängemappenrahmen
Single pullout frame
Cadre extractible



-V6
S380 (RAL 9006)
White aluminium

Kit predisposizione cartelle
sospese sotto top
Set Hängemappenrahmen
unter Platte
Kit for hanging files under top
of cabinets
Jeu de rails pour dossier
suspendu sous plateau



-V1
S711 (RAL 9010)
Pure white



-V6
S380 (RAL 9006)
White aluminium

Primo Cabinets 800

Vetro
Glas
Glass
Verre

Top di finitura in vetro
laccato bianco
Glasabdeckplatte weiß
lackiert
White lacquered glass top
Plateau en verre laqué
blanc



-G1
Bianco/White/Blanc/Weiß

Primo Cabinets 800

MADE IN ITALY

Armadio anta battente H 1331
L 800 x P 450 x H 1331 mm

V1 ○ bianco
V6 ● alluminio
V22 ● nero

RAL 9010 art.6PRAK805P S711
RAL 9006 art.6PRAK805P S380
RAL 9005 art.6PRAK805P S811

DESIGNER Takiro Yuta

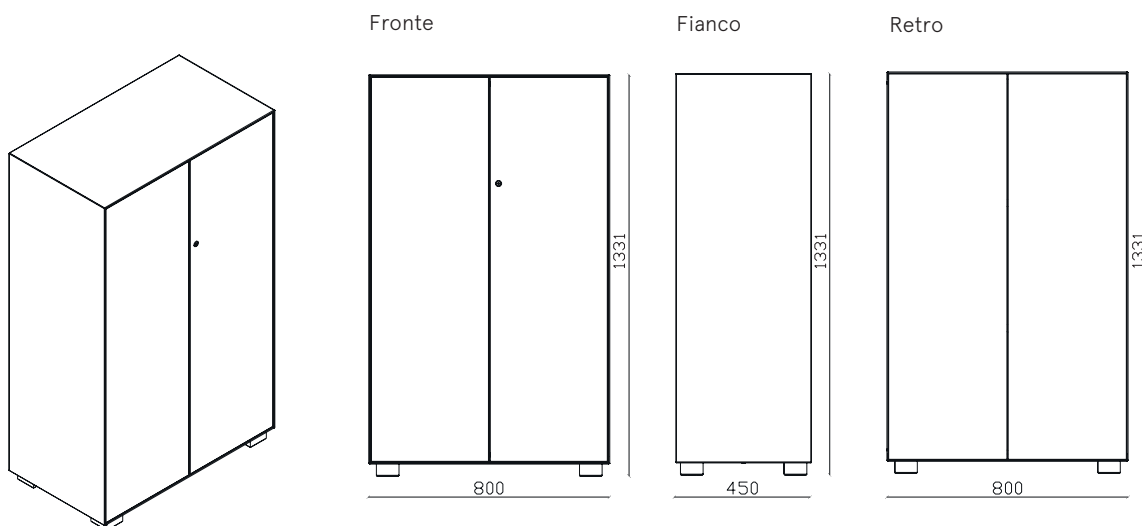

Primo Cabinets 800

MADE IN ITALY

Armadio anta battente H 1331

L 800 x P 450 x H 1331 mm

DESIGNER Takiro Yuta

DESCRIZIONE	Armadio anta battente
DIMENSIONI ESTERNE	L 800 mm x P 450 mm x H 1331 mm
DIMENSIONI INTERNE VANO	L 751 mm x P 400 mm x H 1243 mm
DOX	Capacità: N°8(x3)
CARTELLINE	Capacità: 60(x2) cartelline sospese
PRODUZIONE	<ul style="list-style-type: none"> > Dieffebi S.p.a. > Inizio di produzione: anno 2012 > Paese di produzione: Italia
MANUTENZIONE	<ul style="list-style-type: none"> > Pulire con panno morbido > Non trattare le superfici con panni abrasivi
MATERIALI	> struttura e ante: in metallo riciclato e riciclabile
FINITURA	<ul style="list-style-type: none"> > Verniciatura a polveri basso emissive (materiale inerte) > Esenti da metalli pesanti > Assenza di spigoli vivi e bordi taglienti > Finitura anti riflesso > Non contiene VOC
COMPONENTI STANDARD	<ul style="list-style-type: none"> > Serratura a cilindro con 2 chiavi (fissa +pieghevole) > Disponibile chiave master > Ripiani regolabili: in metallo predisposti per cartelle sospese > N° 2 ripiani inclusi > Portata ripiani: 50 Kg > Piedini regolabili H 40mm > Viti per assemblaggio
GARANZIA	> Dieffebi garantisce che il prodotto è stato realizzato usando materiali di alta qualità - Vedi documento di garanzia.

COLORI	<ul style="list-style-type: none"> > Disponibile in 3 colori standard V1 Bianco (RAL 9010) V6 Alluminio (RAL 9006) V22 Nero (RAL9005) > Colori standard semilucidi > Colori personalizzabili su richiesta previa disponibilità e con sovrapprezzo: www.dieffebi.com/docs/299/2832/DFB_Colour-Chart-2020.pdf
ACCESSORI	<ul style="list-style-type: none"> > Top in vetro laccato bianco RAL 9010 > Chiave Master > Ripiano aggiuntivo in metallo > Appendiabiti > Zoccolo H 40mm > Telaio singolo estraibile e telescopico > Kit 2 telai estraibili e telescopici con guide ad estrazione totale e sistema di estrazione selettiva 35Kg > Kit predisposizione cartelle sospese sotto top > Cartelline sospese per ripiano armadio Lungh. 330mm > Cartelline sospese per telaio armadio Lungh. 390mm > Set 4 piedini H20mm > Set Piedini H 60mm > Kit 4 cerniere con chiusura ammortizzata > Kit 6 cerniere con chiusura ammortizzata > Personalizzabili con ante in legno del cliente
PESO NETTO	45,00 Kg
IMBALLO	<ul style="list-style-type: none"> > Volume: 0,14 m³ > Film plastico in termoretaibile > Angolari e canale in cartone > Ottimizzato per il trasporto con riduzione di CO2 > Fornito: Smontato, > Fornito: Montato con supplemento di prezzo. costo di spedizione non incluso > N°colli: 6
END OF USE	> Corredato di scheda di disassemblaggio per smaltimento.

Primo Cabinets 800

MADE IN ITALY

Armadio anta battente H 1331

L 800 x P 450 x H 1331 mm

DESIGNER Takiro Yuta

BENESSERE E AMBIENTE > Design "green" in accordo con gli standard LEED®, per progettare ed arredare ambienti ad alto contenuto di sostenibilità.



www.GreenTop.com



TEST STRUTTURA TEST:

EN 14073-2:2004, par. 3.4
 EN 14073-3:2004, par. 5.2
 EN 14073-3:2004, par. 5.3.1
 EN 14073-3:2004, par. 5.3.2
 EN 14073-3:2004, par. 5.5
 EN 14074:2004, par. 6.3.1
 EN 14074:2004, par. 6.3.2
 EN 14074:2004, par. 6.3.3
 UNI 8601:1984
 UNI8606:1984

TEST FINITURA

UNI EN ISO 2409:2013
 NSS UNI EN ISO 9227:2017
 UNI EN 15187:2007 EN ISO 1520:2006
 UNI EN ISO 6272-1:2013
 UNI EN 15185:2011
 UNI EN 15186:2012, met.B
 UNI 9300:2015
 EN 12720:2013
 EN 12721:2013
 UNI 9429:2015

CLASSE DI REAZIONE AL FUOCO > Classe O

POSIZIONAMENTO > Sia a muro che in centro stanza



dieffebi



MADE IN EUROPE



ASSUFFICIO
 ASSOCIAZIONE FEDERALE INGEGNERI

ADIMEMBER



consip
 acquistinretepa.it
Il Fornitore Aggiunto della Pubblica Amministrazione

Dieffebi SpA

via Palù 36
 San Vendemiano,
 31020 Treviso - Italia

T +39 0438 4715
 F +39 0438 471600
 exportsales@dieffebi.com
 vendite@dieffebi.com
 www.dieffebi.com

Primo Cabinets 800

Vernici
Lacke
Varnish
Vernis

Corpo
Korpus
Cabinet Body
Caisson



-V1
S711 (RAL 9010)
Pure white



-V6
S380 (RAL 9006)
White aluminium

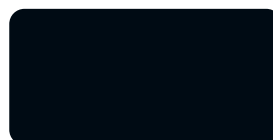

-V22
S811 (RAL 9005)
Jet black

Ripiano aggiuntivo
in metallo
Zusätzlicher
Metallfachboden
Additional metal shelf
Tablette supplémentaire
en métal



-V1
S711 (RAL 9010)
Pure white



-V6
S380 (RAL 9006)
White aluminium



-V22
S811 (RAL 9005)
Jet black

Zoccolo
Sockel
Plinth
Socle

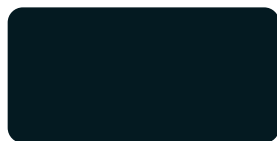

-V19
S210 (RAL 7021)
Black grey

Telaio singolo
Ausziehbarer
Hängemappenrahmen
Single pullout frame
Cadre extractible



-V6
S380 (RAL 9006)
White aluminium

Kit predisposizione cartelle
sospese sotto top
Set Hängemappenrahmen
unter Platte
Kit for hanging files under top
of cabinets
Jeu de rails pour dossier
suspendu sous plateau



-V1
S711 (RAL 9010)
Pure white



-V6
S380 (RAL 9006)
White aluminium

Primo Cabinets 800

Vetro
Glas
Glass
Verre

Top di finitura in vetro
laccato bianco
Glasabdeckplatte weiß
lackiert
White lacquered glass top
Plateau en verre laqué
blanc



-G1
Bianco/White/Blanc/Weiß

Primo Cabinets 800

MADE IN ITALY

Armadio anta battente H 1651
L 800 x P 450 x H 1651 mm

V1	○	bianco	RAL 9010	art.6PRAK806P S711
V6	●	alluminio	RAL 9006	art.6PRAK806P S380
V22	●	nero	RAL 9005	art.6PRAK806P S811

DESIGNER Takiro Yuta

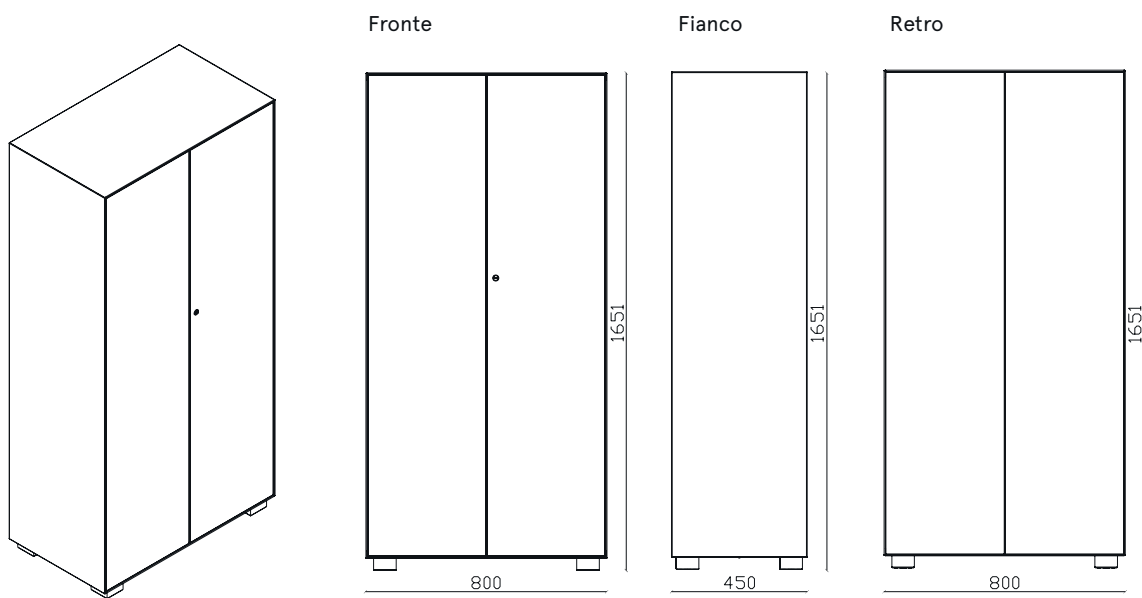

Primo Cabinets 800

MADE IN ITALY

Armadio anta battente H 1651
L800 x P 450 x H 1651 mm

DESIGNER Takiro Yuta

DESCRIZIONE	Armadio Contenitore ante a battente
DIMENSIONI ESTERNE	L 800 mm x P 450 mm x H 1651 mm
DIMENSIONI INTERNE VANO	L 751 mm x P 400 mm x H 1630 mm
DOX	Capienza Dox N°8(x4)
CARTELLINE	Capienza 60(x3) cartelline
PRODUZIONE	<ul style="list-style-type: none"> > Dieffebi S.p.a. > Inizio produzione: anno 2012 > Luogo di produzione: Italia
MANUTENZIONE	<ul style="list-style-type: none"> > Pulire con panno morbido > Non trattare le superfici con panni abrasivi
MATERIALI	> struttura e ante: in metallo riciclato e riciclabile
FINITURA	<ul style="list-style-type: none"> > Verniciatura a polveri basso emissive (materiale inerte) > Esenti da metalli pesanti > Assenza di spigoli vivi e bordi taglienti > Finitura anti riflesso > Non contiene VOC
COMPONENTI STANDARD	<ul style="list-style-type: none"> > Serratura a cilindro con 2 chiavi (fissa +pieghevole) > Disponibile chiave master > Ripiani regolabili: in metallo predisposti per cartelle sospese > N° 3 ripiani inclusi > Portata ripiani: 50 Kg > Piedini regolabili H 40mm > Viti per assemblaggio
GARANZIA	> Dieffebi garantisce che il prodotto è stato realizzato usando materiali di alta qualità - Vedi documento di garanzia.

COLORI	<ul style="list-style-type: none"> > Disponibile in 3 colori standard V1 Bianco (RAL 9010) V6 Alluminio (RAL 9006) V22 Nero (RAL9005) > Colori standard semilucidi > Colori personalizzabili su richiesta previa disponibilità e con sovrapprezzo: www.dieffebi.com/docs/299/2832/DFB_Colour-Chart-2020.pdf
---------------	--

ACCESSORI	<ul style="list-style-type: none"> > Top in vetro laccato bianco RAL 9010 > Chiave Master > Ripiano aggiuntivo in metallo > Appendiabiti > Zoccolo H 40mm > Telaio singolo estraibile e telescopico > Kit 2 telai estraibili e telescopici con guide ad estrazione totale e sistema di estrazione selettiva 35Kg > Kit predisposizione cartelle sospese sotto top > Cartelline sospese per ripiano armadio Lungh. 330mm > Cartelline sospese per telaio armadio Lungh. 390mm > Set 4 piedini H20mm > Set Piedini H 60mm > Kit 4 cerniere con chiusura ammortizzata > Kit 6 cerniere con chiusura ammortizzata > Personalizzabili con ante in legno del cliente
------------------	--

PESO NETTO	54,00 Kg
-------------------	----------

IMBALLO	<ul style="list-style-type: none"> > volume: 0,18 m³ > Film plastico in termoretaibile > Angolari e canale in cartone > Ottimizzato per il trasporto con riduzione di CO2 > Fornito: Smontato, > Fornito: Montato con supplemento di prezzo. costo di spedizione non incluso > N°colli: 7
----------------	--

END OF USE	> Corredato di scheda di disassemblaggio per smaltimento.
-------------------	---

Primo Cabinets 800

MADE IN ITALY

Armadio anta battente H 1651
L 800 x P 450 x H 1651 mm

DESIGNER Takiro Yuta

BENESSERE E AMBIENTE > Design "green" in accordo con gli standard LEED®, per progettare ed arredare ambienti ad alto contenuto di sostenibilità.



www.GreenTop.com



TEST STRUTTURA TEST:

EN 14073-2:2004, par. 3.4
EN 14073-3:2004, par. 5.2
EN 14073-3:2004, par. 5.3.1
EN 14073-3:2004, par. 5.3.2
EN 14073-3:2004, par. 5.5
EN 14074:2004, par. 6.3.1
EN 14074:2004, par. 6.3.2
EN 14074:2004, par. 6.3.3
UNI 8601:1984
UNI 8606:1984

TEST FINITURA

UNI EN ISO 2409:2013
NSS UNI EN ISO 9227:2017
UNI EN 15187:2007 EN ISO 1520:2006
UNI EN ISO 6272-1:2013
UNI EN 15185:2011
UNI EN 15186:2012, met.B
UNI 9300:2015
EN 12720:2013
EN 12721:2013
UNI 9429:2015

CLASSE DI REAZIONE AL FUOCO > Classe 0

POSIZIONAMENTO > Sia a muro che in centro stanza



dieffebi



MADE IN EUROPE



ASSUFFICIO
ASSOCIAZIONE FEDERLEGGIDARREDI

ADIMEMBER



consip
acquistinretepa.it
Il Fornitore Aggiunto della Pubblica Amministrazione

Dieffebi SpA

via Palù 36
San Vendemiano,
31020 Treviso - Italia

T +39 0438 4715
F +39 0438 471600
exportsales@dieffebi.com
vendite@dieffebi.com
www.dieffebi.com

Primo Cabinets 800

Vernici
Varnish
Vernis
Lacke

Corpo
Cabinet Body
Caisson
Korpus

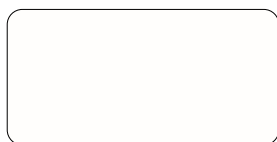

-V1
S711 (RAL 9010)
Pure white



-V6
S380 (RAL 9006)
White aluminium



-V22
S811 (RAL 9005)
Jet black

Ripiano aggiuntivo
in metallo
Additional metal shelf
Tablette supplémentaire
en métal
Zusätzlicher
Metallfachboden

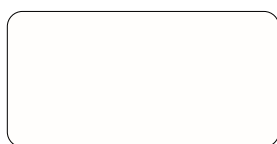

-V1
S711 (RAL 9010)
Pure white



-V6
S380 (RAL 9006)
White aluminium

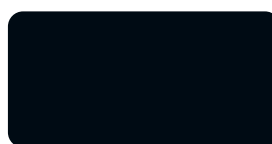

-V22
S811 (RAL 9005)
Jet black

Appendiabiti
Clothes hanger
Tringle
Kleiderstange



-V1
S711 (RAL 9010)
Pure white



-V6
S380 (RAL 9006)
White aluminium

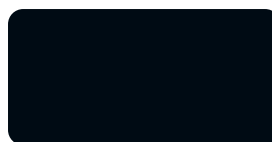

-V22
S811 (RAL 9005)
Jet black

Zoccolo
Plinth
Socle
Sockel

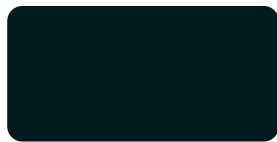

-V19
S210 (RAL 7021)
Black grey

Telaio singolo
Single pullout frame
Cadre extractible
Ausziehbarer
Hängemappenrahmen



-V6
S380 (RAL 9006)
White aluminium

Kit 2 telai estraibili
Set of 2 pullout frames
Jeu de 2 cadres extractibles
Set 2 ausziehbarer
Hängemappenrahmen



-V6
S380 (RAL 9006)
White aluminium

Kit predisposizione cartelle
sospese sotto top
Kit for hanging files under top
of cabinets
Jeu de rails pour dossier
suspendu sous plateau

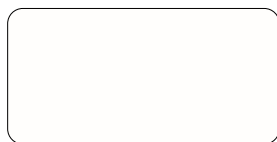

-V1
S711 (RAL 9010)
Pure white



-V6
S380 (RAL 9006)
White aluminium

Primo Cabinets 800

Vetro
Glass
Verre
Glas

Top di finitura in vetro
laccato bianco
White lacquered glass top
Plateau en verre laqué
blanc
Glasabdeckplatte weiß
lackiert

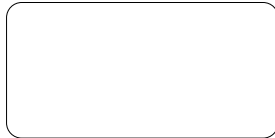

-G1
Bianco/White/Blanc/Weiß

Primo Cabinets 800

MADE IN ITALY

Armadio anta battente H 2003
L 800 x P 450 x H 2003 mm

V1 ○ bianco
V6 ● alluminio
V22 ● nero

RAL 9010

RAL 9006

RAL 9005

art.6PRAK807P S711

art.6PRAK807P S380

art.6PRAK807P S811

DESIGNER Takiro Yuta

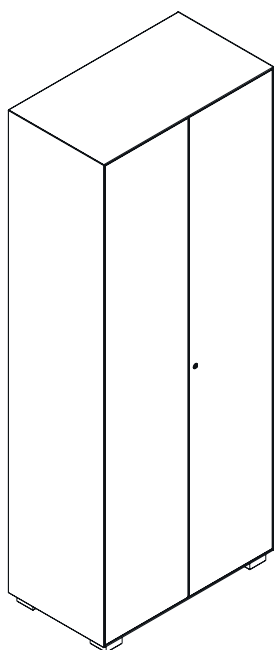

Fronte

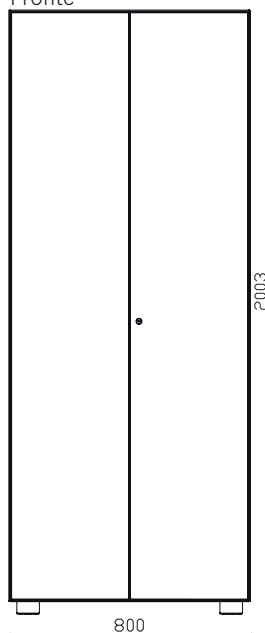

800

Fianco

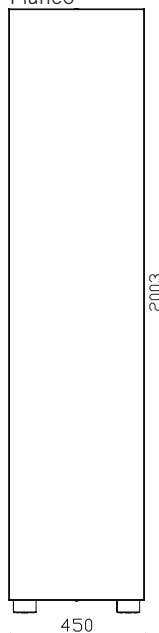

450

Retro

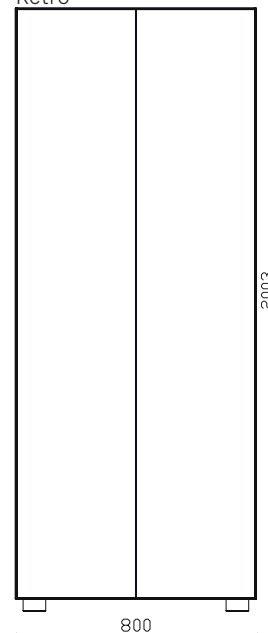

800



Primo Cabinets 800

MADE IN ITALY

Armadio anta battente H 2003
L 800 x P 450 x H 2003 mm

DESIGNER Takiro Yuta

DESCRIZIONE	Armadio Contenitore ante a battente
DIMENSIONI ESTERNE	L 800 mm x P 450 mm x H 2003 mm
DIMENSIONI INTERNE VANO	L 751 mm x P 400 mm x H 1915 mm
DOX	Capacità: 8 (x4)
CARTELLINE	Capacità: 60 (x3) cartelline sospese
PRODUZIONE	<ul style="list-style-type: none"> > Dieffebi S.p.a. > Inizio produzione: anno 2012 > Luogo di produzione: Italia
MANUTENZIONE	<ul style="list-style-type: none"> > Pulire con panno morbido > Non trattare le superfici con panni abrasivi
MATERIALI	> struttura e ante: in metallo riciclato e riciclabile
FINITURA	<ul style="list-style-type: none"> > Verniciatura a polveri basso emissive (materiale inerte) > Esenti da metalli pesanti > Assenza di spigoli vivi e bordi taglienti > Finitura anti riflesso > Non contiene VOC
COMPONENTI STANDARD	<ul style="list-style-type: none"> > Serratura a cilindro con 2 chiavi (fissa +pieghevole) > Disponibile chiave master > Ripiani regolabili: in metallo predisposti per cartelle sospese > N° 3 ripiani inclusi > Portata ripiani: 50 Kg > Piedini regolabili H 40mm > Viti per assemblaggio
GARANZIA	> Dieffebi garantisce che il prodotto è stato realizzato usando materiali di alta qualità - Vedi documento di garanzia.

COLORI	<ul style="list-style-type: none"> > Disponibile in 3 colori standard V1 Bianco (RAL 9010) V6 Alluminio (RAL 9006) V22 Nero (RAL9005) > Colori standard semilucidi > Colori personalizzabili su richiesta previa disponibilità e con sovrapprezzo: www.dieffebi.com/docs/299/2832/DFB_Colour-Chart-2020.pdf
ACCESSORI	<ul style="list-style-type: none"> > Chiave Master > Ripiano aggiuntivo in metallo > Appendiabiti > Zoccolo H 40mm > Telaio singolo estraibile e telescopico > Kit 2 telai estraibili e telescopici con guide ad estrazione totale e sistema di estrazione selettiva 35Kg > Kit predisposizione cartelle sospese sotto top > Cartelline sospese per ripiano armadio Lungh. 330mm > Cartelline sospese per telaio armadio Lungh. 390mm > Set 4 piedini H20mm > Set Piedini H 60mm > Kit 4 cerniere con chiusura ammortizzata > Kit 6 cerniere con chiusura ammortizzata > Personalizzabili con ante in legno del cliente
PESO NETTO	65,00 Kg
IMBALLO	<ul style="list-style-type: none"> > volume: 0,24 m³ > Film plastico in termoretaibile > Angolari e canale in cartone > Ottimizzato per il trasporto con riduzione di CO2 > Fornito: Smontato, > Fornito: Montato con supplemento di prezzo. costo di spedizione non incluso > N° colli: 7
END OF USE	> Corredato di scheda di disassemblaggio per smaltimento

Primo Cabinets 800

MADE IN ITALY

Armadio anta battente H 2003
L 800 x P 450 x H 2003 mm

DESIGNER Takiro Yuta

BENESSERE E AMBIENTE > Design "green" in accordo con gli standard LEED®, per progettare ed arredare ambienti ad alto contenuto di sostenibilità.



www.GreenTop.com



TEST STRUTTURA TEST:

EN 14073-2:2004, par. 3.4
EN 14073-3:2004, par. 5.2
EN 14073-3:2004, par. 5.3.1
EN 14073-3:2004, par. 5.3.2
EN 14073-3:2004, par. 5.5
EN 14074:2004, par. 6.3.1
EN 14074:2004, par. 6.3.2
EN 14074:2004, par. 6.3.3
UNI 8601:1984
UNI 8606:1984

TEST FINITURA

UNI EN ISO 2409:2013
NSS UNI EN ISO 9227:2017
UNI EN 15187:2007 EN ISO 1520:2006
UNI EN ISO 6272-1:2013
UNI EN 15185:2011
UNI EN 15186:2012, met.B
UNI 9300:2015
EN 12720:2013
EN 12721:2013
UNI 9429:2015

CLASSE DI REAZIONE AL FUOCO > Classe O

POSIZIONAMENTO > Sia a muro che in centro stanza



ADIMEMBER



Dieffebi SpA

via Palù 36
San Vendemiano,
31020 Treviso - Italia

T +39 0438 4715
F +39 0438 471600
exportsales@dieffebi.com
vendite@dieffebi.com
www.dieffebi.com

Primo Cabinets 800

Varnish Vernici Vernis Lacke

Cabinet Body
Corpo
Caisson
Korpus



-V1
S711 (RAL 9010)
Pure white



-V6
S380 (RAL 9006)
White aluminium



-V22
S811 (RAL 9005)
Jet black

Additional metal shelf
Ripiano aggiuntivo
in metallo
Tablette supplémentaire
en métal
Zusätzlicher
Metallfachboden



-V1
S711 (RAL 9010)
Pure white



-V6
S380 (RAL 9006)
White aluminium

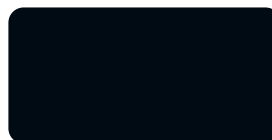

-V22
S811 (RAL 9005)
Jet black

Plinth
Zoccolo
Socle
Sockel

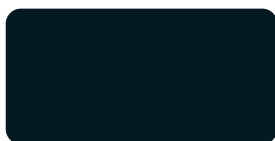

-V19
S210 (RAL 7021)
Black grey

Single pullout frame
Telaio singolo
Cadre extractible
Ausziehbarer
Hängemappenrahmen



-V6
S380 (RAL 9006)
White aluminium

Kit for hanging files under top
of cabinets
Kit predisposizione cartelle
sospese sotto top
Jeu de rails pour dossier
suspendu sous plateau
Set Hängemappenrahmen
unter Platte

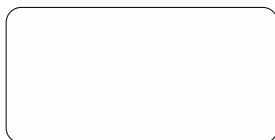

-V1
S711 (RAL 9010)
Pure white



-V6
S380 (RAL 9006)
White aluminium

Primo Cabinets 1000

MADE IN ITALY

Armadio anta battente H 723
L1000 x P 450 x H 723 mm

V1	○	bianco	RAL 9010	art.6PRAK001P S711
V6	●	alluminio	RAL 9006	art.6PRAK001P S380
V22	●	nero	RAL 9005	art.6PRAK001P S811

DESIGNER Takiro Yuta

Fronte

Fianco

Retro

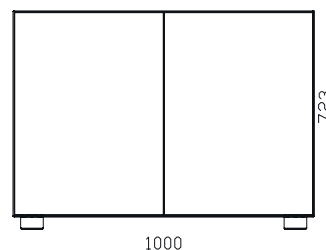
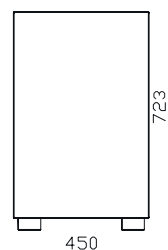
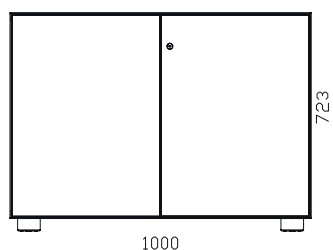
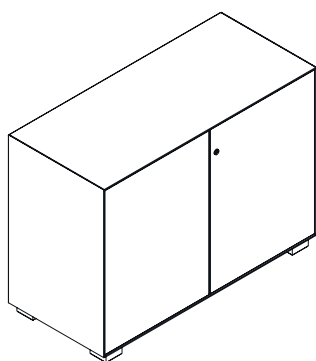

Primo Cabinets 1000

MADE IN ITALY

Armadio anta battente H 723
L1000 x P 450 x H 723 mm

DESIGNER Takiro Yuta

DESCRIZIONE	Armadio Contenitore ante a battente
DIMENSIONI ESTERNE	L 1000 mm x P 450 mm x H 723 mm
DIMENSIONI INTERNE VANO	L 951 mm x P 400 mm x H 635 mm
DOX	Capienza Dox N°11
CARTELLINE	Capienza 76 cartelline
PRODUZIONE	<ul style="list-style-type: none"> > Dieffebi S.p.a. > Inizio produzione: anno 2012 > Luogo di produzione: Italia
MANUTENZIONE	<ul style="list-style-type: none"> > Pulire con panno morbido > Non trattare le superfici con panni abrasivi
MATERIALI	> struttura e ante: in metallo riciclato e riciclabile
FINITURA	<ul style="list-style-type: none"> > Verniciatura a polveri basso emissive (materiale inerte) > Esenti da metalli pesanti > Assenza di spigoli vivi e bordi taglienti > Finitura anti riflesso > Non contiene VOC
COMPONENTI STANDARD	<ul style="list-style-type: none"> > Serratura a cilindro con 2 chiavi (fissa +pieghevole). > Cilindro Non estraibile > Disponibile chiave master > Ripiani regolabili: in metallo predisposti per cartelle sospese > N° 1 ripiano incluso > Portata ripiani: 50 Kg > Piedini regolabili H 40mm > Viti per assemblaggio

COLORI	<ul style="list-style-type: none"> > Disponibile in 3 colori standard V1 Bianco (RAL 9010) V6 Alluminio (RAL 9006) V22 Nero (RAL9005) > Colori standard semilucidi > Colori personalizzabili su richiesta previa disponibilità e con sovrapprezzo: www.dieffebi.com/docs/299/2832/DFB_Colour-Chart-2020.pdf
ACCESSORI	<ul style="list-style-type: none"> > Top in vetro laccato bianco RAL 9010 > Chiave Master > Ripiano aggiuntivo in metallo > Zoccolo H 40mm > Telaio singolo estraibile e telescopico > Kit predisposizione cartelle sospese sotto top > Cartelline sospese per ripiano armadio Lungh. 330mm > Cartelline sospese per telaio armadio Lungh. 390mm > Set 4 piedini H20mm > Set Piedini H 60mm > Kit 4 cerniere con chiusura ammortizzata > Personalizzabili con ante in legno del cliente
PESO NETTO	33,70 Kg
IMBALLO	<ul style="list-style-type: none"> > volume: 0,11 m³ > Film plastico in termoretaibile > Angolari e canale in cartone > Ottimizzato per il trasporto con riduzione di CO2 > Fornito: Smontato, > Fornito: Montato con supplemento di prezzo. costo di spedizione non incluso > N°colli: 6
END OF USE	> Corredato di scheda di disassemblaggio per smaltimento.
GARANZIA	<ul style="list-style-type: none"> > Dieffebi garantisce che il prodotto è stato realizzato usando materiali di alta qualità - Vedi documento di garanzia.

Primo Cabinets 1000

MADE IN ITALY

Armadio anta battente H 723
L 1000 x P 450 x H 723 mm

DESIGNER Takiro Yuta

BENESSERE E AMBIENTE > Design "green" in accordo con gli standard LEED®, per progettare ed arredare ambienti ad alto contenuto di sostenibilità.



www.GreenTop.com



TEST STRUTTURA > EN 14073-2:2004, par. 3.4
> EN 14073-3:2004, par. 5.2
> EN 14073-3:2004, par. 5.3.1
> EN 14073-3:2004, par. 5.3.2
> EN 14073-3:2004, par. 5.5
> EN 14074:2004, par. 6.3.1
> EN 14074:2004, par. 6.3.2
> EN 14074:2004, par. 6.3.3
> UNI 8601:1984
> UNI 8606:1984

TEST FINITURA > UNI EN ISO 2409:2013 > EN ISO 1520:2006
> NSS UNI EN ISO 9227:2017 > UNI 9300:2015
> UNI EN 15187:2007 > UNI EN ISO 6272-1:2013
> EN 12720:2013 > UNI EN 15185:2011
> EN 12721:2013 > UNI EN 15186:2012, met. B
> UNI 9429:2015

CLASSE DI REAZIONE AL FUOCO > Classe 0

POSIZIONAMENTO > Sia a muro che in centro stanza



dieffebi



MADE IN EUROPE



ASSUFFICIO
ASSOCIAZIONE FEDERLEGGIDARREDI

ADIMEMBER



consip
acquistinretepa.it
Il Fornitore Aggiuntivo della Pubblica Amministrazione

Primo Cabinets 1000

Vernici
Varnish
Vernis
Lacke

Corpo
Cabinet Body
Caisson
Korpus



-V1
S711 (RAL 9010)
Pure white



-V6
S380 (RAL 9006)
White aluminium

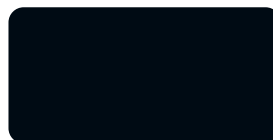

-V22
S811 (RAL 9005)
Jet black

Ripiano aggiuntivo
in metallo
Additional metal shelf
Tablette supplémentaire
en métal
Zusätzlicher
Metallfachboden

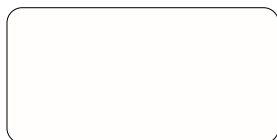

-V1
S711 (RAL 9010)
Pure white



-V6
S380 (RAL 9006)
White aluminium

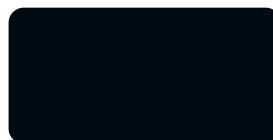

-V22
S811 (RAL 9005)
Jet black

Zoccolo
Plinth
Socle
Sockel

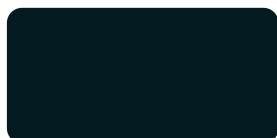

-V19
S210 (RAL 7021)
Black grey

Telaio singolo
Single pullout frame
Cadre extractible
Ausziehbarer
Hängemappenrahmen



-V6
S380 (RAL 9006)
White aluminium

Kit predisposizione cartelle
sospese sotto top
Kit for hanging files under top
of cabinets
Jeu de rails pour dossier
suspendu sous plateau
Set Hängemappenrahmen
unter Platte

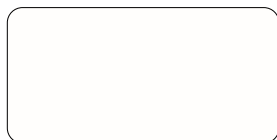

-V1
S711 (RAL 9010)
Pure white



-V6
S380 (RAL 9006)
White aluminium

Primo Cabinets 1000

Vetro
Glass
Verre
Glas

Top di finitura in vetro
laccato bianco
White lacquered glass top
Plateau en verre laqué
blanc
Glasabdeckplatte weiß
lackiert

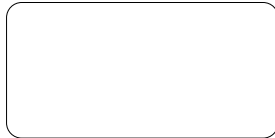

-G1
Bianco/White/Blanc/Weiß

Primo Cabinets 1000

MADE IN ITALY

Armadio anta battente H 743
L1000 x P 450 x H 743 mm

V1	○	bianco	RAL 9010	art.6PRAK001F S711
V6	●	alluminio	RAL 9006	art.6PRAK001F S380
V22	●	nero	RAL 9005	art.6PRAK001F S811

DESIGNER Takiro Yuta

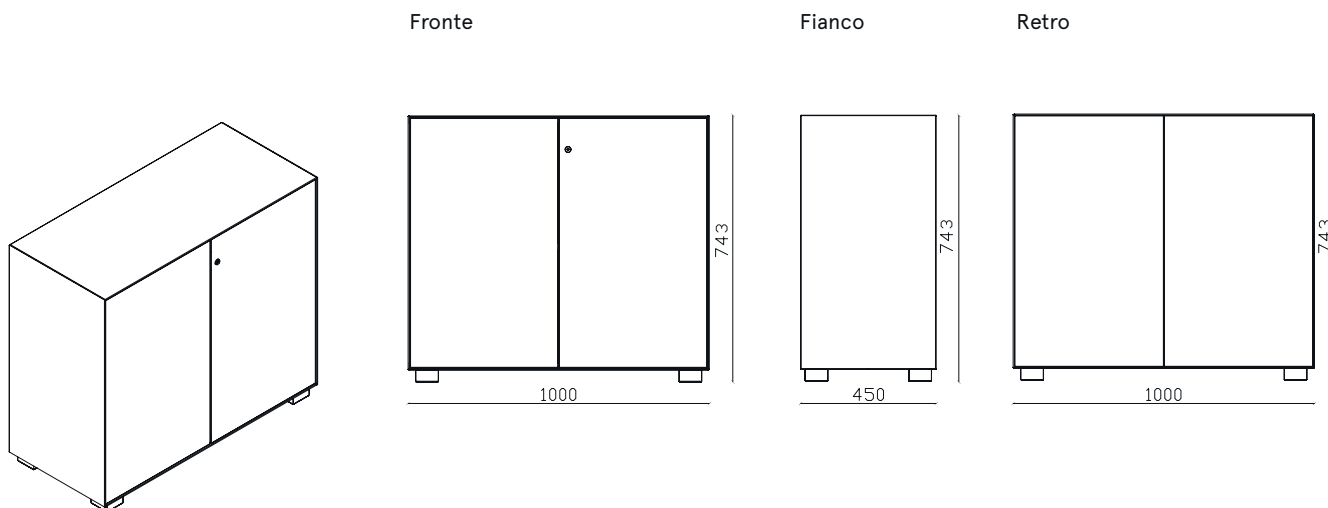

Primo Cabinets 1000

MADE IN ITALY

Armadio anta battente H 743
L1000 x P 450 x H 743 mm

DESIGNER Takiro Yuta

DESCRIZIONE	Armadio Contenitore ante a battente
DIMENSIONI ESTERNE	L 1000 mm x P 450 mm x H 743 mm
DIMENSIONI INTERNE VANO	L 951 mm x P 400 mm x H 635 mm
DOX	Capienza Dox N°11
CARTELLINE	Capienza 76 cartelline
PRODUZIONE	<ul style="list-style-type: none"> > Dieffebi S.p.a. > Inizio produzione: anno 2012 > Luogo di produzione: Italia
MANUTENZIONE	<ul style="list-style-type: none"> > Pulire con panno morbido > Non trattare le superfici con panni abrasivi
MATERIALI	> struttura e ante: in metallo riciclato e riciclabile
FINITURA	<ul style="list-style-type: none"> > Verniciatura a polveri basso emissive (materiale inerte) > Esenti da metalli pesanti > Assenza di spigoli vivi e bordi taglienti > Finitura anti riflesso > Non contiene VOC
COMPONENTI STANDARD	<ul style="list-style-type: none"> > Serratura a cilindro con 2 chiavi (fissa +pieghevole). > Cilindro Non estraibile > Disponibile chiave master > Ripiani regolabili: in metallo predisposti per cartelle sospese > N° 1 ripiano incluso > Portata ripiani: 50 Kg > Piedini regolabili H 40mm > Viti per assemblaggio

COLORI	<ul style="list-style-type: none"> > Disponibile in 3 colori standard V1 Bianco (RAL 9010) V6 Alluminio (RAL 9006) V22 Nero (RAL9005) > Colori standard semilucidi > Colori personalizzabili su richiesta previa disponibilità e con sovrapprezzo: www.dieffebi.com/docs/299/2832/DFB_Colour-Chart-2020.pdf
ACCESSORI	<ul style="list-style-type: none"> > Top in vetro laccato bianco RAL 9010 > Chiave Master > Ripiano aggiuntivo in metallo > Zoccolo H 40mm > Telaio singolo estraibile e telescopico > Kit predisposizione cartelle sospese sotto top > Cartelline sospese per ripiano armadio Lungh. 330mm > Cartelline sospese per telaio armadio Lungh. 390mm > Set 4 piedini H20mm > Set Piedini H 60mm > Kit 4 cerniere con chiusura ammortizzata > Personalizzabili con ante in legno del cliente
PESO NETTO	33,70 Kg
IMBALLO	<ul style="list-style-type: none"> > volume: 0,11 m³ > Film plastico in termoretaibile > Angolari e canale in cartone > Ottimizzato per il trasporto con riduzione di CO2 > Fornito: Smontato, > Fornito: Montato con supplemento di prezzo. costo di spedizione non incluso > N°colli: 6
END OF USE	> Corredato di scheda di disassemblaggio per smaltimento.
GARANZIA	> Dieffebi garantisce che il prodotto è stato realizzato usando materiali di alta qualità - Vedi documento di garanzia.

Primo Cabinets 1000

MADE IN ITALY

Armadio anta battente H 743
L1000 x P 450 x H 743 mm

DESIGNER Takiro Yuta

BENESSERE E AMBIENTE > Design "green" in accordo con gli standard LEED®, per progettare ed arredare ambienti ad alto contenuto di sostenibilità.



www.GreenTop.com



TEST STRUTTURA > EN 14073-2:2004, par. 3.4
> EN 14073-3:2004, par. 5.2
> EN 14073-3:2004, par. 5.3.1
> EN 14073-3:2004, par. 5.3.2
> EN 14073-3:2004, par. 5.5
> EN 14074:2004, par. 6.3.1
> EN 14074:2004, par. 6.3.2
> EN 14074:2004, par. 6.3.3
> UNI 8601:1984
> UNI 8606:1984

TEST FINITURA > UNI EN ISO 2409:2013 > EN ISO 1520:2006
> NSS UNI EN ISO 9227:2017 > UNI 9300:2015
> UNI EN 15187:2007 > UNI EN ISO 6272-1:2013
> EN 12720:2013 > UNI EN 15185:2011
> EN 12721:2013 > UNI EN 15186:2012, met. B
> UNI 9429:2015

CLASSE DI REAZIONE AL FUOCO > Classe 0

POSIZIONAMENTO > Sia a muro che in centro stanza



dieffebi



MADE IN EUROPE



ASSUFFICIO
ASSOCIAZIONE FEDERLEGGIDARREDICI

ADIMEMBER



consip
acquistinretepa.it
Il Fornitore degli Appalti Pubblici per l'edilizia
www.acquistinretepa.it

Primo Cabinets 1000

Vernici
Varnish
Vernis
Lacke

Corpo
Cabinet Body
Caisson
Korpus



-V1
S711 (RAL 9010)
Pure white



-V6
S380 (RAL 9006)
White aluminium



-V22
S811 (RAL 9005)
Jet black

Ripiano aggiuntivo
in metallo
Additional metal shelf
Tablette supplémentaire
en métal
Zusätzlicher
Metallfachboden



-V1
S711 (RAL 9010)
Pure white



-V6
S380 (RAL 9006)
White aluminium



-V22
S811 (RAL 9005)
Jet black

Zoccolo
Plinth
Socle
Sockel

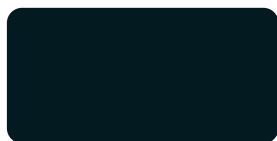

-V19
S210 (RAL 7021)
Black grey

Telaio singolo
Single pullout frame
Cadre extractible
Ausziehbarer
Hängemappenrahmen



-V6
S380 (RAL 9006)
White aluminium

Kit predisposizione cartelle
sospese sotto top
Kit for hanging files under top
of cabinets
Jeu de rails pour dossier
suspendu sous plateau
Set Hängemappenrahmen
unter Platte



-V1
S711 (RAL 9010)
Pure white



-V6
S380 (RAL 9006)
White aluminium

Primo Cabinets 1000

Vetro
Glass
Verre
Glas

Top di finitura in vetro
laccato bianco
White lacquered glass top
Plateau en verre laqué
blanc
Glasabdeckplatte weiß
lackiert

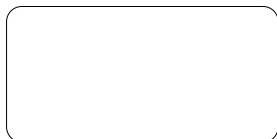

-G1
Bianco/White/Blanc/Weiß

Primo Cabinets 1000

MADE IN ITALY

Armadio anta battente H 883
L1000 x P 450 x H 883 mm

V1	○	bianco	RAL 9010	art.6PRAK002P S711
V6	●	alluminio	RAL 9006	art.6PRAK002P S380
V22	●	nero	RAL 9005	art.6PRAK002P S811

DESIGNER Takiro Yuta

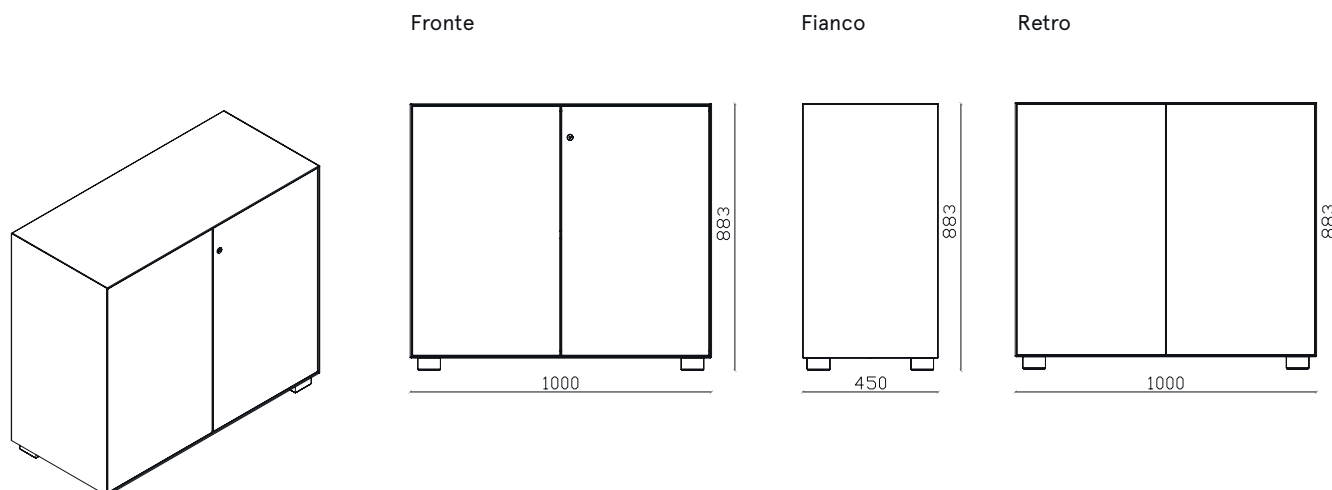

Dieffebi SpA

1 via Palù 36
San Vendemiano,
31020 Treviso - Italia

T +39 0438 4715
F +39 0438 471600
exportsales@dieffebi.com
vendite@dieffebi.com
www.dieffebi.com

22 06 2021

Primo Cabinets 1000

MADE IN ITALY

Armadio anta battente H 883
L1000 x P 450 x H 883 mm

DESIGNER Takiro Yuta

DESCRIZIONE	Armadio Contenitore ante a battente
DIMENSIONI ESTERNE	L 1000 mm x P 450 mm x H 883 mm
DIMENSIONI INTERNE VANO	L 951 mm x P 400 mm x H 795 mm
DOX	Capienza Dox N°11 (x2)
CARTELLINE	Capienza 76 cartelline
PRODUZIONE	<ul style="list-style-type: none"> > Dieffebi S.p.a. > Inizio produzione: anno 2012 > Luogo di produzione: Italia
MANUTENZIONE	<ul style="list-style-type: none"> > Pulire con panno morbido > Non trattare le superfici con panni abrasivi
MATERIALI	> struttura e ante: in metallo riciclato e riciclabile
FINITURA	<ul style="list-style-type: none"> > Verniciatura a polveri basso emissive (materiale inerte) > Esenti da metalli pesanti > Assenza di spigoli vivi e bordi taglienti > Finitura anti riflesso > Non contiene VOC
COMPONENTI STANDARD	<ul style="list-style-type: none"> > Serratura a cilindro con 2 chiavi (fissa +pieghevole). > Cilindro Non estraibile > Disponibile chiave master > Ripiani regolabili: in metallo predisposti per cartelle sospese > N° 1 ripiano incluso > Portata ripiani: 50 Kg > Piedini regolabili H 40mm > Viti per assemblaggio
GARANZIA	Dieffebi garantisce che il prodotto è stato realizzato usando materiali di alta qualità - Vedi documento di garanzia.

COLORI	<ul style="list-style-type: none"> > Disponibile in 3 colori standard V1 Bianco (RAL 9010) V6 Alluminio (RAL 9006) V22 Nero (RAL9005) > Colori standard semilucidi > Colori personalizzabili su richiesta previa disponibilità e con sovrapprezzo: www.dieffebi.com/docs/299/2832/DFB_Colour-Chart-2020.pdf
ACCESSORI	<ul style="list-style-type: none"> > Top in vetro laccato bianco RAL 9010 > Chiave Master > Cilindro per serratura > Ripiano aggiuntivo in metallo > Zoccolo H 40mm > Telaio singolo estraibile e telescopico > Kit 2 telai estraibili e telescopici con guide ad estrazione totale e sistema di estrazione selettiva (35Kg) > Kit predisposizione cartelle sospese sotto top > Cartelline sospese per ripiano armadio Lungh. 330mm > Cartelline sospese per telaio armadio Lungh. 390mm > Set 4 piedini H20mm > Set Piedini H 60mm > Kit 4 cerniere con chiusura ammortizzata > Personalizzabili con ante in legno del cliente
PESO NETTO	39,40 Kg
IMBALLO	<ul style="list-style-type: none"> > volume: 0,12 m³ > Film plastico in termoretaibile > Angolari e canale in cartone > Ottimizzato per il trasporto con riduzione di CO2 > Fornito: Smontato, > Fornito: Montato con supplemento di prezzo. costo di spedizione non incluso > N° colli: 6
END OF USE	> Corredato di scheda di disassemblaggio per smaltimento.

Primo Cabinets 1000

MADE IN ITALY

Armadio anta battente H 883
L1000 x P 450 x H 883 mm

DESIGNER Takiro Yuta

BENESSERE E AMBIENTE > Design "green" in accordo con gli standard LEED®, per progettare ed arredare ambienti ad alto contenuto di sostenibilità.



www.GreenTop.com



TEST STRUTTURA > EN 14073-2:2004, par. 3.4
> EN 14073-3:2004, par. 5.2
> EN 14073-3:2004, par. 5.3.1
> EN 14073-3:2004, par. 5.3.2
> EN 14073-3:2004, par. 5.5
> EN 14074:2004, par. 6.3.1
> EN 14074:2004, par. 6.3.2
> EN 14074:2004, par. 6.3.3
> UNI 8601:1984
> UNI 8606:1984

TEST FINITURA > UNI EN ISO 2409:2013 > EN ISO 1520:2006
> NSS UNI EN ISO 9227:2017 > UNI 9300:2015
> UNI EN 15187:2007 > UNI EN ISO 6272-1:2013
> EN 12720:2013 > UNI EN 15185:2011
> EN 12721:2013 > UNI EN 15186:2012, met. B
> UNI 9429:2015

CLASSE DI REAZIONE AL FUOCO > Classe 0

POSIZIONAMENTO > Sia a muro che in centro stanza



dieffebi



MADE IN EUROPE



ASSUFFICIO
ASSOCIAZIONE FEDERLEGGIDARREDI

ADIMEMBER



consip
acquistinretepa.it
Il Fornitore Aggiunto della Pubblica Amministrazione

Dieffebi SpA

via Palù 36
San Vendemiano,
31020 Treviso - Italia

T +39 0438 4715
F +39 0438 471600
exportsales@dieffebi.com
vendite@dieffebi.com
www.dieffebi.com

Primo Cabinets 1000

Vernici
Varnish
Vernis
Lacke

Corpo
Cabinet Body
Caisson
Korpus



-V1
S711 (RAL 9010)
Pure white



-V6
S380 (RAL 9006)
White aluminium



-V22
S811 (RAL 9005)
Jet black

Ripiano aggiuntivo
in metallo
Additional metal shelf
Tablette supplémentaire
en métal
Zusätzlicher
Metallfachboden

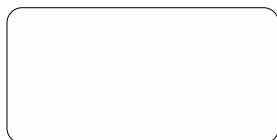

-V1
S711 (RAL 9010)
Pure white



-V6
S380 (RAL 9006)
White aluminium



-V22
S811 (RAL 9005)
Jet black

Zoccolo
Plinth
Socle
Sockel

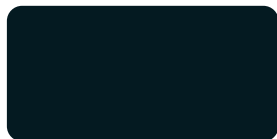

-V19
S210 (RAL 7021)
Black grey

Telaio singolo
Single pullout frame
Cadre extractible
Ausziehbarer
Hängemappenrahmen



-V6
S380 (RAL 9006)
White aluminium

Kit predisposizione cartelle
sospese sotto top
Kit for hanging files under top
of cabinets
Jeu de rails pour dossier
suspendu sous plateau
Set Hängemappenrahmen
unter Platte



-V1
S711 (RAL 9010)
Pure white



-V6
S380 (RAL 9006)
White aluminium

Primo Cabinets 1000

Vetro
Glass
Verre
Glas

Top di finitura in vetro
laccato bianco
White lacquered glass top
Plateau en verre laqué
blanc
Glasabdeckplatte weiß
lackiert

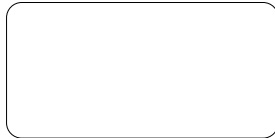

-G1
Bianco/White/Blanc/Weiß

Primo Cabinets 1000

MADE IN ITALY

Armadio anta battente H 1011
L1000 x P 450 x H 1011 mm

V1 ○ bianco
V6 ● alluminio
V22 ● nero

RAL 9010 art.6PRAK003P S711
RAL 9006 art.6PRAK003P S380
RAL 9005 art.6PRAK003P S811

DESIGNER Takiro Yuta

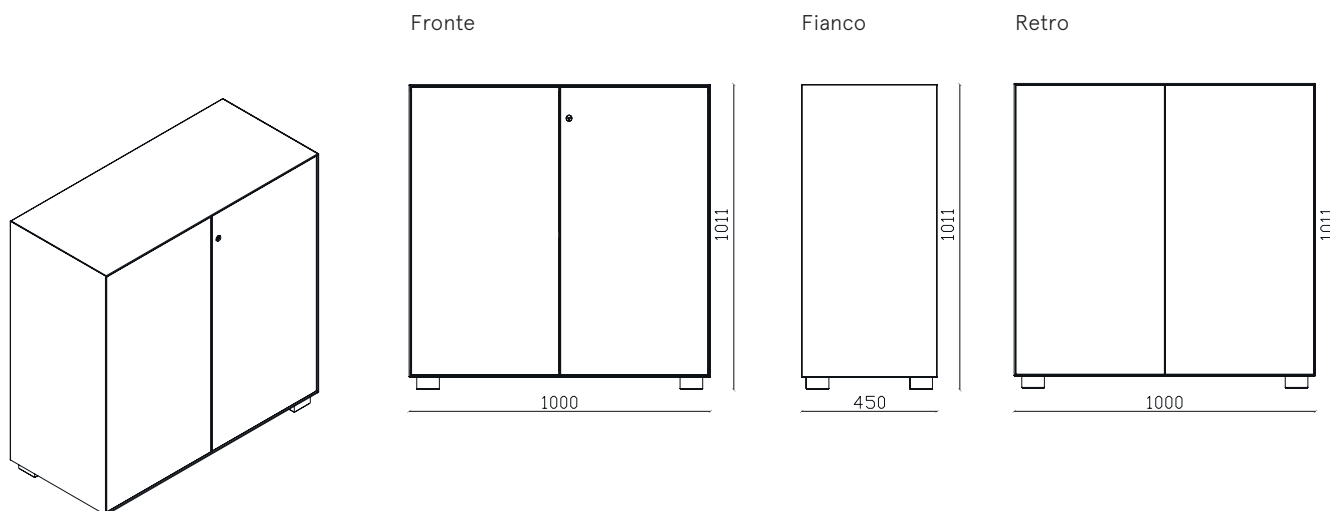

Primo Cabinets 1000

MADE IN ITALY

Armadio anta battente H 1011
L1000 x P 450 x H 1011 mm

DESIGNER Takiro Yuta

DESCRIZIONE	Armoire portes battantes	COLORI	> Disponibile in 3 colori standard V1 Bianco (RAL 9010) V6 Alluminio (RAL 9006) V22 Nero (RAL9005) > Colori standard semilucidi > Colori personalizzabili su richiesta previa disponibilità e con sovrapprezzo: www.dieffebi.com/docs/299/2832/DFB_Colour-Chart-2020.pdf
DIMENSIONI ESTERNE	L 1000 mm x P 450 mm x H 1011 mm	ACCESSORI	> Top in vetro laccato bianco RAL 9010 > Chiave Master > Cilindro per serratura > Ripiano aggiuntivo in metallo > Zoccolo H 40mm > Telaio singolo estraibile e telescopico > Kit 2 telai estraibili e telescopici con guide ad estrazione totale e sistema di estrazione selettiva (35Kg) > Kit predisposizione cartelle sospese sotto top > Cartelline sospese per ripiano armadio Lungh. 330mm > Cartelline sospese per telaio armadio Lungh. 390mm > Set 4 piedini H20mm > Set Piedini H 60mm > Kit 4 cerniere con chiusura ammortizzata > Personalizzabili con ante in legno del cliente
DIMENSIONI INTERNE VANO	L 951 mm x P 400 mm x H 923 mm	PESO NETTO	41,00 Kg
DOX	Capacità: N°11(x2)	IMBALLO	> volume: 0,13 m ³ > Film plastico in termoretaibile > Angolari e canale in cartone > Ottimizzato per il trasporto con riduzione di CO2 > Fornito: Smontato, > Fornito: Montato con supplemento di prezzo. costo di spedizione non incluso > N° colli: 6
CARTELLINE	Capacità: 76 cartelline	END OF USE	> Corredato di scheda di disassemblaggio per smaltimento
PRODUZIONE	> Dieffebi S.p.a. > Inizio produzione: anno 2012 > Luogo di produzione: Italia		
MANUTENZIONE	> Pulire con panno morbido..... > Non trattare le superfici con panni abrasivi		
MATERIALI	> struttura e ante: in metallo riciclato e riciclabile		
FINITURA	> Verniciatura a polveri basso emissive (materiale inerte) > Esenti da metalli pesanti > Assenza di spigoli vivi e bordi taglienti > Finitura anti riflesso > Non contiene VOC		
COMPONENTI STANDARD	> Serratura a cilindro con 2 chiavi (fissa +pieghevole). > Cilindro Non estraibile > Disponibile chiave master > Ripiani regolabili: in metallo predisposti per cartelle sospese > N° 1 ripiano incluso > Portata ripiani: 50 Kg > Piedini regolabili H 40mm > Viti per assemblaggio		
GARANZIA	Dieffebi garantisce che il prodotto è stato realizzato usando materiali di alta qualità - Vedi documento di garanzia.		

Primo Cabinets 1000

MADE IN ITALY

Armadio porta battente H 1011
L1000 x P 450 x H 1011 mm

DESIGNER Takiro Yuta

BENESSERE E AMBIENTE > Design "green" in accordo con gli standard LEED®, per progettare ed arredare ambienti ad alto contenuto di sostenibilità.



TEST STRUTTURA > EN 14073-2:2004, par. 3.4
> EN 14073-3:2004, par. 5.2
> EN 14073-3:2004, par. 5.3.1
> EN 14073-3:2004, par. 5.3.2
> EN 14073-3:2004, par. 5.5
> EN 14074:2004, par. 6.3.1
> EN 14074:2004, par. 6.3.2
> EN 14074:2004, par. 6.3.3
> UNI 8601:1984
> UNI8606:1984

TEST FINITURA > UNI EN ISO 2409:2013 > EN ISO 1520:2006
> NSS UNI EN ISO 9227:2017 > UNI 9300:2015
> UNI EN 15187:2007 > UNI EN ISO 6272-1:2013
> EN 12720:2013 > UNI EN 15185:2011
> EN 12721:2013 > UNI EN 15186:2012, met.B
> UNI 9429:2015

CLASSE DI REAZIONE AL FUOCO > Classe 0

POSIZIONAMENTO > Sia a muro che in centro stanza



ADIMEMBER



Primo Cabinets 1000

Vernici Vernis Varnish Lacke

Corpo
Caisson
Cabinet Body
Korpus



-V1
S711 (RAL 9010)
Pure white



-V6
S380 (RAL 9006)
White aluminium



-V22
S811 (RAL 9005)
Jet black

Ripiano aggiuntivo
in metallo
Tablette supplémentaire
en métal
Additional metal shelf
Zusätzlicher
Metallfachboden

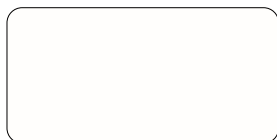

-V1
S711 (RAL 9010)
Pure white



-V6
S380 (RAL 9006)
White aluminium

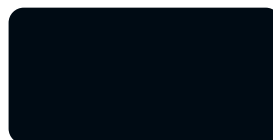

-V22
S811 (RAL 9005)
Jet black

Zoccolo
Socle
Plinth
Sockel

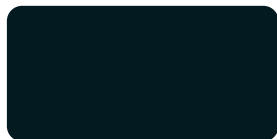

-V19
S210 (RAL 7021)
Black grey

Telaio singolo
Cadre extractible
Single pullout frame
Ausziehbarer
Hängemappenrahmen



-V6
S380 (RAL 9006)
White aluminium

Set of 2 pullout frames
Jeu de 2 cadres extractibles
Kit 2 telai estraibili
Set 2 ausziehbare
Hängemappenrahmen



-V6
S380 (RAL 9006)
White aluminium

Kit predisposizione cartelle
sospese sotto top
Jeu de rails pour dossier
Kit for hanging files under top
of cabinets
suspendu sous plateau

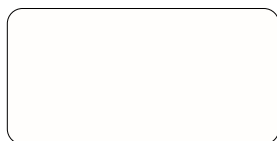

-V1
S711 (RAL 9010)
Pure white



-V6
S380 (RAL 9006)
White aluminium

Primo Cabinets 1000

Vetro
Verre
Glass
Glas

Top di finitura in vetro
laccato bianco
Plateau en verre laqué
blanc
White lacquered glass top
Glasabdeckplatte weiß
lackiert



-G1
Bianco/White/Blanc/Weiß

Primo Cabinets 1000

MADE IN ITALY

Armadio anta battente H 1171
L1000 x P 450 x H 1171 mm

V1	○	bianco	RAL 9010	art.6PRAK004P S711
V6	●	alluminio	RAL 9006	art.6PRAK004P S380
V22	●	nero	RAL 9005	art.6PRAK004P S811

DESIGNER Takiro Yuta

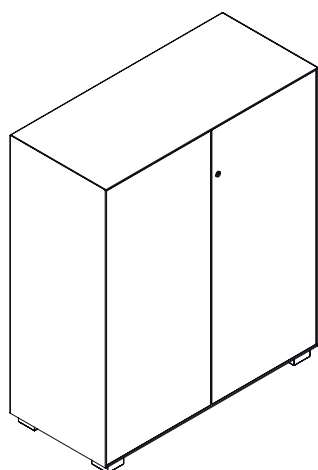

Fronte

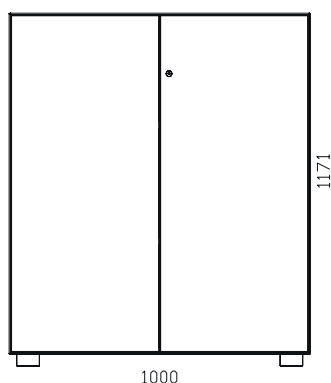

Fianco

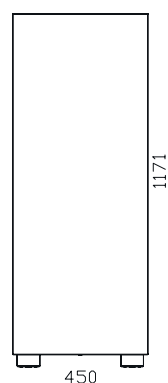

Retro

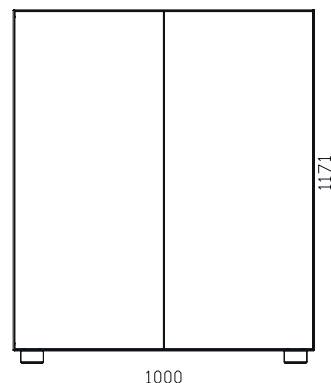

Primo Cabinets 1000

MADE IN ITALY

Armadio anta battente H 1171
L1000 x P 450 x H 1171 mm

DESIGNER Takiro Yuta

DESCRIZIONE	Armadio Contenitore ante a battente
DIMENSIONI ESTERNE	L 1000 mm x P 450 mm x H 1171 mm
DIMENSIONI INTERNE VANO	L 951 mm x P 400 mm x H 1083 mm
DOX	Capienza Dox N°11(x3)
CARTELLINE	Capienza 76 (x2) cartelline
PRODUZIONE	<ul style="list-style-type: none"> > Dieffebi S.p.a. > Inizio produzione: anno 2012 > Luogo di produzione: Italia
MANUTENZIONE	<ul style="list-style-type: none"> > Pulire con panno morbido > Non trattare le superfici con panni abrasivi
MATERIALI	> struttura e ante: in metallo riciclato e riciclabile
FINITURA	<ul style="list-style-type: none"> > Verniciatura a polveri basso emissive (materiale inerte) > Esenti da metalli pesanti > Assenza di spigoli vivi e bordi taglienti > Finitura anti riflesso > Non contiene VOC
COMPONENTI STANDARD	<ul style="list-style-type: none"> > Serratura a cilindro con 2 chiavi (fissa +pieghevole) > Cilindro Non estraibile > Disponibile chiave master > Ripiani regolabili: in metallo predisposti per cartelle sospese > N° 2 ripiani inclusi > Portata ripiani: 50 Kg > Piedini regolabili H 40mm > Viti per assemblaggio
GARANZIA	> Dieffebi garantisce che il prodotto è stato realizzato usando materiali di alta qualità - Vedi documento di garanzia.

COLORI	<ul style="list-style-type: none"> > Disponibile in 3 colori standard V1 Bianco (RAL 9010) V6 Alluminio (RAL 9006) V22 Nero (RAL9005) > Colori standard semilucidi > Colori personalizzabili su richiesta previa disponibilità e con sovrapprezzo: www.dieffebi.com/docs/299/2832/DFB_Colour-Chart-2020.pdf
ACCESSORI	<ul style="list-style-type: none"> > Top in vetro laccato bianco RAL 9010 > Chiave Master > Ripiano aggiuntivo in metallo > Zoccolo H 40mm > Telaio singolo estraibile e telescopico > Kit 2 telai estraibili e telescopici con guide ad estrazione totale e sistema di estrazione selettiva (35 kg) > Kit predisposizione cartelle sospese sotto top > Cartelline sospese per ripiano armadio Lungh. 330mm > Cartelline sospese per telaio armadio Lungh. 390mm > Set 4 piedini H20mm > Set Piedini H 60mm > Kit 4 cerniere con chiusura ammortizzata > Personalizzabili con ante in legno del cliente
PESO NETTO	47,50 Kg
IMBALLO	<ul style="list-style-type: none"> > volume: 0,15 m³ > Film plastico in termoretaibile > Angolari e canale in cartone > Ottimizzato per il trasporto con riduzione di CO2 > Fornito: Smontato, > Fornito: Montato con supplemento di prezzo. costo di spedizione non incluso > N°colli: 6
END OF USE	> Corredato di scheda di disassemblaggio per smaltimento.

Primo Cabinets 1000

MADE IN ITALY

Armadio anta battente H 1171
L1000 x P 450 x H 1171 mm

DESIGNER Takiro Yuta

BENESSERE E AMBIENTE > Design "green" in accordo con gli standard LEED®, per progettare ed arredare ambienti ad alto contenuto di sostenibilità.



www.GreenTop.com



TEST STRUTTURA > EN 14073-2:2004, par. 3.4
> EN 14073-3:2004, par. 5.2
> EN 14073-3:2004, par. 5.3.1
> EN 14073-3:2004, par. 5.3.2
> EN 14073-3:2004, par. 5.5
> EN 14074:2004, par. 6.3.1
> EN 14074:2004, par. 6.3.2
> EN 14074:2004, par. 6.3.3
> UNI 8601:1984
> UNI 8606:1984

TEST FINITURA > UNI EN ISO 2409:2013 > EN ISO 1520:2006
> NSS UNI EN ISO 9227:2017 > UNI 9300:2015
> UNI EN 15187:2007 > UNI EN ISO 6272-1:2013
> EN 12720:2013 > UNI EN 15185:2011
> EN 12721:2013 > UNI EN 15186:2012, met. B
> UNI 9429:2015

CLASSE DI REAZIONE AL FUOCO > Classe 0

POSIZIONAMENTO > Sia a muro che in centro stanza



dieffebi



MADE IN EUROPE



ASSUFFICIO
ASSOCIAZIONE FEDERLEGGIDARREDI

ADIMEMBER



consip
acquistinretepa.it
Il Fornitore Legittimo di tutti i beni Pubblici e Privati

Primo Cabinets 1000

Vernici Varnish Vernis Lacke

Corpo
Cabinet Body
Caisson
Korpus

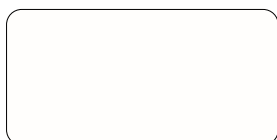

-V1
S711 (RAL 9010)
Pure white



-V6
S380 (RAL 9006)
White aluminium



-V22
S811 (RAL 9005)
Jet black

Ripiano aggiuntivo
in metallo
Additional metal shelf
Tablette supplémentaire
en métal
Zusätzlicher
Metallfachboden

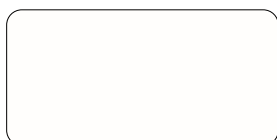

-V1
S711 (RAL 9010)
Pure white



-V6
S380 (RAL 9006)
White aluminium



-V22
S811 (RAL 9005)
Jet black

Zoccolo
Plinth
Socle
Sockel

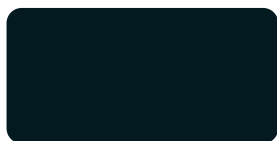

-V19
S210 (RAL 7021)
Black grey

Telaio singolo
Single pullout frame
Cadre extractible
Ausziehbarer
Hängemappenrahmen



-V6
S380 (RAL 9006)
White aluminium

Kit 2 telai estraibili
Set of 2 pullout frames
Jeu de 2 cadres extractibles
Set 2 ausziehbare
Hängemappenrahmen



-V6
S380 (RAL 9006)
White aluminium

Kit predisposizione cartelle
sospese sotto top
Kit for hanging files under top
of cabinets
Jeu de rails pour dossier
suspendu sous plateau

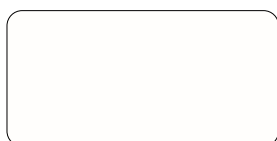

-V1
S711 (RAL 9010)
Pure white



-V6
S380 (RAL 9006)
White aluminium

Primo Cabinets

Vetro
Glass
Verre
Glas

Top di finitura in vetro
laccato bianco
White lacquered glass top
Plateau en verre laqué
blanc
Glasabdeckplatte weiß
lackiert

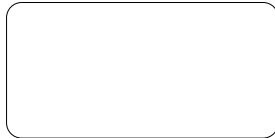

-G1
Bianco/White/Blanc/Weiß

Primo Cabinets 1000

MADE IN ITALY

Armadio anta battente H 1331
L 1000 x P 450 x H 1331 mm

V1 ○ bianco
V6 ● alluminio
V22 ● nero

RAL 9010 art.6PRAK005P S711
RAL 9006 art.6PRAK005P S380
RAL 9005 art.6PRAK005P S811

DESIGNER Takiro Yuta

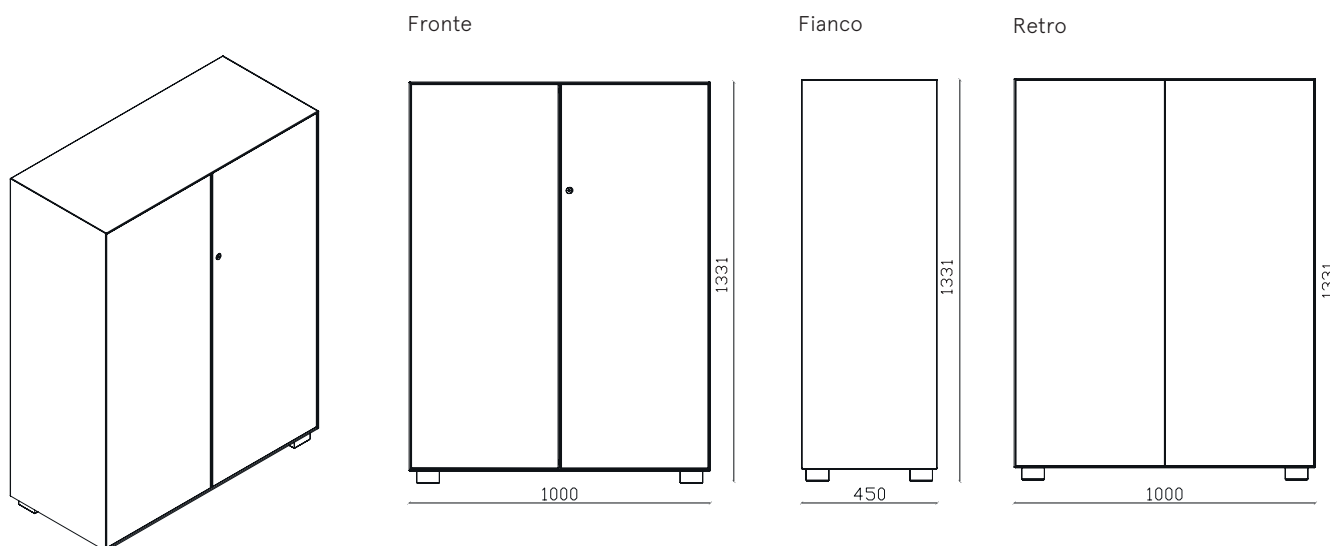

Dieffebi SpA

T +39 0438 4715
F +39 0438 471600
exportsales@dieffebi.com
vendite@dieffebi.com
www.dieffebi.com

Primo Cabinets 1000

MADE IN ITALY

Armadio anta battente H 1331

L 1000 x P 450 x H 1331 mm

DESIGNER Takiro Yuta

DESCRIZIONE Flügeltürschrank

DIMENSIONI L 1000 mm x P 450 mm x H 1331 mm

ESTERNE

DIMENSIONI L 951 mm x P 400 mm x H 1243 mm

INTERNE VANO

DOX Capacità: N°11(x3)

CARTELLINE Capacità: 76 (x2) cartelline sospese

PRODUZIONE > Dieffebi S.p.a.
> Inizio produzione: anno 2012
> Luogo di produzione: Italia

MANUTENZIONE > Pulire con panno morbido
> Non trattare le superfici con panni abrasivi

MATERIALI > struttura e ante: in metallo riciclato e riciclabile

FINITURA > Verniciatura a polveri basso emissive (materiale inerte)
> Esenti da metalli pesanti
> Assenza di spigoli vivi e bordi taglienti
> Finitura anti riflesso
> Non contiene VOC

COMPONENTI STANDARD > Serratura a cilindro con 2 chiavi (fissa +pieghevole)
> Cilindro Non estraibile
> Disponibile chiave master
> Ripiani regolabili: in metallo predisposti per cartelle sospese
> N° 2 ripiani inclusi
> Portata ripiani: 50 Kg
> Piedini regolabili H 40mm
> Viti per assemblaggio

GARANZIA > Dieffebi garantisce che il prodotto è stato realizzato usando materiali di alta qualità - [Vedi documento di garanzia.](#)

COLORI > Disponibile in 3 colori standard
V1 Bianco (RAL 9010)
V6 Alluminio (RAL 9006)
V22 Nero (RAL9005)
> Colori standard semilucidi
> Colori personalizzabili su richiesta previa disponibilità e con sovrapprezzo:
www.dieffebi.com/docs/299/2832/DFB_Colour-Chart-2020.pdf

ACCESSORI > Top in vetro laccato bianco RAL 9010
> Chiave Master
> Ripiano aggiuntivo in metallo
> Zoccolo H 40mm
> Telaio singolo estraibile e telescopico
> Kit 2 telai estraibili e telescopici con guide ad estrazione totale e sistema di estrazione selettiva (35 kg)
> Kit predisposizione cartelle sospese sotto top
> Cartelline sospese per ripiano armadio Lungh. 330mm
> Cartelline sospese per telaio armadio Lungh. 390mm
> Set 4 piedini H20mm
> Set Piedini H 60mm
> Kit 4 cerniere con chiusura ammortizzata
> Personalizzabili con ante in legno del cliente

PESO NETTO 51,00 Kg

IMBALLO > volume: 0,17 m³
> Film plastico in termoretaibile
> Angolari e canale in cartone
> Ottimizzato per il trasporto con riduzione di CO2
> Fornito: Smontato,
> Fornito: Montato con supplemento di prezzo. costo di spedizione non incluso
> N°colli: 6

END OF USE > Corredato di scheda di disassemblaggio per smaltimento

Primo Cabinets 1000

MADE IN ITALY

Armadio anta battente H 1331

L 1000 x P 450 x H 1331 mm

DESIGNER Takiro Yuta

BENESSERE E AMBIENTE > Design "green" in accordo con gli standard LEED®, per progettare ed arredare ambienti ad alto contenuto di sostenibilità.



www.GreenTop.com



TEST STRUTTURA > EN 14073-2:2004, par. 3.4
> EN 14073-3:2004, par. 5.2
> EN 14073-3:2004, par. 5.3.1
> EN 14073-3:2004, par. 5.3.2
> EN 14073-3:2004, par. 5.5
> EN 14074:2004, par. 6.3.1
> EN 14074:2004, par. 6.3.2
> EN 14074:2004, par. 6.3.3
> UNI 8601:1984
> UNI8606:1984

TEST FINITURA > UNI EN ISO 2409:2013 > EN ISO 1520:2006
> NSS UNI EN ISO 9227:2017 > UNI 9300:2015
> UNI EN 15187:2007 > UNI EN ISO 6272-1:2013
> EN 12720:2013 > UNI EN 15185:2011
> EN 12721:2013 > UNI EN 15186:2012, met. B
> UNI 9429:2015

CLASSE DI REAZIONE AL FUOCO > Classe 0

POSIZIONAMENTO > Sia a muro che in centro stanza



ADIMEMBER



Dieffebi SpA

via Palù 36
San Vendemiano,
31020 Treviso - Italia

T +39 0438 4715
F +39 0438 471600
exportsales@dieffebi.com
vendite@dieffebi.com
www.dieffebi.com

Primo Cabinets 1000

Vernici
Varnish
Vernis
Lacke

Corpo
Cabinet Body
Caisson
Korpus



-V1
S711 (RAL 9010)
Pure white



-V6
S380 (RAL 9006)
White aluminium

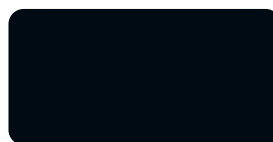

-V22
S811 (RAL 9005)
Jet black

Ripiano aggiuntivo
in metallo
Additional metal shelf
Tablette supplémentaire
en métal
Zusätzlicher
Metallfachboden

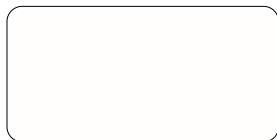

-V1
S711 (RAL 9010)
Pure white



-V6
S380 (RAL 9006)
White aluminium

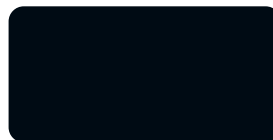

-V22
S811 (RAL 9005)
Jet black

Zoccolo
Plinth
Socle
Sockel

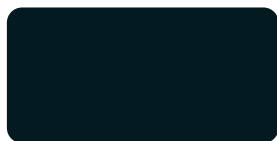

-V19
S210 (RAL 7021)
Black grey

Telaio singolo
Single pullout frame
Cadre extractible
Ausziehbarer
Hängemappenrahmen



-V6
S380 (RAL 9006)
White aluminium

Kit 2 telai estraibili
Set of 2 pullout frames
Jeu de 2 cadres extractibles
Set 2 ausziehbare
Hängemappenrahmen



-V6
S380 (RAL 9006)
White aluminium

Kit predisposizione cartelle
sospese sotto top
Kit for hanging files under top
of cabinets
Jeu de rails pour dossier
suspendu sous plateau



-V1
S711 (RAL 9010)
Pure white



-V6
S380 (RAL 9006)
White aluminium

Primo Cabinets 1000

Vetro
Glass
Verre
Glas

Top di finitura in vetro
laccato bianco
White lacquered glass top
Plateau en verre laqué
blanc
Glasabdeckplatte weiß
lackiert

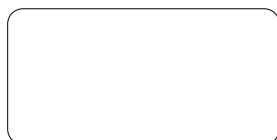

-G1
Bianco/White/Blanc/Weiß

Primo Cabinets 1000

MADE IN ITALY

Armadio anta battente H 1651
L1000 x P 450 x H 1651 mm

V1	○	bianco	RAL 9010	art.6PRAK006P S711
V6	●	alluminio	RAL 9006	art.6PRAK006P S380
V22	●	nero	RAL 9005	art.6PRAK006P S811

DESIGNER Takiro Yuta

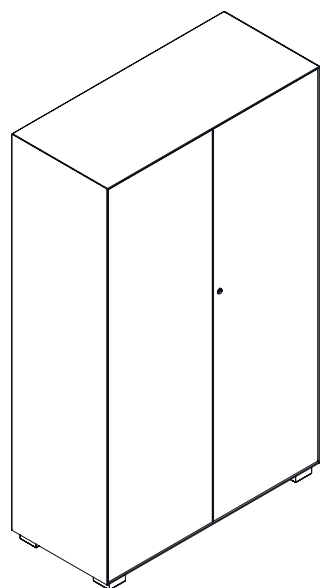

Fronte

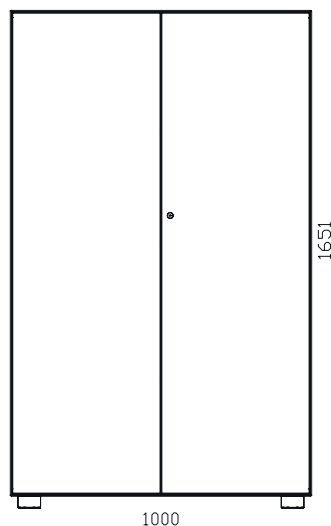

Fianco

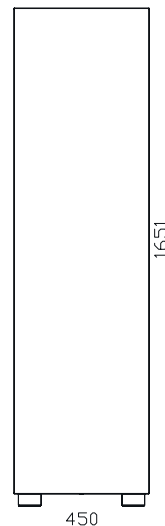

Retro

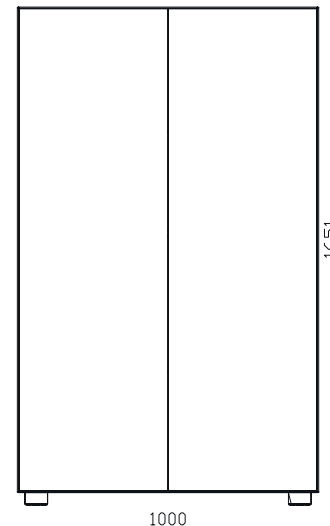

Primo Cabinets 1000

MADE IN ITALY

Armadio anta battente H 1651
L1000 x P 450 x H 1651 mm

DESIGNER Takiro Yuta

DESCRIZIONE	Armadio Contenitore ante a battente
DIMENSIONI ESTERNE	L 1000 mm x P 450 mm x H 1651 mm
DIMENSIONI INTERNE VANO	L 951 mm x P 400 mm x H 1563 mm
DOX	Capienza Dox N°11(x4)
CARTELLINE	Capienza 76 (x3) cartelline
PRODUZIONE	<ul style="list-style-type: none"> > Dieffebi S.p.a. > Inizio produzione: anno 2012 > Luogo di produzione: Italia
MANUTENZIONE	<ul style="list-style-type: none"> > Pulire con panno morbido > Non trattare le superfici con panni abrasivi
MATERIALI	> struttura e ante: in metallo riciclato e riciclabile
FINITURA	<ul style="list-style-type: none"> > Verniciatura a polveri basso emissive (materiale inerte) > Esenti da metalli pesanti > Assenza di spigoli vivi e bordi taglienti > Finitura anti riflesso > Non contiene VOC
COMPONENTI STANDARD	<ul style="list-style-type: none"> > Serratura a cilindro con 2 chiavi (fissa +pieghevole). > Cilindro Non estraibile > Disponibile chiave master > Ripiani regolabili: in metallo predisposti per cartelle sospese > N° 3 ripiani inclusi > Portata ripiani. 50 Kg > Piedini regolabili H 40mm > Viti per assemblaggio
GARANZIA	> Dieffebi garantisce che il prodotto è stato realizzato usando materiali di alta qualità - Vedi documento di garanzia.

COLORI	<ul style="list-style-type: none"> > Disponibile in 3 colori standard V1 Bianco (RAL 9010) V6 Alluminio (RAL 9006) V22 Nero (RAL9005) > Colori standard semilucidi > Colori personalizzabili su richiesta previa disponibilità e con sovrapprezzo: www.dieffebi.com/docs/299/2832/DFB_Colour-Chart-2020.pdf
ACCESSORI	<ul style="list-style-type: none"> > Top in vetro laccato bianco RAL 9010 > Chiave Master > Ripiano aggiuntivo in metallo > Zoccolo H 40mm > Telaio singolo estraibile e telescopico > Kit 2 telai estraibili e telescopici con guide ad estrazione totale e sistema di estrazione selettiva (35 kg) > Kit predisposizione cartelle sospese sotto top > Cartelline sospese per ripiano armadio Lungh. 330mm > Cartelline sospese per telaio armadio Lungh. 390mm > Set 4 piedini H20mm > Set Piedini H 60mm > Kit 4 cerniere con chiusura ammortizzata > Kit 6 cerniere con chiusura ammortizzata > Personalizzabili con ante in legno del cliente
PESO NETTO	62,00 Kg
IMBALLO	<ul style="list-style-type: none"> > volume: 0,21 m³ > Film plastico in termoretaibile > Angolari e canale in cartone > Ottimizzato per il trasporto con riduzione di CO2 > Fornito: Smontato, > Fornito: Montato con supplemento di prezzo. costo di spedizione non incluso > N° colli: 7
END OF USE	> Corredato di scheda di disassemblaggio per smaltimento.

Primo Cabinets 1000

MADE IN ITALY

Armadio anta battente H 1651
L1000 x P 450 x H 1651 mm

DESIGNER Takiro Yuta

BENESSERE E AMBIENTE > Design "green" in accordo con gli standard LEED®, per progettare ed arredare ambienti ad alto contenuto di sostenibilità.



www.GreenTop.com



TEST STRUTTURA > EN 14073-2:2004, par. 3.4
> EN 14073-3:2004, par. 5.2
> EN 14073-3:2004, par. 5.3.1
> EN 14073-3:2004, par. 5.3.2
> EN 14073-3:2004, par. 5.5
> EN 14074:2004, par. 6.3.1
> EN 14074:2004, par. 6.3.2
> EN 14074:2004, par. 6.3.3
> UNI 8601:1984
> UNI8606:1984

TEST FINITURA > UNI EN ISO 2409:2013 > EN ISO 1520:2006
> NSS UNI EN ISO 9227:2017 > UNI 9300:2015
> UNI EN 15187:2007 > UNI EN ISO 6272-1:2013
> EN 12720:2013 > UNI EN 15185:2011
> EN 12721:2013 > UNI EN 15186:2012, met.B
> UNI 9429:2015

CLASSE DI REAZIONE AL FUOCO > Classe 0

POSIZIONAMENTO > Sia a muro che in centro stanza



dieffebi



MADE IN EUROPE



ASSUFFICIO
ASSOCIAZIONE FEDERLEGGIDARREDI

ADIMEMBER



consip
acquistinretepa.it
Il Fornitore degli Appalti Pubblici per l'edilizia
www.acquistinretepa.it

Primo Cabinets 1000

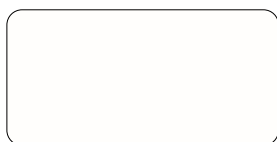
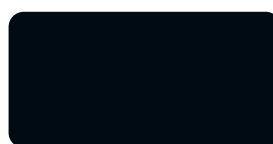
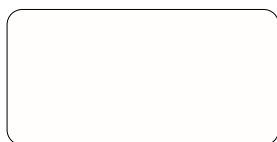
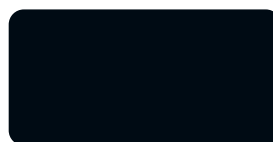
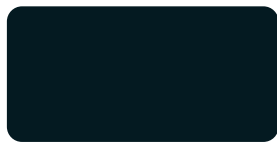
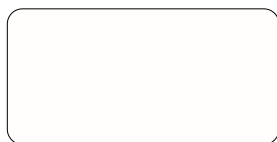
Vernici
Varnish
Vernis
LackeCorpo
Cabinet Body
Caisson
Korpus**-V1**
S711 (RAL 9010)
Pure white**-V6**
S380 (RAL 9006)
White aluminium**-V22**
S811 (RAL 9005)
Jet blackRipiano aggiuntivo
in metallo
Additional metal shelf
Tablette supplémentaire
en métal
Zusätzlicher
Metallfachboden**-V1**
S711 (RAL 9010)
Pure white**-V6**
S380 (RAL 9006)
White aluminium**-V22**
S811 (RAL 9005)
Jet blackAppendiabiti
Clothes hanger
Tringle
Kleiderstange
Metallfachboden**-V1**
S711 (RAL 9010)
Pure white**-V6**
S380 (RAL 9006)
White aluminium**-V22**
S811 (RAL 9005)
Jet blackZoccolo
Plinth
Socle
Sockel**-V19**
S210 (RAL 7021)
Black greyTelaio singolo
Single pullout frame
Cadre extractible
Ausziehbarer
Hängemappenrahmen**-V6**
S380 (RAL 9006)
White aluminiumKit 2 telai estraibili
Set of 2 pullout frames
Jeu de 2 cadres extractibles
Set 2 ausziehbarer
Hängemappenrahmen**-V6**
S380 (RAL 9006)
White aluminiumKit predisposizione cartelle
sospese sotto top
Kit for hanging files under top
of cabinets
Jeu de rails pour dossier
suspendu sous plateau**-V1**
S711 (RAL 9010)
Pure white**-V6**
S380 (RAL 9006)
White aluminium

Primo Cabinets 1000

Vetro
Glass
Verre
Glas

Top di finitura in vetro
laccato bianco
White lacquered glass top
Plateau en verre laqué
blanc
Glasabdeckplatte weiß
lackiert



-G1
Bianco/White/Blanc/Weiß

Primo Cabinets 1000

MADE IN ITALY

Armadio anta battente H 2003
L1000 x P 450 x H 2003 mm

V1	○	bianco	RAL 9010	art.6PRAK007P S711
V6	●	alluminio	RAL 9006	art.6PRAK007P S380
V22	●	nero	RAL 9005	art.6PRAK007P S811

DESIGNER Takiro Yuta

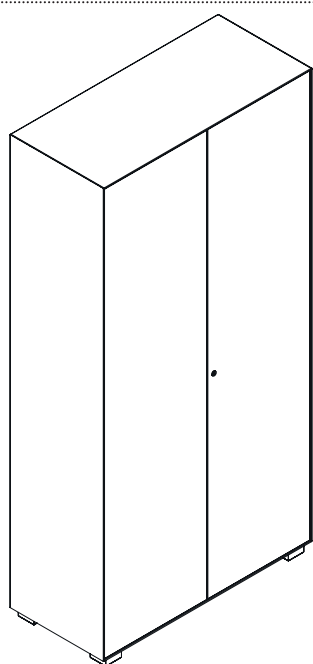

Fronte

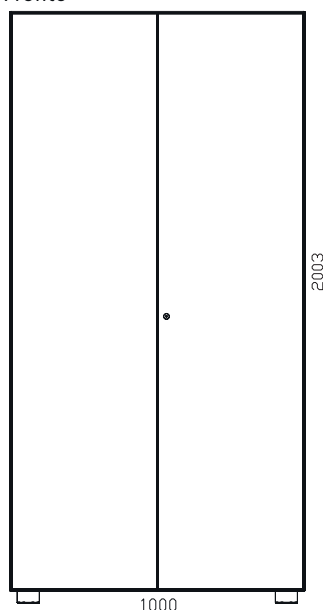

Fianco

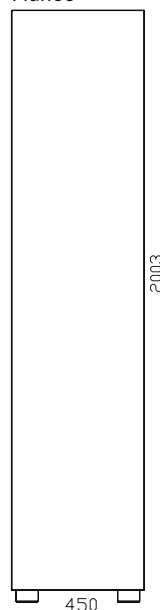

Retro

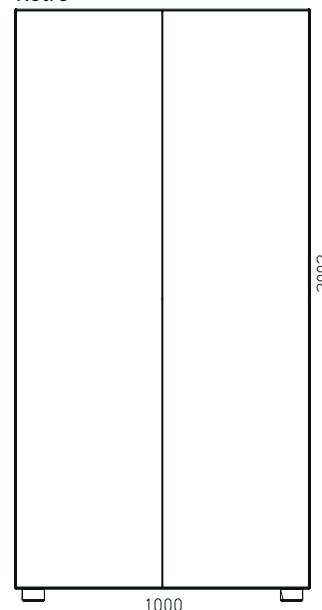

Dieffebi SpA

T +39 0438 4715
F +39 0438 471600
exportsales@dieffebi.com
vendite@dieffebi.com
www.dieffebi.com

Primo Cabinets 1000

MADE IN ITALY

Armadio anta battente H 2003
L1000 x P 450 x H 2003 mm

DESIGNER Takiro Yuta

DESCRIZIONE	Armadio Contenitore ante a battente
DIMENSIONI ESTERNE	L 1000 mm x P 450 mm x H 2003 mm
DIMENSIONI INTERNE VANO	L 951 mm x P 400 mm x H 1915 mm
DOX	Capienza Dox N°11(x5)
CARTELLINE	Capienza 76 (x4) cartelline
PRODUZIONE	<ul style="list-style-type: none"> > Dieffebi S.p.a. > Inizio produzione: anno 2012 > Luogo di produzione: Italia
MANUTENZIONE	<ul style="list-style-type: none"> > Pulire con panno morbido > Non trattare le superfici con panni abrasivi
MATERIALI	> struttura e ante: in metallo riciclato e riciclabile
FINITURA	<ul style="list-style-type: none"> > Verniciatura a polveri basso emissive (materiale inerte) > Esenti da metalli pesanti > Assenza di spigoli vivi e bordi taglienti > Finitura anti riflesso > Non contiene VOC
COMPONENTI STANDARD	<ul style="list-style-type: none"> > Serratura a cilindro con 2 chiavi (fissa +pieghevole). > Cilindro Non estraibile > Disponibile chiave master > Ripiani regolabili: in metallo predisposti per cartelle sospese > N° 4 ripiani inclusi > Portata ripiani. 50 Kg > Piedini regolabili H 40mm > Viti per assemblaggio
GARANZIA	> Dieffebi garantisce che il prodotto è stato realizzato usando materiali di alta qualità - Vedi documento di garanzia.

COLORI	<ul style="list-style-type: none"> > Disponibile in 3 colori standard V1 Bianco (RAL 9010) V6 Alluminio (RAL 9006) V22 Nero (RAL9005) > Colori standard semilucidi > Colori personalizzabili su richiesta previa disponibilità e con sovrapprezzo: www.dieffebi.com/docs/299/2832/DFB_Colour-Chart-2020.pdf
ACCESSORI	<ul style="list-style-type: none"> > Chiave Master > Chiave per estrazione cilindro > Cilindro per serratura > Ripiano aggiuntivo in metallo > Zoccolo H 40mm > Telaio singolo estraibile e telescopico > Kit 2 telai estraibili e telescopici con guide ad estrazione totale e sistema di estrazione selettiva 35 kg) > Kit predisposizione cartelle sospese sotto top > Cartelline sospese per ripiano armadio Lungh. 330mm > Cartelline sospese per telaio armadio Lungh. 390mm > Set 4 piedini H20mm > Set Piedini H 60mm > Kit 4 cerniere con chiusura ammortizzata > Kit 6 cerniere con chiusura ammortizzata > Personalizzabili con ante in legno del cliente
PESO NETTO	73,00 Kg
IMBALLO	<ul style="list-style-type: none"> > volume: 0,28 m³ > Film plastico in termoretaibile > Angolari e canale in cartone > Ottimizzato per il trasporto con riduzione di CO2 > Fornito: Smontato, > Fornito: Montato con supplemento di prezzo. costo di spedizione non incluso > N°colli: 7
END OF USE	> Corredato di scheda di disassemblaggio per smaltimento.

Primo Cabinets 1000

MADE IN ITALY

Armadio anta battente H 2003
L1000 x P 450 x H 2003 mm

DESIGNER Takiro Yuta

BENESSERE E AMBIENTE > Design "green" in accordo con gli standard LEED®, per progettare ed arredare ambienti ad alto contenuto di sostenibilità.



www.GreenTop.com



TEST STRUTTURA > EN 14073-2:2004, par. 3.4
> EN 14073-3:2004, par. 5.2
> EN 14073-3:2004, par. 5.3.1
> EN 14073-3:2004, par. 5.3.2
> EN 14073-3:2004, par. 5.5
> EN 14074:2004, par. 6.3.1
> EN 14074:2004, par. 6.3.2
> EN 14074:2004, par. 6.3.3
> UNI 8601:1984
> UNI 8606:1984

TEST FINITURA > UNI EN ISO 2409:2013 > EN ISO 1520:2006
> NSS UNI EN ISO 9227:2017 > UNI 9300:2015
> UNI EN 15187:2007 > UNI EN ISO 6272-1:2013
> EN 12720:2013 > UNI EN 15185:2011
> EN 12721:2013 > UNI EN 15186:2012, met.B
> UNI 9429:2015

CLASSE DI REAZIONE AL FUOCO > Classe 0

POSIZIONAMENTO > Sia a muro che in centro stanza



dieffebi



MADE IN EUROPE



ASSUFFICIO
ASSOCIAZIONE FIDELIENEGARREDO

ADIMEMBER



consip
acquistinretepa.it
Il Portale degli Appalti della Pubblica Amministrazione

Primo Cabinets 1000

Vernici Varnish Vernis Lacke

Corpo
Cabinet Body
Caisson
Korpus

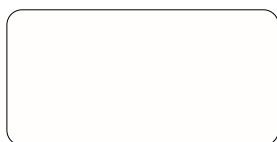

-V1
S711 (RAL 9010)
Pure white



-V6
S380 (RAL 9006)
White aluminium



-V22
S811 (RAL 9005)
Jet black

Ripiano aggiuntivo
in metallo
Additional metal shelf
Tablette supplémentaire
en métal
Zusätzlicher
Metallfachboden

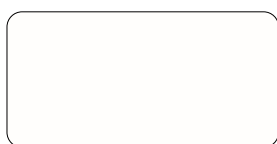

-V1
S711 (RAL 9010)
Pure white



-V6
S380 (RAL 9006)
White aluminium

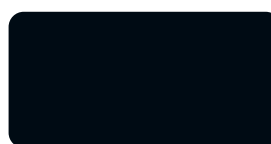

-V22
S811 (RAL 9005)
Jet black

Appendiabiti
Clothes hanger
Tringle
Kleiderstange
Metallfachboden

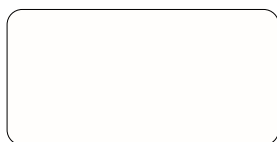

-V1
S711 (RAL 9010)
Pure white



-V6
S380 (RAL 9006)
White aluminium



-V22
S811 (RAL 9005)
Jet black

Zoccolo
Plinth
Socle
Sockel

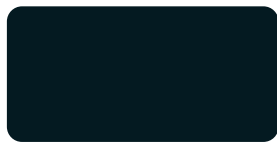

-V19
S210 (RAL 7021)
Black grey

Telaio singolo
Single pullout frame
Cadre extractible
Ausziehbarer
Hängemappenrahmen



-V6
S380 (RAL 9006)
White aluminium

Kit 2 telai estraibili
Set of 2 pullout frames
Jeu de 2 cadres extractibles
Set 2 ausziehbarer
Hängemappenrahmen



-V6
S380 (RAL 9006)
White aluminium

Kit predisposizione cartelle
sospese sotto top
Kit for hanging files under top
of cabinets
Jeu de rails pour dossier
suspendu sous plateau
Set Hängemappenrahmen
unter Platte

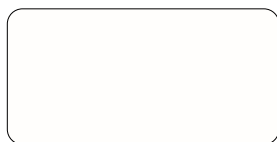

-V1
S711 (RAL 9010)
Pure white



-V6
S380 (RAL 9006)
White aluminium