

Primo Open Cabinets 800

MADE IN ITALY

Offener Schrank

3 altezze dox H 1171

L 800 x P 450 x H 1171 mm

Struttura: metallo

V1 ○ bianco RAL 9010

V6 ● alluminio RAL 9006

V22 ● nero RAL 9005

art.6PRAW804P S711

art.6PRAW804P S380

art.6PRAW804P S811

DESIGNER Takiro Yuta

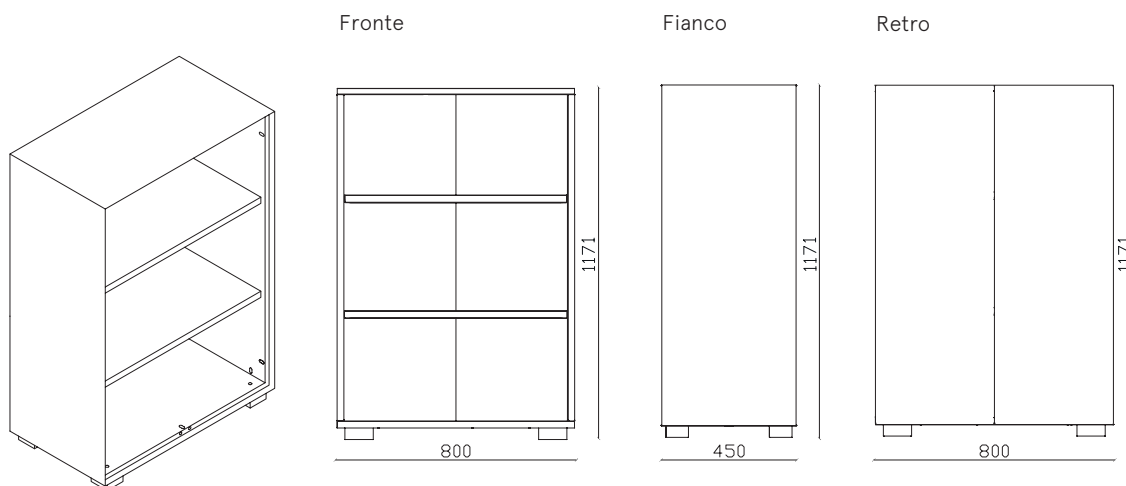

Primo Open Cabinets 800

MADE IN ITALY

Armadio a giorno

3 altezze dox H 1171

L 800 x P 450 x H 1171 mm

DESIGNER Takiro Yuta

DESCRIZIONE Armadio a giorno 3 altezze dox**DIMENSIONI** L 800 mm x P 450 mm x H 1171 mm**ESTERNE****DIMENSIONI** L 751 x P 400 mm x H 1083 mm**INTERNE VANO****DOX** Capienza Dox N° 8 (x3)**CARTELLINE** Capienza 60 (x2) cartelline**PRODUZIONE** > Dieffebi S.p.a.

> Inizio produzione: anno 2018

> Luogo di produzione: Italia

MANUTENZIONE > Pulire con panno morbido

> Non trattare le superfici con panni abrasivi

MATERIALI > struttura in metallo riciclato e riciclabile**FINITURA** > Verniciatura a polveri basso emissive (materiale inerte)

> Esenti da metalli pesanti

> Assenza di spigoli vivi e bordi taglienti

> Finitura anti riflesso

> Non contiene VOC

COMPONENTI STANDARD > Ripiani regolabili: in metallo predisposti per cartelle sospese

> Portata ripiani: 50 Kg

> Piedini regolabili H 40mm

> Viti per assemblaggio

COLORI > Disponibile in 3 colori standard

V1 Bianco (RAL 9010)

V6 Alluminio (RAL 9006)

V22 Nero (RAL9005)

> Colori standard semilucidi

> Colori personalizzabili su richiesta previa

disponibilità e con sovrapprezzo:

www.dieffebi.com/docs/299/2832/DFB_Colour-Chart-2020.pdf**ACCESSORI** > Top di finitura in vetro laccato bianco RAL 9010

> Ripiano aggiuntivo in metallo

> Appendiabiti

> Zoccolo H40mm

> Telaio singolo estraibile e telescopico

> Kit 2 telai estraibili e telescopici con guide ad estrazione totale e sistema di estrazione selettiva (35Kg)

> Kit predisposizione cartelle sospese sotto top

> Cartelline sospese per ripiano armadio Lungh. 330mm

> Cartelline sospese per telaio armadio Lungh. 390mm

> Set 4 piedini H20mm

> Set 4 piedini H 60mm

> possibilità del montaggio porte serie Primo

PESO NETTO 34,00 Kg**IMBALLO** > volume: 0,11 m³

> Film plastico in termoretaibile

> Angolari e canale in cartone

> Ottimizzato per il trasporto con riduzione di CO2

> Fornito: Smontato

> N°colli: 5

END OF USE > Corredato di scheda di disassemblaggio per smaltimento.**GARANZIA** > Dieffebi garantisce che il prodotto è stato realizzato usando materiali di alta qualità - [Vedi documento di garanzia.](#)

Primo Open Cabinets 800

MADE IN ITALY

Armadio a giorno
3 altezze dox H 1171
L 800 x P 450 x H 1171 mm

DESIGNER Takiro Yuta

BENESSERE E AMBIENTE > Design "green" in accordo con gli standard LEED®, per progettare ed arredare ambienti ad alto contenuto di sostenibilità.



www.GreenTop.com



TEST STRUTTURA E FINITURA Test equivalenti alla serie Armadio Primo Cabinets eseguiti dall'ente CATAS.
- dichiarazione di conformità disponibile su richiesta

CLASSE DI REAZIONE AL FUOCO > Classe 0

POSIZIONAMENTO > Sia a muro che in centro stanza



dieffebi



MADE IN EUROPE



ASSUFFICIO
ASSOCIAZIONE FEDERLEGGIDARREDI

ADIMEMBER



consip
acquistinretepa.it
Il Portale degli Appalti della Pubblica Amministrazione

Primo Open Cabinets 800

Vernici
Varnish
Vernis
Lacke

Corpo
Cabinet Body
Caisson
Korpus



-V1
S711 (RAL 9010)
Pure white



-V6
S380 (RAL 9006)
White aluminium



-V22
S811 (RAL 9005)
Jet black

Ripiano aggiuntivo
in metallo
Additional metal shelf
Tablette supplémentaire
en métal
Zusätzlicher
Metallfachboden

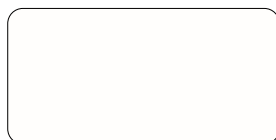

-V1
S711 (RAL 9010)
Pure white



-V6
S380 (RAL 9006)
White aluminium



-V22
S811 (RAL 9005)
Jet black

Appendiabiti
Clothes hanger
Tringle
Kleiderstange



-V1
S711 (RAL 9010)
Pure white



-V6
S380 (RAL 9006)
White aluminium

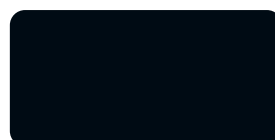

-V22
S811 (RAL 9005)
Jet black

Zoccolo
Plinth
Socle
Sockel

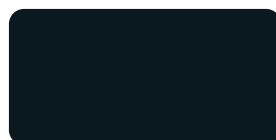

-V1
S210 (RAL 7021)
Black grey

Kit predisposizione cartelle
sospese sotto top
Kit for hanging files under top
of cabinets
Jeu de rails pour dossier
suspendu sous plateau



-V1
S711 (RAL 9010)
Pure white



-V6
S380 (RAL 9006)
White aluminium

Vetro
Glass
Verre
Glas

Top di finitura in vetro
laccato bianco
White lacquered glass top
Plateau en verre laqué
blanc
Glasabdeckplatte weiß
lackiert

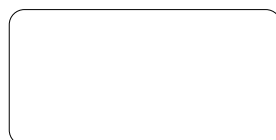

-G1
Bianco/White/Blanc/Weiß

Primo Open Cabinets 800

MADE IN ITALY

Armadio a giorno

3 altezze dox H 1331

L 800 x P 450 x H 1331 mm

Struttura: metallo

V1 ○ bianco RAL 9010

V6 ● alluminio RAL 9006

V22 ● nero RAL 9005

art.6PRAW805P S711

art.6PRAW805P S380

art.6PRAW805P S811

DESIGNER Takiro Yuta

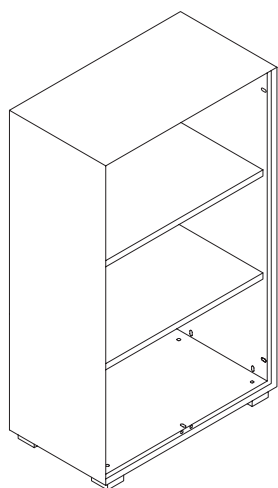

Fronte

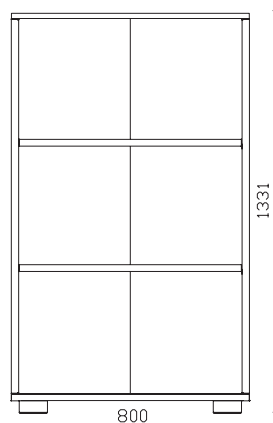

Fianco

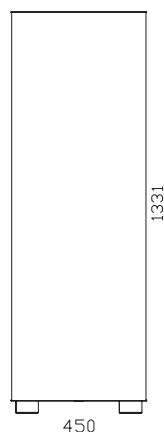

Retro

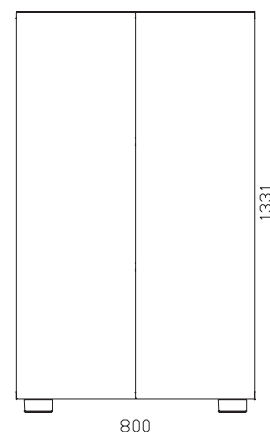

Primo Open Cabinets 800

MADE IN ITALY

Armadio a giorno

3 altezze dox H 1331

L 800 x P 450 x H 1331 mm

DESIGNER Takiro Yuta

DESCRIZIONE Armadio a giorno 3 altezze dox

DIMENSIONI L 800 mm x P 450 mm x H 1331 mm

ESTERNE

DIMENSIONI L 751 x P 400 mm x H 1243 mm

INTERNE VANO

DOX Capienza Dox N° 8 (x3)

CARTELLINE Capienza 60 (x2) cartelline

PRODUZIONE > Dieffebi S.p.a.

> Inizio produzione: anno 2018

> Luogo di produzione: Italia

MANUTENZIONE > Pulire con panno morbido

> Non trattare le superfici con panni abrasivi

MATERIALI > struttura in metallo riciclato e riciclabile

FINITURA > Verniciatura a polveri basso emissive (materiale inerte)

> Esenti da metalli pesanti

> Assenza di spigoli vivi e bordi taglienti

> Finitura anti riflesso

> Non contiene VOC

COMPONENTI STANDARD > Ripiani regolabili: in metallo predisposti per cartelle sospese

> Portata ripiani: 50 Kg

> Piedini regolabili H 40mm

> Viti per assemblaggio

COLORI > Disponibile in 3 colori standard

V1 Bianco (RAL 9010)

V6 Alluminio (RAL 9006)

V22 Nero (RAL9005)

> Colori standard semilucidi

> Colori personalizzabili su richiesta previa

disponibilità e con sovrapprezzo:

www.dieffebi.com/docs/299/2832/DFB_Colour-Chart-2020.pdf

ACCESSORI > Top di finitura in vetro laccato bianco RAL 9010

> Ripiano aggiuntivo in metallo

> Appendiabiti

> Zoccolo H40mm

> Telaio singolo estraibile e telescopico

> Kit 2 telai estraibili e telescopici con guide ad estrazione totale e sistema di estrazione selettiva (35Kg)

> Kit predisposizione cartelle sospese sotto top

> Cartelline sospese per ripiano armadio Lungh. 330mm

> Cartelline sospese per telaio armadio Lungh. 390mm

> Set 4 piedini H20mm

> Set 4 piedini H 60mm

> possibilità del montaggio porte serie Primo

PESO NETTO 36,40 Kg

IMBALLO > volume: 0,12 m³

> Film plastico in termoretaibile

> Angolari e canale in cartone

> Ottimizzato per il trasporto con riduzione di CO2

> Fornito: Smontato

> N°colli: 5

END OF USE > Corredato di scheda di disassemblaggio per smaltimento.

GARANZIA > Dieffebi garantisce che il prodotto è stato realizzato usando materiali di alta qualità - [Vedi documento di garanzia.](#)

Primo Open Cabinets 800

MADE IN ITALY

Armadio a giorno

3 altezze dox H 1331

L 800 x P 450 x H 1331 mm

DESIGNER Takiro Yuta

BENESSERE E AMBIENTE > Design "green" in accordo con gli standard LEED®, per progettare ed arredare ambienti ad alto contenuto di sostenibilità.



www.GreenTop.com



TEST STRUTTURA EN 14073-2:2004, par. 3.4
 EN 14073-3:2004, par. 5.2
 EN 14073-3:2004, par. 5.3.1
 EN 14073-3:2004, par. 5.3.2
 EN 14073-3:2004, par. 5.5
 EN 14074:2004, par. 6.3.1
 EN 14074:2004, par. 6.3.2
 EN 14074:2004, par. 6.3.3
 UNI 8601:1984
 UNI8606:1984

TEST FINITURA UNI EN ISO 2409:2013
 NSS UNI EN ISO 9227:2017
 UNI EN 15187:2007 EN ISO 1520:2006
 UNI EN ISO 6272-1:2013
 UNI EN 15185:2011
 UNI EN 15186:2012, met.B
 UNI 9300:2015
 EN 12720:2013
 EN 12721:2013
 UNI 9429:2015

CLASSE DI > Classe 0

REAZIONE AL FUOCO

POSIZIONAMENTO > Sia a muro che in centro stanza



dieffebi



MADE IN EUROPE



ASSUFFICIO
 ASSOCIAZIONE FEDERLEGGIDARREDI

ADIMEMBER



consip
 acquistinretepa.it
 Il Fondo Saggi al Quarta Gara Publica per l'Arredamento

Primo Open Cabinets 800

Vernici Varnish Vernis Lacke

Corpo
Cabinet Body
Caisson
Korpus



-V1
S711 (RAL 9010)
Pure white



-V6
S380 (RAL 9006)
White aluminium



-V22
S811 (RAL 9005)
Jet black

Ripiano aggiuntivo
in metallo
Additional metal shelf
Tablette supplémentaire
en métal
Zusätzlicher
Metallfachboden

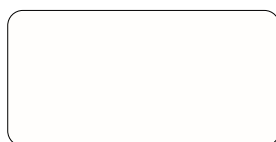

-V1
S711 (RAL 9010)
Pure white



-V6
S380 (RAL 9006)
White aluminium



-V22
S811 (RAL 9005)
Jet black

Appendiabiti
Clothes hanger
Tringle
Kleiderstange



-V1
S711 (RAL 9010)
Pure white



-V6
S380 (RAL 9006)
White aluminium



-V22
S811 (RAL 9005)
Jet black

Zoccolo
Plinth
Socle
Sockel



-V1
S210 (RAL 7021)
Black grey

Kit predisposizione cartelle
sospese sotto top
Kit for hanging files under top
of cabinets
Jeu de rails pour dossier
suspendu sous plateau



-V1
S711 (RAL 9010)
Pure white



-V6
S380 (RAL 9006)
White aluminium

Vetro Glass Verre Glas

Top di finitura in vetro
laccato bianco
White lacquered glass top
Plateau en verre laqué
blanc
Glasabdeckplatte weiß
lackiert



-G1
Bianco/White/Blanc/Weiß

Primo Open Cabinets 800

MADE IN ITALY

Armadio a giorno

4 altezze dox H 1651

L 800 x P 450 x H 1651 mm

Struttura: metallo

V1 ○ bianco RAL 9010

V6 ● alluminio RAL 9006

V22 ● nero RAL 9005

art.6PRAW806P S711

art.6PRAW806P S380

art.6PRAW806P S811

DESIGNER Takiro Yuta

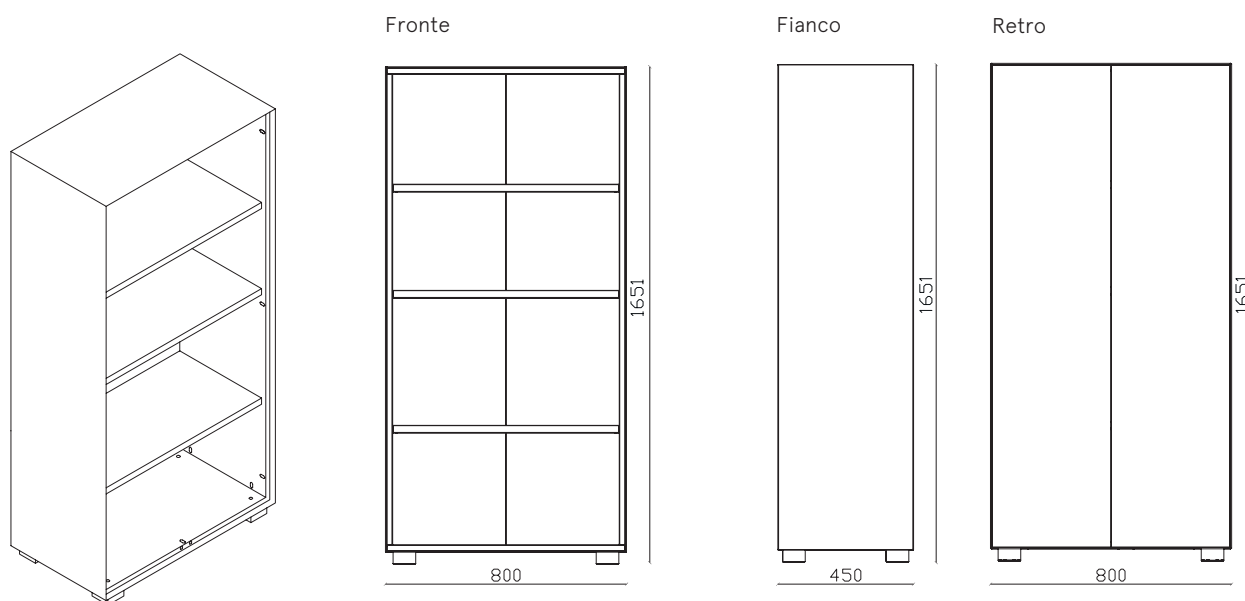

Primo Open Cabinets 800

MADE IN ITALY

Armadio a giorno

4 altezze dox H 1651

L 800 x P 450 x H 1651 mm

DESIGNER Takiro Yuta

DESCRIZIONE Armadio a giorno 4 altezze dox**DIMENSIONI** L 800 mm x P 450 mm x H 1651 mm**ESTERNE****DIMENSIONI** L 751 x P 400 mm x H 1563 mm**INTERNE VANO****DOX** Capienza Dox N° 8 (x4)**CARTELLINE** Capienza 60 (x3) cartelline**PRODUZIONE** > Dieffebi S.p.a.
> Inizio produzione: anno 2018
> Luogo di produzione: Italia**MANUTENZIONE** > Pulire con panno morbido
> Non trattare le superfici con panni abrasivi**MATERIALI** > struttura in metallo riciclato e riciclabile**FINITURA** > Verniciatura a polveri basso emissive (materiale inerte)
> Esenti da metalli pesanti
> Assenza di spigoli vivi e bordi taglienti
> Finitura anti riflesso
> Non contiene VOC**COMPONENTI STANDARD** > Ripiani regolabili: in metallo predisposti per cartelle sospese
> Portata ripiani: 50 Kg
> Piedini regolabili H 40mm
> Viti per assemblaggio**COLORI** > Disponibile in 3 colori standard

V1 Bianco (RAL 9010)

V6 Alluminio (RAL 9006)

V22 Nero (RAL9005)

> Colori standard semilucidi

> Colori personalizzabili su richiesta previa disponibilità e con sovrapprezzo:

www.dieffebi.com/docs/299/2832/DFB_Colour-Chart-2020.pdf**ACCESSORI** > Top di finitura in vetro laccato bianco RAL 9010
> Ripiano aggiuntivo in metallo
> Appendiabiti
> Zoccolo H40mm
> Telaio singolo estraibile e telescopico
> Kit 2 telai estraibili e telescopici con guide ad estrazione totale e sistema di estrazione selettiva (35Kg)
> Kit predisposizione cartelle sospese sotto top
> Cartelline sospese per ripiano armadio Lungh. 330mm
> Cartelline sospese per telaio armadio Lungh. 390mm
> Set 4 piedini H20mm
> Set 4 piedini H 60mm
> possibilità del montaggio porte serie Primo**PESO NETTO** 43,70 Kg**IMBALLO** > volume: 0,14 m³
> Film plastico in termoretaibile
> Angolari e canale in cartone
> Ottimizzato per il trasporto con riduzione di CO2
> Fornito: Smontato
> N°colli: 6**END OF USE** > Corredato di scheda di disassemblaggio per smaltimento.**GARANZIA** > Dieffebi garantisce che il prodotto è stato realizzato usando materiali di alta qualità - [Vedi documento di garanzia.](#)

Primo Open Cabinets 800

MADE IN ITALY

Armadio a giorno

4 altezze dox H 1651

L 800 x P 450 x H 1651 mm

DESIGNER Takiro Yuta

BENESSERE E AMBIENTE > Design "green" in accordo con gli standard LEED®, per progettare ed arredare ambienti ad alto contenuto di sostenibilità.



www.GreenTop.com



TEST STRUTTURA EN 14073-2:2004, par. 3.4
 EN 14073-3:2004, par. 5.2
 EN 14073-3:2004, par. 5.3.1
 EN 14073-3:2004, par. 5.3.2
 EN 14073-3:2004, par. 5.5
 EN 14074:2004, par. 6.3.1
 EN 14074:2004, par. 6.3.2
 EN 14074:2004, par. 6.3.3
 UNI 8601:1984
 UNI8606:1984

TEST FINITURA UNI EN ISO 2409:2013
 NSS UNI EN ISO 9227:2017
 UNI EN 15187:2007 EN ISO 1520:2006
 UNI EN ISO 6272-1:2013
 UNI EN 15185:2011
 UNI EN 15186:2012, met.B
 UNI 9300:2015
 EN 12720:2013
 EN 12721:2013
 UNI 9429:2015

CLASSE DI > Classe 0

REAZIONE AL FUOCO

POSIZIONAMENTO > Sia al muro che in centro stanza



dieffebi



MADE IN EUROPE



ASSUFFICIO
 ASSOCIAZIONE FEDERLEASINGARREDO

ADIMEMBER



consip
 acquistinretepa.it
Il Fornitore Aggiunto della Pubblica Amministrazione

Dieffebi SpA

via Palù 36
 San Vendemiano,
 31020 Treviso - Italia

T +39 0438 4715
 F +39 0438 471600
 exportsales@dieffebi.com
 vendite@dieffebi.com
 www.dieffebi.com

Primo Open Cabinets 800

Vernici
Varnish
Vernis
Lacke

Corpo
Cabinet Body
Caisson
Korpus



-V1
S711 (RAL 9010)
Pure white



-V6
S380 (RAL 9006)
White aluminium



-V22
S811 (RAL 9005)
Jet black

Ripiano aggiuntivo
in metallo
Additional metal shelf
Tablette supplémentaire
en métal
Zusätzlicher
Metallfachboden

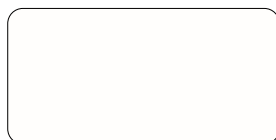

-V1
S711 (RAL 9010)
Pure white



-V6
S380 (RAL 9006)
White aluminium



-V22
S811 (RAL 9005)
Jet black

Appendiabiti
Clothes hanger
Tringle
Kleiderstange



-V1
S711 (RAL 9010)
Pure white



-V6
S380 (RAL 9006)
White aluminium

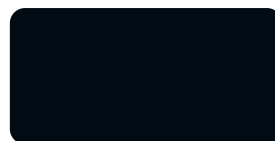

-V22
S811 (RAL 9005)
Jet black

Zoccolo
Plinth
Socle
Sockel



-V1
S210 (RAL 7021)
Black grey

Kit predisposizione cartelle
sospese sotto top
Kit for hanging files under top
of cabinets
Jeu de rails pour dossier
suspendu sous plateau



-V1
S711 (RAL 9010)
Pure white



-V6
S380 (RAL 9006)
White aluminium

Vetro
Glass
Verre
Glas

Top di finitura in vetro
laccato bianco
White lacquered glass top
Plateau en verre laqué
blanc
Glasabdeckplatte weiß
lackiert



-G1
Bianco/White/Blanc/Weiß

Primo Open Cabinets 800

MADE IN ITALY

Armadio a giorno

5 altezze dox H 2003

L 800 x P 450 x H 2003 mm

Struttura: metallo

V1 ○ bianco RAL 9010

art.6PRAW807P S711

V6 ● alluminio RAL 9006

art.6PRAW807P S380

V22 ● nero RAL 9005

art.6PRAW807P S811

DESIGNER Takiro Yuta

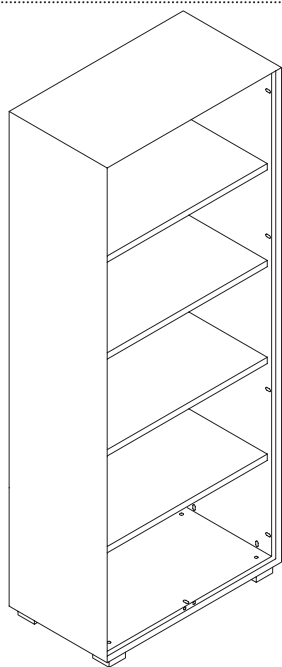

Fronte

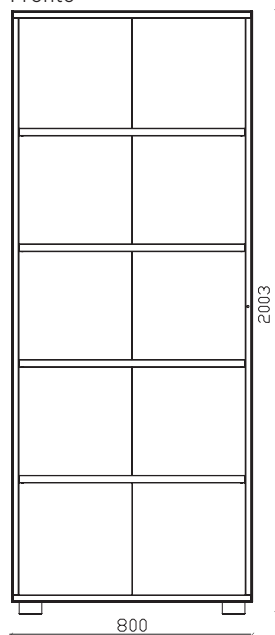

Fianco

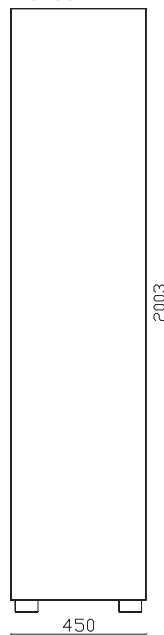

Retro

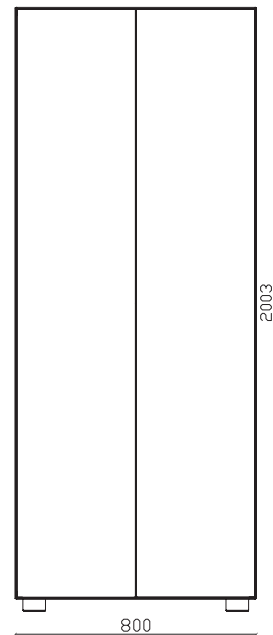

Primo Open Cabinets 800

MADE IN ITALY

Armadio a giorno

5 altezze dox H 2003

L 800 x P 450 x H 2003 mm

DESIGNER Takiro Yuta

DESCRIZIONE Armadio a giorno 5 altezze dox**DIMENSIONI** L 800 mm x P 450 mm x H 2003 mm**ESTERNE****DIMENSIONI** L 751 x P 400 mm x H 1915 mm**INTERNE VANO****DOX** Capienza Dox N° 8 (x5)**CARTELLINE** Capienza 60 (x4) cartelline**PRODUZIONE** > Dieffebi S.p.a.
> Inizio produzione: anno 2018
> Luogo di produzione: Italia**MANUTENZIONE** > Pulire con panno morbido
> Non trattare le superfici con panni abrasivi**MATERIALI** > struttura in metallo riciclato e riciclabile**FINITURA** > Verniciatura a polveri basso emissive (materiale inerte)
> Esenti da metalli pesanti
> Assenza di spigoli vivi e bordi taglienti
> Finitura anti riflesso
> Non contiene VOC**COMPONENTI STANDARD** > Ripiani regolabili: in metallo predisposti per cartelle sospese
> Portata ripiani: 50 Kg
> Piedini regolabili H 40mm
> Viti per assemblaggio**COLORI** > Disponibile in 3 colori standard

V1 Bianco (RAL 9010)

V6 Alluminio (RAL 9006)

V22 Nero (RAL9005)

> Colori standard semilucidi

> Colori personalizzabili su richiesta previa disponibilità e con sovrapprezzo:

www.dieffebi.com/docs/299/2832/DFB_Colour-Chart-2020.pdf**ACCESSORI** > Top di finitura in vetro laccato bianco RAL 9010

> Ripiano aggiuntivo in metallo

> Appendiabiti

> Zoccolo H40mm

> Telaio singolo estraibile e telescopico

> Kit 2 telai estraibili e telescopici con guide ad estrazione totale e sistema di estrazione selettiva (35Kg)

> Kit predisposizione cartelle sospese sotto top
> Cartelline sospese per ripiano armadio Lungh. 330mm

> Cartelline sospese per telaio armadio Lungh. 390mm

> Set 4 piedini H20mm

> Set 4 piedini H 60mm

> possibilità del montaggio porte serie Primo

PESO NETTO 51,50 Kg**IMBALLO** > volume: 0,17 m³
> Film plastico in termoretaibile
> Angolari e canale in cartone
> Ottimizzato per il trasporto con riduzione di CO2
> Fornito: Smontato
> N°colli: 6**END OF USE** > Corredato di scheda di disassemblaggio per smaltimento.**GARANZIA** > Dieffebi garantisce che il prodotto è stato realizzato usando materiali di alta qualità - [Vedi documento di garanzia.](#)

Primo Open Cabinets 800

MADE IN ITALY

Armadio a giorno
5 altezze dox H 2003
L 800 x P 450 x H 2003 mm

DESIGNER Takiro Yuta

BENESSERE E AMBIENTE > Design "green" in accordo con gli standard LEED®, per progettare ed arredare ambienti ad alto contenuto di sostenibilità.



TEST STRUTTURA EN 14073-2:2004, par. 3.4
EN 14073-3:2004, par. 5.2
EN 14073-3:2004, par. 5.3.1
EN 14073-3:2004, par. 5.3.2
EN 14073-3:2004, par. 5.5
EN 14074:2004, par. 6.3.1
EN 14074:2004, par. 6.3.2
EN 14074:2004, par. 6.3.3
UNI 8601:1984
UNI8606:1984

TEST FINITURA UNI EN ISO 2409:2013
NSS UNI EN ISO 9227:2017
UNI EN 15187:2007 EN ISO 1520:2006
UNI EN ISO 6272-1:2013
UNI EN 15185:2011
UNI EN 15186:2012, met.B
UNI 9300:2015
EN 12720:2013
EN 12721:2013
UNI 9429:2015

CLASSE DI REAZIONE AL FUOCO > Classe 0

POSIZIONAMENTO > Sia al muro che in centro stanza



ADIMEMBER



Primo Open Cabinets 800

Vernici Varnish Vernis Lacke

Corpo
Cabinet Body
Caisson
Korpus



-V1
S711 (RAL 9010)
Pure white



-V6
S380 (RAL 9006)
White aluminium

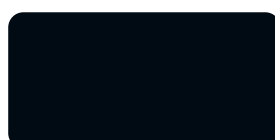

-V22
S811 (RAL 9005)
Jet black

Ripiano aggiuntivo
in metallo
Additional metal shelf
Tablette supplémentaire
en métal
Zusätzlicher
Metallfachboden

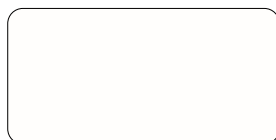

-V1
S711 (RAL 9010)
Pure white



-V6
S380 (RAL 9006)
White aluminium

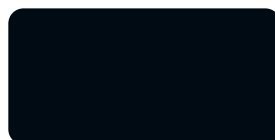

-V22
S811 (RAL 9005)
Jet black

Appendiabiti
Clothes hanger
Tringle
Kleiderstange



-V1
S711 (RAL 9010)
Pure white



-V6
S380 (RAL 9006)
White aluminium



-V22
S811 (RAL 9005)
Jet black

Zoccolo
Plinth
Socle
Sockel

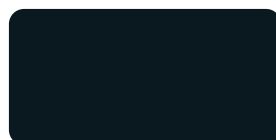

-V1
S210 (RAL 7021)
Black grey

Kit predisposizione cartelle
sospese sotto top
Kit for hanging files under top
of cabinets
Jeu de rails pour dossier
suspendu sous plateau



-V1
S711 (RAL 9010)
Pure white



-V6
S380 (RAL 9006)
White aluminium

Vetro Glass Verre Glas

Top di finitura in vetro
laccato bianco
White lacquered glass top
Plateau en verre laqué
blanc
Glasabdeckplatte weiß
lackiert



-G1
Bianco/White/Blanc/Weiß

Primo Open Cabinets 1000

MADE IN ITALY

Armadio a giorno

1 altezza dox H 723

L 1000 x P 450 x H 723 mm

Struttura: metallo

V1 ○ bianco RAL 9010

art.6PRAW001P S711

V6 ● alluminio RAL 9006

art.6PRAW001P S380

V22 ● nero RAL 9005

art.6PRAW001P S811

DESIGNER Takiro Yuta

Fronte

Fianco

Retro

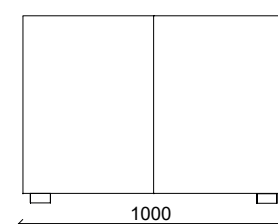
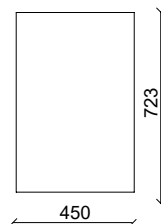
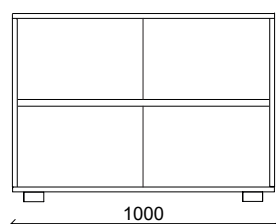
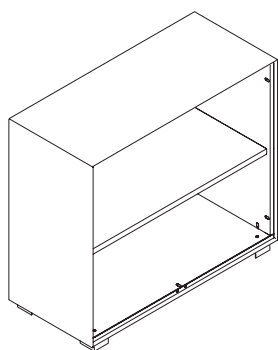

Primo Open Cabinets 1000

MADE IN ITALY

Armadio a giorno

1 altezza dox H 723

L 1000 x P 450 x H 723 mm

DESIGNER Takiro Yuta

DESCRIZIONE Armadio a giorno 1 altezza dox

DIMENSIONI L 1000 mm x P 450 mm x H 723 mm

ESTERNE

DIMENSIONI L 951 x P 400 mm x H 635 mm

INTERNE VANO

DOX Capienza Dox N° 11

CARTELLINE Capienza 76 cartelline

PRODUZIONE

- > Dieffebi S.p.a.
- > Inizio produzione: anno 2018
- > Luogo di produzione: Italia

MANUTENZIONE

- > Pulire con panno morbido
- > Non trattare le superfici con panni abrasivi

MATERIALI > struttura in metallo riciclato e riciclabile

FINITURA

- > Verniciatura a polveri basso emissive (materiale inerte)
- > Esenti da metalli pesanti
- > Assenza di spigoli vivi e bordi taglienti
- > Finitura anti riflesso
- > Non contiene VOC

COMPONENTI STANDARD

- > Ripiani regolabili: in metallo predisposti per cartelle sospese
- > Portata ripiani: 50 Kg
- > Piedini regolabili H 40mm
- > Viti per assemblaggio

COLORI > Disponibile in 3 colori standard

V1 Bianco (RAL 9010)

V6 Alluminio (RAL 9006)

V22 Nero (RAL9005)

> Colori standard semilucidi

> Colori personalizzabili su richiesta previa disponibilità e con sovrapprezzo:

www.dieffebi.com/docs/299/2832/DFB_Colour-Chart-2020.pdf

ACCESSORI > Top di finitura in vetro laccato bianco RAL 9010

> Ripiano aggiuntivo in metallo

> Appendiabiti

> Zoccolo H40mm

> Telaio singolo estraibile e telescopico

> Kit 2 telai estraibili e telescopici con guide ad estrazione totale e sistema di estrazione selettiva (35Kg)

> Kit predisposizione cartelle sospese sotto top

> Cartelline sospese per ripiano armadio Lungh. 330mm

> Cartelline sospese per telaio armadio Lungh. 390mm

> Set 4 piedini H20mm

> Set 4 piedini H 60mm

> possibilità del montaggio porte serie Primo

PESO NETTO 27,90 Kg

IMBALLO > volume: 0,09 m³

> Film plastico in termoretaibile

> Angolari e canale in cartone

> Ottimizzato per il trasporto con riduzione di CO2

> Fornito: Smontato

> N°colli: 6

END OF USE > Corredato di scheda di disassemblaggio per smaltimento.

GARANZIA > Dieffebi garantisce che il prodotto è stato realizzato usando materiali di alta qualità - [Vedi documento di garanzia.](#)

Primo Open Cabinets 1000

MADE IN ITALY

Armadio a giorno
1 altezza dox H 723
L 1000 x P 450 x H 723 mm

DESIGNER Takiro Yuta

BENESSERE E AMBIENTE > Design "green" in accordo con gli standard LEED®, per progettare ed arredare ambienti ad alto contenuto di sostenibilità.



www.GreenTop.com



TEST STRUTTURA EN 14073-2:2004, par. 3.4
EN 14073-3:2004, par. 5.2
EN 14073-3:2004, par. 5.3.1
EN 14073-3:2004, par. 5.3.2
EN 14073-3:2004, par. 5.5
EN 14074:2004, par. 6.3.1
EN 14074:2004, par. 6.3.2
EN 14074:2004, par. 6.3.3
UNI 8601:1984
UNI8606:1984

TEST FINITURA UNI EN ISO 2409:2013
NSS UNI EN ISO 9227:2017
UNI EN 15187:2007 EN ISO 1520:2006
UNI EN ISO 6272-1:2013
UNI EN 15185:2011
UNI EN 15186:2012, met.B
UNI 9300:2015
EN 12720:2013
EN 12721:2013
UNI 9429:2015

CLASSE DI REAZIONE AL FUOCO > Classe 0



dieffebi



MADE IN EUROPE



ASSUFFICIO
ASSOCIAZIONE FIDELIENEGARRECO

ADIMEMBER



consip
acquistinretepa.it
Il Fornitore degli Appalti Pubblici per l'edilizia
www.acquistinretepa.it

Dieffebi SpA

via Palù 36
San Vendemiano,
31020 Treviso - Italia

T +39 0438 4715
F +39 0438 471600
exportsales@dieffebi.com
vendite@dieffebi.com
www.dieffebi.com

Primo Open Cabinets 1000

Vernici Varnish Vernis Lacke

Corpo
Cabinet Body
Caisson
Korpus



-V1
S711 (RAL 9010)
Pure white



-V6
S380 (RAL 9006)
White aluminium



-V22
S811 (RAL 9005)
Jet black

Ripiano aggiuntivo
in metallo
Additional metal shelf
Tablette supplémentaire
en métal
Zusätzlicher
Metallfachboden

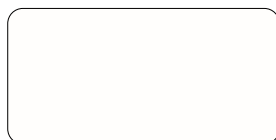

-V1
S711 (RAL 9010)
Pure white



-V6
S380 (RAL 9006)
White aluminium



-V22
S811 (RAL 9005)
Jet black

Appendiabiti
Clothes hanger
Tringle
Kleiderstange



-V1
S711 (RAL 9010)
Pure white



-V6
S380 (RAL 9006)
White aluminium

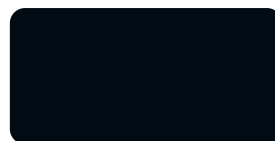

-V22
S811 (RAL 9005)
Jet black

Zoccolo
Plinth
Socle
Sockel



-V1
S210 (RAL 7021)
Black grey

Kit predisposizione cartelle
sospese sotto top
Kit for hanging files under top
of cabinets
Jeu de rails pour dossier
suspendu sous plateau



-V1
S711 (RAL 9010)
Pure white



-V6
S380 (RAL 9006)
White aluminium

Vetro Glass Verre Glas

Top di finitura in vetro
laccato bianco
White lacquered glass top
Plateau en verre laqué
blanc
Glasabdeckplatte weiß
lackiert



-G1
Bianco/White/Blanc/Weiß

Primo Open Cabinets 1000

MADE IN ITALY

Armadio a giorno

2 altezze dox H 883

L 1000 x P 450 x H 883 mm

Struttura: metallo

V1 ○ bianco RAL 9010

V6 ● alluminio RAL 9006

V22 ● nero RAL 9005

art.6PRAW002P S711

art.6PRAW002P S380

art.6PRAW002P S811

DESIGNER Takiro Yuta

Fronte

Fianco

Retro

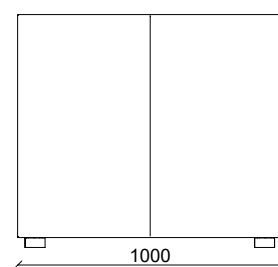
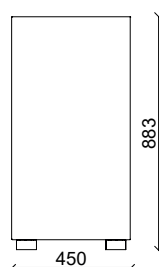
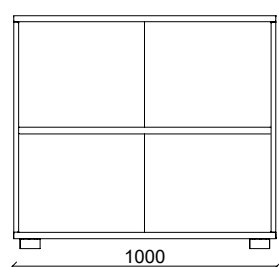
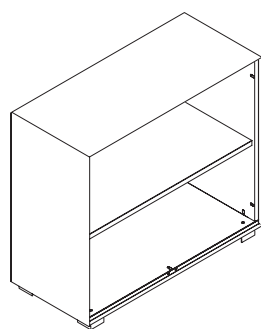

Primo Open Cabinets 1000

MADE IN ITALY

Armadio a giorno
2 altezze dox H 883
L 1000 x P 450 x H 883 mm

DESIGNER Takiro Yuta

| | |
|--------------------------------|---|
| DESCRIZIONE | Armadio a giorno 2 altezze dox |
| DIMENSIONI ESTERNE | L 1000 mm x P 450 mm x H 883 mm |
| DIMENSIONI INTERNE VANO | L 951 x P 400 mm x H 795 mm |
| DOX | Capienza Dox N° 11 (x2) |
| CARTELLINE | Capienza 76 cartelline |
| PRODUZIONE | <ul style="list-style-type: none"> > Dieffebi S.p.a. > Inizio produzione: anno 2018 > Luogo di produzione: Italia |
| MANUTENZIONE | <ul style="list-style-type: none"> > Pulire con panno morbido > Non trattare le superfici con panni abrasivi |
| MATERIALI | > struttura in metallo riciclato e riciclabile |
| FINITURA | <ul style="list-style-type: none"> > Verniciatura a polveri basso emissive (materiale inerte) > Esenti da metalli pesanti > Assenza di spigoli vivi e bordi taglienti > Finitura anti riflesso > Non contiene VOC |
| COMPONENTI STANDARD | <ul style="list-style-type: none"> > Ripiani regolabili: in metallo predisposti per cartelle sospese > Portata ripiani: 50 Kg > Piedini regolabili H 40mm > Viti per assemblaggio |

| | |
|-------------------|--|
| COLORI | <ul style="list-style-type: none"> > Disponibile in 3 colori standard V1 Bianco (RAL 9010) V6 Alluminio (RAL 9006) V22 Nero (RAL9005) > Colori standard semilucidi > Colori personalizzabili su richiesta previa disponibilità e con sovrapprezzo: www.dieffebi.com/docs/299/2832/DFB_Colour-Chart-2020.pdf |
| ACCESSORI | <ul style="list-style-type: none"> > Top di finitura in vetro laccato bianco RAL 9010 > Ripiano aggiuntivo in metallo > Appendiabiti > Zoccolo H40mm > Telaio singolo estraibile e telescopico > Kit 2 telai estraibili e telescopici con guide ad estrazione totale e sistema di estrazione selettiva (35Kg) > Kit predisposizione cartelle sospese sotto top > Cartelline sospese per ripiano armadio Lungh. 330mm > Cartelline sospese per telaio armadio Lungh. 390mm > Set 4 piedini H20mm > Set 4 piedini H 60mm > possibilità del montaggio porte serie Primo |
| PESO NETTO | 30,60 Kg |
| IMBALLO | <ul style="list-style-type: none"> > volume: 0,09 m³ > Film plastico in termoretaibile > Angolari e canale in cartone > Ottimizzato per il trasporto con riduzione di CO2 > Fornito: Smontato > N°colli: 5 |
| END OF USE | > Corredato di scheda di disassemblaggio per smaltimento. |
| GARANZIA | > Dieffebi garantisce che il prodotto è stato realizzato usando materiali di alta qualità - Vedi documento di garanzia. |

Primo Open Cabinets 1000

MADE IN ITALY

Armadio a giorno
2 altezze dox H 883
L 1000 x P 450 x H 883 mm

DESIGNER Takiro Yuta

BENESSERE E AMBIENTE > Design "green" in accordo con gli standard LEED®, per progettare ed arredare ambienti ad alto contenuto di sostenibilità.



www.GreenTop.com



TEST STRUTTURA EN 14073-2:2004, par. 3.4
EN 14073-3:2004, par. 5.2
EN 14073-3:2004, par. 5.3.1
EN 14073-3:2004, par. 5.3.2
EN 14073-3:2004, par. 5.5
EN 14074:2004, par. 6.3.1
EN 14074:2004, par. 6.3.2
EN 14074:2004, par. 6.3.3
UNI 8601:1984
UNI8606:1984

TEST FINITURA UNI EN ISO 2409:2013
NSS UNI EN ISO 9227:2017
UNI EN 15187:2007 EN ISO 1520:2006
UNI EN ISO 6272-1:2013
UNI EN 15185:2011
UNI EN 15186:2012, met.B
UNI 9300:2015
EN 12720:2013
EN 12721:2013
UNI 9429:2015

CLASSE DI REAZIONE AL FUOCO > Classe 0



dieffebi



MADE IN EUROPE



ASSUFFICIO
ASSOCIAZIONE FIDELIENEGARRECO

ADIMEMBER



consip
acquistinretepa.it

Primo Open Cabinets 1000

Vernici
Varnish
Vernis
Lacke

Corpo
Cabinet Body
Caisson
Korpus



-V1
S711 (RAL 9010)
Pure white



-V6
S380 (RAL 9006)
White aluminium

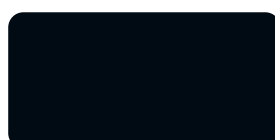

-V22
S811 (RAL 9005)
Jet black

Ripiano aggiuntivo
in metallo
Additional metal shelf
Tablette supplémentaire
en métal
Zusätzlicher
Metallfachboden

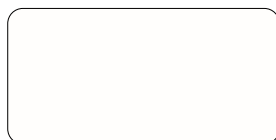

-V1
S711 (RAL 9010)
Pure white



-V6
S380 (RAL 9006)
White aluminium

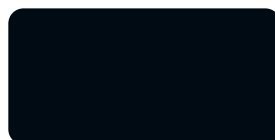

-V22
S811 (RAL 9005)
Jet black

Appendiabiti
Clothes hanger
Tringle
Kleiderstange



-V1
S711 (RAL 9010)
Pure white



-V6
S380 (RAL 9006)
White aluminium



-V22
S811 (RAL 9005)
Jet black

Zoccolo
Plinth
Socle
Sockel



-V1
S210 (RAL 7021)
Black grey

Kit predisposizione cartelle
sospese sotto top
Kit for hanging files under top
of cabinets
Jeu de rails pour dossier
suspendu sous plateau



-V1
S711 (RAL 9010)
Pure white



-V6
S380 (RAL 9006)
White aluminium

Vetro
Glass
Verre
Glas

Top di finitura in vetro
laccato bianco
White lacquered glass top
Plateau en verre laqué
blanc
Glasabdeckplatte weiß
lackiert



-G1
Bianco/White/Blanc/Weiß

Primo Open Cabinets 1000

MADE IN ITALY

Armadio a giorno

2 altezze dox H 1011

L 1000 x P 450 x H 1011 mm

Struttura: metallo

V1 ○ bianco RAL 9010

V6 ● alluminio RAL 9006

V22 ● nero RAL 9005

art.6PRAW003P S711

art.6PRAW003P S380

art.6PRAW003P S811

DESIGNER Takiro Yuta

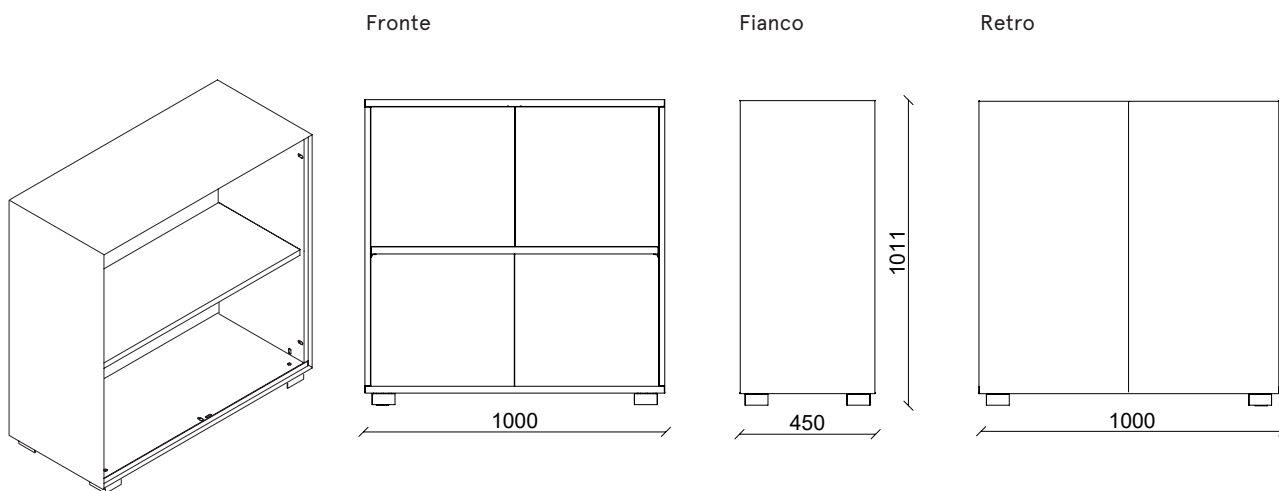

Primo Open Cabinets 1000

MADE IN ITALY

Armadio a giorno
2 altezze dox H 1011
L 1000 x P 450 x H 1011 mm

DESIGNER Takiro Yuta

| | |
|--------------------------------|---|
| DESCRIZIONE | Armadio a giorno 2 altezze dox |
| DIMENSIONI ESTERNE | L 1000 mm x P 450 mm x H 1011 mm |
| DIMENSIONI INTERNE VANO | L 951 x P 400 mm x H 923 mm |
| DOX | Capienza Dox N° 11 (x2) |
| CARTELLINE | Capienza 76 cartelline |
| PRODUZIONE | <ul style="list-style-type: none"> > Dieffebi S.p.a. > Inizio produzione: anno > Luogo di produzione: Italia |
| MANUTENZIONE | <ul style="list-style-type: none"> > Pulire con panno morbido > Non trattare le superfici con panni abrasivi |
| MATERIALI | > struttura in metallo riciclato e riciclabile |
| FINITURA | <ul style="list-style-type: none"> > Verniciatura a polveri basso emissive (materiale inerte) > Esenti da metalli pesanti > Assenza di spigoli vivi e bordi taglienti > Finitura anti riflesso > Non contiene VOC |
| COMPONENTI STANDARD | <ul style="list-style-type: none"> > Ripiani regolabili: in metallo predisposti per cartelle sospese > Portata ripiani: 50 Kg > Piedini regolabili H 40mm > Viti per assemblaggio |

| | |
|-------------------|--|
| COLORI | <ul style="list-style-type: none"> > Disponibile in 3 colori standard V1 Bianco (RAL 9010) V6 Alluminio (RAL 9006) V22 Nero (RAL9005) > Colori standard semilucidi > Colori personalizzabili su richiesta previa disponibilità e con sovrapprezzo: www.dieffebi.com/docs/299/2832/DFB_Colour-Chart-2020.pdf |
| ACCESSORI | <ul style="list-style-type: none"> > Top di finitura in vetro laccato bianco RAL 9010 > Ripiano aggiuntivo in metallo > Appendiabiti > Zoccolo H40mm > Telaio singolo estraibile e telescopico > Kit 2 telai estraibili e telescopici con guide ad estrazione totale e sistema di estrazione selettiva (35Kg) > Kit predisposizione cartelle sospese sotto top > Cartelline sospese per ripiano armadio Lungh. 330mm > Cartelline sospese per telaio armadio Lungh. 390mm > Set 4 piedini H20mm > Set 4 piedini H 60mm > possibilità del montaggio porte serie Primo |
| PESO NETTO | 32,70 Kg |
| IMBALLO | <ul style="list-style-type: none"> > volume: 0,1 m³ > Film plastico in termoretaibile > Angolari e canale in cartone > Ottimizzato per il trasporto con riduzione di CO2 > Fornito: Smontato > N°colli: 5 |
| END OF USE | > Corredato di scheda di disassemblaggio per smaltimento. |
| GARANZIA | > Dieffebi garantisce che il prodotto è stato realizzato usando materiali di alta qualità - Vedi documento di garanzia. |

Primo Open Cabinets 1000

MADE IN ITALY

Armadio a giorno
2 altezze dox H 1011
L 1000 x P 450 x H 1011 mm

DESIGNER Takiro Yuta

BENESSERE E AMBIENTE > Design "green" in accordo con gli standard LEED®, per progettare ed arredare ambienti ad alto contenuto di sostenibilità.



www.GreenTop.com



TEST STRUTTURA EN 14073-2:2004, par. 3.4
EN 14073-3:2004, par. 5.2
EN 14073-3:2004, par. 5.3.1
EN 14073-3:2004, par. 5.3.2
EN 14073-3:2004, par. 5.5
EN 14074:2004, par. 6.3.1
EN 14074:2004, par. 6.3.2
EN 14074:2004, par. 6.3.3
UNI 8601:1984
UNI8606:1984

TEST FINITURA UNI EN ISO 2409:2013
NSS UNI EN ISO 9227:2017
UNI EN 15187:2007 EN ISO 1520:2006
UNI EN ISO 6272-1:2013
UNI EN 15185:2011
UNI EN 15186:2012, met.B
UNI 9300:2015
EN 12720:2013
EN 12721:2013
UNI 9429:2015

CLASSE DI REAZIONE AL FUOCO > Classe 0



dieffebi



MADE IN EUROPE



ASSUFFICIO
ASSOCIAZIONE FIDELIENEGARRECO

ADIMEMBER



consip
acquistinretepa.it

Primo Open Cabinets 1000

Vernici Varnish Vernis Lacke

Corpo
Cabinet Body
Caisson
Korpus



-V1
S711 (RAL 9010)
Pure white



-V6
S380 (RAL 9006)
White aluminium



-V22
S811 (RAL 9005)
Jet black

Ripiano aggiuntivo
in metallo
Additional metal shelf
Tablette supplémentaire
en métal
Zusätzlicher
Metallfachboden

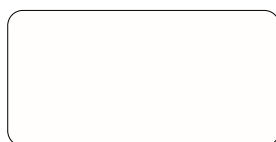

-V1
S711 (RAL 9010)
Pure white



-V6
S380 (RAL 9006)
White aluminium



-V22
S811 (RAL 9005)
Jet black

Appendiabiti
Clothes hanger
Tringle
Kleiderstange



-V1
S711 (RAL 9010)
Pure white



-V6
S380 (RAL 9006)
White aluminium



-V22
S811 (RAL 9005)
Jet black

Zoccolo
Plinth
Socle
Sockel



-V1
S210 (RAL 7021)
Black grey

Kit predisposizione cartelle
sospese sotto top
Kit for hanging files under top
of cabinets
Jeu de rails pour dossier
suspendu sous plateau



-V1
S711 (RAL 9010)
Pure white



-V6
S380 (RAL 9006)
White aluminium

Vetro Glass Verre Glas

Top di finitura in vetro
laccato bianco
White lacquered glass top
Plateau en verre laqué
blanc
Glasabdeckplatte weiß
lackiert



-G1
Bianco/White/Blanc/Weiß

Primo Open Cabinets 1000

MADE IN ITALY

Armadio a giorno

3 altezze dox H 1171

L 1000 x P 450 x H 1171 mm

Struttura: metallo

V1 ○ bianco RAL 9010

art.6PRAW004P S711

V6 ● alluminio RAL 9006

art.6PRAW004P S380

V22 ● nero RAL 9005

art.6PRAW004P S811

DESIGNER Takiro Yuta

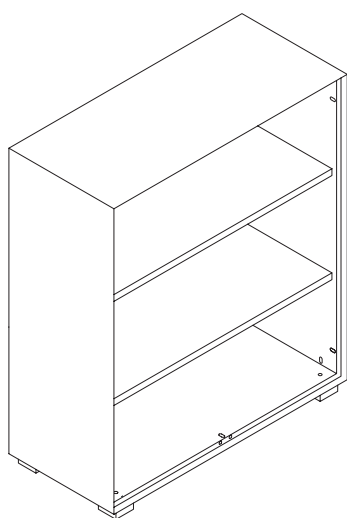

Fronte

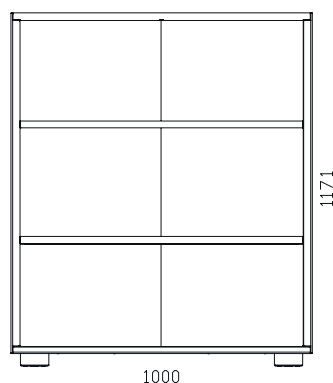

Fianco

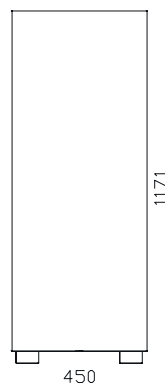

Retro

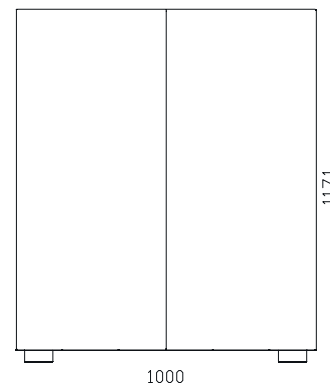

Primo Open Cabinets 1000

MADE IN ITALY

Armadio a giorno
3 altezze dox H 1171
L 1000 x P 450 x H 1171 mm

DESIGNER Takiro Yuta

| | |
|--------------------------------|---|
| DESCRIZIONE | Armadio a giorno 3 altezze dox |
| DIMENSIONI ESTERNE | L 1000 mm x P 450 mm x H 1171 mm |
| DIMENSIONI INTERNE VANO | L 951 x P 400 mm x H 1083 mm |
| DOX | Capienza Dox N° 11 (x3) |
| CARTELLINE | Capienza 76 (x2) cartelline |
| PRODUZIONE | <ul style="list-style-type: none"> > Dieffebi S.p.a. > Inizio produzione: anno 2018 > Luogo di produzione: Italia |
| MANUTENZIONE | <ul style="list-style-type: none"> > Pulire con panno morbido > Non trattare le superfici con panni abrasivi |
| MATERIALI | > struttura in metallo riciclato e riciclabile |
| FINITURA | <ul style="list-style-type: none"> > Verniciatura a polveri basso emissive (materiale inerte) > Esenti da metalli pesanti > Assenza di spigoli vivi e bordi taglienti > Finitura anti riflesso > Non contiene VOC |
| COMPONENTI STANDARD | <ul style="list-style-type: none"> > Ripiani regolabili: in metallo predisposti per cartelle sospese > Portata ripiani: 50 Kg > Piedini regolabili H 40mm > Viti per assemblaggio |

| | |
|-------------------|--|
| COLORI | <ul style="list-style-type: none"> > Disponibile in 3 colori standard V1 Bianco (RAL 9010) V6 Alluminio (RAL 9006) V22 Nero (RAL9005) > Colori standard semilucidi > Colori personalizzabili su richiesta previa disponibilità e con sovrapprezzo: www.dieffebi.com/docs/299/2832/DFB_Colour-Chart-2020.pdf |
| ACCESSORI | <ul style="list-style-type: none"> > Top di finitura in vetro laccato bianco RAL 9010 > Ripiano aggiuntivo in metallo > Appendiabiti > Zoccolo H40mm > Telaio singolo estraibile e telescopico > Kit 2 telai estraibili e telescopici con guide ad estrazione totale e sistema di estrazione selettiva (35Kg) > Kit predisposizione cartelle sospese sotto top > Cartelline sospese per ripiano armadio Lungh. 330mm > Cartelline sospese per telaio armadio Lungh. 390mm > Set 4 piedini H20mm > Set 4 piedini H 60mm > possibilità del montaggio porte serie Primo |
| PESO NETTO | 38,00 Kg |
| IMBALLO | <ul style="list-style-type: none"> > volume: 0,12 m³ > Film plastico in termoretaibile > Angolari e canale in cartone > Ottimizzato per il trasporto con riduzione di CO2 > Fornito: Smontato > N°colli: 5 |
| END OF USE | > Corredato di scheda di disassemblaggio per smaltimento. |
| GARANZIA | > Dieffebi garantisce che il prodotto è stato realizzato usando materiali di alta qualità - Vedi documento di garanzia. |

Primo Open Cabinets 1000

MADE IN ITALY

Armadio a giorno
3 altezze dox H 1171
L 1000 x P 450 x H 1171 mm

DESIGNER Takiro Yuta

BENESSERE E AMBIENTE > Design "green" in accordo con gli standard LEED®, per progettare ed arredare ambienti ad alto contenuto di sostenibilità.



www.GreenTop.com



TEST STRUTTURA EN 14073-2:2004, par. 3.4
EN 14073-3:2004, par. 5.2
EN 14073-3:2004, par. 5.3.1
EN 14073-3:2004, par. 5.3.2
EN 14073-3:2004, par. 5.5
EN 14074:2004, par. 6.3.1
EN 14074:2004, par. 6.3.2
EN 14074:2004, par. 6.3.3
UNI 8601:1984
UNI8606:1984

TEST FINITURA UNI EN ISO 2409:2013
NSS UNI EN ISO 9227:2017
UNI EN 15187:2007 EN ISO 1520:2006
UNI EN ISO 6272-1:2013
UNI EN 15185:2011
UNI EN 15186:2012, met.B
UNI 9300:2015
EN 12720:2013
EN 12721:2013
UNI 9429:2015

CLASSE DI REAZIONE AL FUOCO > Classe 0

POSIZIONAMENTO > Sia al muro che in centro stanza



dieffebi



MADE IN EUROPE



ASSUFFICIO
ASSOCIAZIONE FEDERLEGGIDARREDI

ADIMEMBER



consip
acquistinretepa.it
Il Fornitore Aggiuntivo della Pubblica Amministrazione

Dieffebi SpA

via Palù 36
San Vendemiano,
31020 Treviso - Italia

T +39 0438 4715
F +39 0438 471600
exportsales@dieffebi.com
vendite@dieffebi.com
www.dieffebi.com

Primo Open Cabinets 1000

Vernici Varnish Vernis Lacke

Corpo
Cabinet Body
Caisson
Korpus



-V1
S711 (RAL 9010)
Pure white



-V6
S380 (RAL 9006)
White aluminium

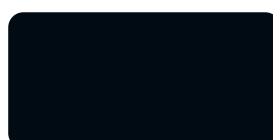

-V22
S811 (RAL 9005)
Jet black

Ripiano aggiuntivo
in metallo
Additional metal shelf
Tablette supplémentaire
en métal
Zusätzlicher
Metallfachboden

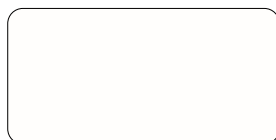

-V1
S711 (RAL 9010)
Pure white



-V6
S380 (RAL 9006)
White aluminium

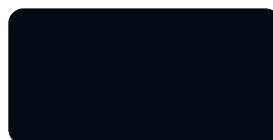

-V22
S811 (RAL 9005)
Jet black

Appendiabiti
Clothes hanger
Tringle
Kleiderstange



-V1
S711 (RAL 9010)
Pure white



-V6
S380 (RAL 9006)
White aluminium



-V22
S811 (RAL 9005)
Jet black

Zoccolo
Plinth
Socle
Sockel



-V1
S210 (RAL 7021)
Black grey

Kit predisposizione cartelle
sospese sotto top
Kit for hanging files under top
of cabinets
Jeu de rails pour dossier
suspendu sous plateau



-V1
S711 (RAL 9010)
Pure white



-V6
S380 (RAL 9006)
White aluminium

Vetro Glass Verre Glas

Top di finitura in vetro
laccato bianco
White lacquered glass top
Plateau en verre laqué
blanc
Glasabdeckplatte weiß
lackiert



-G1
Bianco/White/Blanc/Weiß

Primo Open Cabinets 1000

MADE IN ITALY

Armadio a giorno

3 altezze dox H 1331

L 1000 x P 450 x H 1331 mm

Struttura: metallo

V1 ○ bianco RAL 9010

V6 ● alluminio RAL 9006

V22 ● nero RAL 9005

art.6PRAW005P S711

art.6PRAW005P S380

art.6PRAW005P S811

DESIGNER Takiro Yuta

Fronte

Fianco

Retro

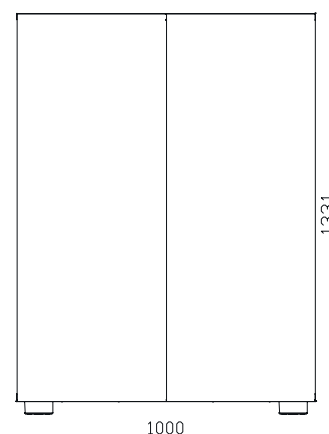
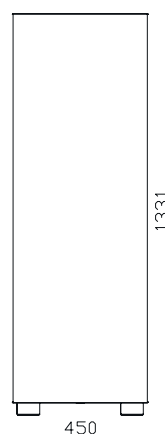
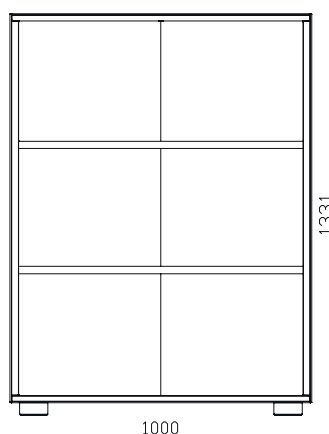
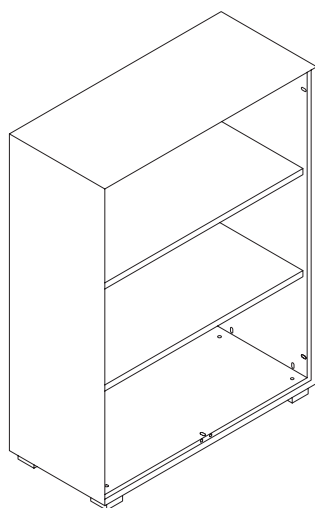

Primo Open Cabinets 1000

MADE IN ITALY

Armadio a giorno

3 altezze dox H 1331

L 1000 x P 450 x H 1331 mm

DESIGNER Takiro Yuta

| | |
|--------------------------------|---|
| DESCRIZIONE | Armadio a giorno 3 altezze dox |
| DIMENSIONI ESTERNE | L 1000 mm x P 450 mm x H 1331 mm |
| DIMENSIONI INTERNE VANO | L 951 x P 400 mm x H 1243 mm |
| DOX | Capienza Dox N° 11 (x3) |
| CARTELLINE | Capienza 76 (x2) cartelline |
| PRODUZIONE | <ul style="list-style-type: none"> > Dieffebi S.p.a. > Inizio produzione: anno > Luogo di produzione: Italia |
| MANUTENZIONE | <ul style="list-style-type: none"> > Pulire con panno morbido > Non trattare le superfici con panni abrasivi |
| MATERIALI | > struttura in metallo riciclato e riciclabile |
| FINITURA | <ul style="list-style-type: none"> > Verniciatura a polveri basso emissive (materiale inerte) > Esenti da metalli pesanti > Assenza di spigoli vivi e bordi taglienti > Finitura anti riflesso > Non contiene VOC |
| COMPONENTI STANDARD | <ul style="list-style-type: none"> > Ripiani regolabili: in metallo predisposti per cartelle sospese > Portata ripiani: 50 Kg > Piedini regolabili H 40mm > Viti per assemblaggio |

| | |
|-------------------|--|
| COLORI | <ul style="list-style-type: none"> > Disponibile in 3 colori standard V1 Bianco (RAL 9010) V6 Alluminio (RAL 9006) V22 Nero (RAL9005) > Colori standard semilucidi > Colori personalizzabili su richiesta previa disponibilità e con sovrapprezzo: www.dieffebi.com/docs/299/2832/DFB_Colour-Chart-2020.pdf |
| ACCESSORI | <ul style="list-style-type: none"> > Top di finitura in vetro laccato bianco RAL 9010 > Ripiano aggiuntivo in metallo > Appendiabiti > Zoccolo H40mm > Telaio singolo estraibile e telescopico > Kit 2 telai estraibili e telescopici con guide ad estrazione totale e sistema di estrazione selettiva (35Kg) > Kit predisposizione cartelle sospese sotto top > Cartelline sospese per ripiano armadio Lungh. 330mm > Cartelline sospese per telaio armadio Lungh. 390mm > Set 4 piedini H20mm > Set 4 piedini H 60mm > possibilità del montaggio porte serie Primo |
| PESO NETTO | 41,00 Kg |
| IMBALLO | <ul style="list-style-type: none"> > volume: 0,13 m³ > Film plastico in termoretaibile > Angolari e canale in cartone > Ottimizzato per il trasporto con riduzione di CO2 > Fornito: Smontato > N°colli: 5 |
| END OF USE | > Corredato di scheda di disassemblaggio per smaltimento. |
| GARANZIA | > Dieffebi garantisce che il prodotto è stato realizzato usando materiali di alta qualità - Vedi documento di garanzia. |

Primo Open Cabinets 1000

MADE IN ITALY

Armadio a giorno
3 altezze dox H 1331
L 1000 x P 450 x H 1331 mm

DESIGNER Takiro Yuta

BENESSERE E AMBIENTE > Design "green" in accordo con gli standard LEED®, per progettare ed arredare ambienti ad alto contenuto di sostenibilità.



TEST STRUTTURA EN 14073-2:2004, par. 3.4
EN 14073-3:2004, par. 5.2
EN 14073-3:2004, par. 5.3.1
EN 14073-3:2004, par. 5.3.2
EN 14073-3:2004, par. 5.5
EN 14074:2004, par. 6.3.1
EN 14074:2004, par. 6.3.2
EN 14074:2004, par. 6.3.3
UNI 8601:1984
UNI8606:1984

TEST FINITURA UNI EN ISO 2409:2013
NSS UNI EN ISO 9227:2017
UNI EN 15187:2007 EN ISO 1520:2006
UNI EN ISO 6272-1:2013
UNI EN 15185:2011
UNI EN 15186:2012, met.B
UNI 9300:2015
EN 12720:2013
EN 12721:2013
UNI 9429:2015

CLASSE DI > Classe 0

REAZIONE AL FUOCO

POSIZIONAMENTO > Sia a muro che in centro stanza



ADIMEMBER



Primo Open Cabinets 1000

Vernici
Varnish
Vernis
Lacke

Corpo
Cabinet Body
Caisson
Korpus



-V1
S711 (RAL 9010)
Pure white



-V6
S380 (RAL 9006)
White aluminium

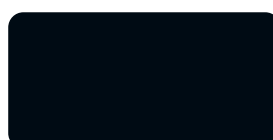

-V22
S811 (RAL 9005)
Jet black

Ripiano aggiuntivo
in metallo
Additional metal shelf
Tablette supplémentaire
en métal
Zusätzlicher
Metallfachboden

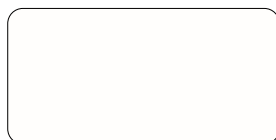

-V1
S711 (RAL 9010)
Pure white



-V6
S380 (RAL 9006)
White aluminium

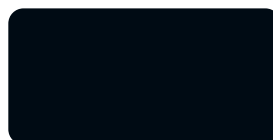

-V22
S811 (RAL 9005)
Jet black

Appendiabiti
Clothes hanger
Tringle
Kleiderstange



-V1
S711 (RAL 9010)
Pure white



-V6
S380 (RAL 9006)
White aluminium



-V22
S811 (RAL 9005)
Jet black

Zoccolo
Plinth
Socle
Sockel



-V1
S210 (RAL 7021)
Black grey

Kit predisposizione cartelle
sospese sotto top
Kit for hanging files under top
of cabinets
Jeu de rails pour dossier
suspendu sous plateau



-V1
S711 (RAL 9010)
Pure white



-V6
S380 (RAL 9006)
White aluminium

Vetro
Glass
Verre
Glas

Top di finitura in vetro
laccato bianco
White lacquered glass top
Plateau en verre laqué
blanc
Glasabdeckplatte weiß
lackiert



-G1
Bianco/White/Blanc/Weiß

Primo Open Cabinets 1000

MADE IN ITALY

Armadio a giorno

4 altezze dox H 1651

L 1000 x P 450 x H 1651 mm

Struttura: metallo

V1 ○ bianco RAL 9010

art.6PRAW006P S711

V6 ● alluminio RAL 9006

art.6PRAW006P S380

V22 ● nero RAL 9005

art.6PRAW006P S811

DESIGNER Takiro Yuta

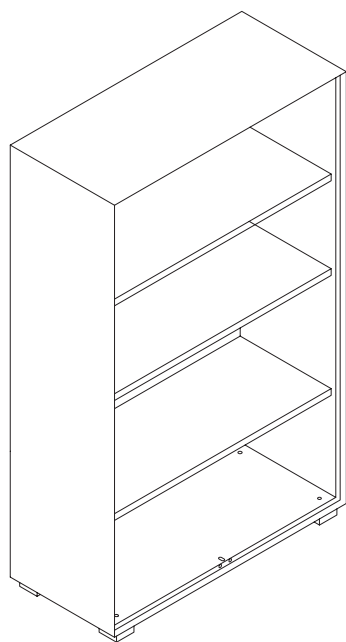

Fronte

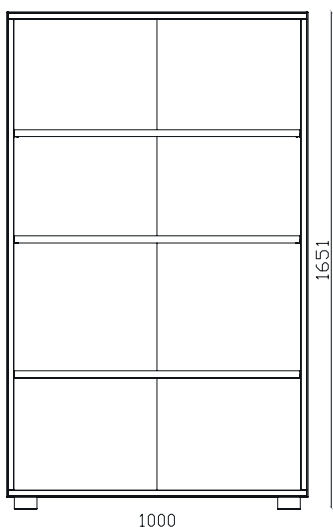

Fianco

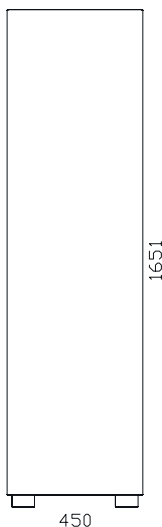

Retro

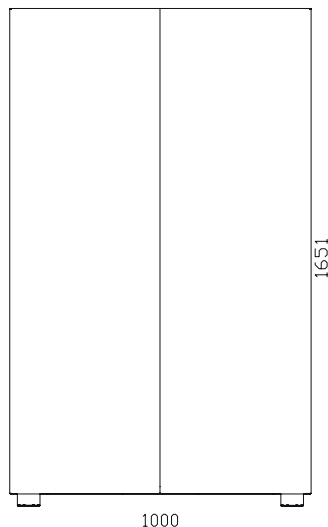

Dieffebi SpA

T +39 0438 4715

F +39 0438 471600

exportsales@dieffebi.com

vendite@dieffebi.com

www.dieffebi.com

Primo Open Cabinets 1000

MADE IN ITALY

Armadio a giorno

4 altezze dox H 1651

L 1000 x P 450 x H 1651 mm

DESIGNER Takiro Yuta

DESCRIZIONE Armadio a giorno 4 altezze dox**DIMENSIONI** L 1000 mm x P 450 mm x H 1651 mm**ESTERNE****DIMENSIONI** L 951 x P 400 mm x H 1563 mm**INTERNE VANO****DOX** Capienza Dox N° 11 (x4)**CARTELLINE** Capienza 76 (x3) cartelline**PRODUZIONE** > Dieffebi S.p.a.

> Inizio produzione: anno 2018

> Luogo di produzione: Italia

MANUTENZIONE > Pulire con panno morbido

> Non trattare le superfici con panni abrasivi

MATERIALI > struttura in metallo riciclato e riciclabile**FINITURA** > Verniciatura a polveri basso emissive (materiale inerte)

> Esenti da metalli pesanti

> Assenza di spigoli vivi e bordi taglienti

> Finitura anti riflesso

> Non contiene VOC

COMPONENTI STANDARD > Ripiani regolabili: in metallo predisposti per cartelle sospese

> Portata ripiani: 50 Kg

> Piedini regolabili H 40mm

> Viti per assemblaggio

COLORI > Disponibile in 3 colori standard

V1 Bianco (RAL 9010)

V6 Alluminio (RAL 9006)

V22 Nero (RAL9005)

> Colori standard semilucidi

> Colori personalizzabili su richiesta previa

disponibilità e con sovrapprezzo:

www.dieffebi.com/docs/299/2832/DFB_Colour-Chart-2020.pdf**ACCESSORI** > Top di finitura in vetro laccato bianco RAL 9010

> Ripiano aggiuntivo in metallo

> Appendiabiti

> Zoccolo H40mm

> Telaio singolo estraibile e telescopico

> Kit 2 telai estraibili e telescopici con guide ad estrazione totale e sistema di estrazione selettiva (35Kg)

> Kit predisposizione cartelle sospese sotto top

> Cartelline sospese per ripiano armadio Lungh. 330mm

> Cartelline sospese per telaio armadio Lungh. 390mm

> Set 4 piedini H20mm

> Set 4 piedini H 60mm

> possibilità del montaggio porte serie Primo

PESO NETTO 49,40 Kg**IMBALLO** > volume: 0,17 m³

> Film plastico in termoretaibile

> Angolari e canale in cartone

> Ottimizzato per il trasporto con riduzione di CO2

> Fornito: Smontato

> N°colli: 6

END OF USE > Corredato di scheda di disassemblaggio per smaltimento.**GARANZIA** > Dieffebi garantisce che il prodotto è stato realizzato usando materiali di alta qualità - [Vedi documento di garanzia.](#)

Primo Open Cabinets 1000

MADE IN ITALY

Armadio a giorno

4 altezze dox H 1651

L 1000 x P 450 x H 1651 mm

DESIGNER Takiro Yuta

BENESSERE E AMBIENTE > Design "green" in accordo con gli standard LEED®, per progettare ed arredare ambienti ad alto contenuto di sostenibilità.



www.GreenTop.com



TEST STRUTTURA EN 14073-2:2004, par. 3.4
 EN 14073-3:2004, par. 5.2
 EN 14073-3:2004, par. 5.3.1
 EN 14073-3:2004, par. 5.3.2
 EN 14073-3:2004, par. 5.5
 EN 14074:2004, par. 6.3.1
 EN 14074:2004, par. 6.3.2
 EN 14074:2004, par. 6.3.3
 UNI 8601:1984
 UNI8606:1984

TEST FINITURA UNI EN ISO 2409:2013
 NSS UNI EN ISO 9227:2017
 UNI EN 15187:2007 EN ISO 1520:2006
 UNI EN ISO 6272-1:2013
 UNI EN 15185:2011
 UNI EN 15186:2012, met.B
 UNI 9300:2015
 EN 12720:2013
 EN 12721:2013
 UNI 9429:2015

CLASSE DI > Classe 0

REAZIONE AL FUOCO

POSIZIONAMENTO > Sia a muro che in centro stanza



dieffebi



MADE IN EUROPE



ASSUFFICIO
 ASSOCIAZIONE FEDERLEASINGARREDO

ADIMEMBER



consip
 acquistinretepa.it
 Il Fornitore Aggiuntivo della Pubblica Amministrazione

Primo Open Cabinets 1000

Vernici Varnish Vernis Lacke

Corpo
Cabinet Body
Caisson
Korpus



-V1
S711 (RAL 9010)
Pure white



-V6
S380 (RAL 9006)
White aluminium



-V22
S811 (RAL 9005)
Jet black

Ripiano aggiuntivo
in metallo
Additional metal shelf
Tablette supplémentaire
en métal
Zusätzlicher
Metallfachboden

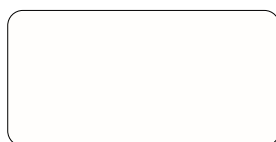

-V1
S711 (RAL 9010)
Pure white



-V6
S380 (RAL 9006)
White aluminium



-V22
S811 (RAL 9005)
Jet black

Appendiabiti
Clothes hanger
Tringle
Kleiderstange



-V1
S711 (RAL 9010)
Pure white



-V6
S380 (RAL 9006)
White aluminium



-V22
S811 (RAL 9005)
Jet black

Zoccolo
Plinth
Socle
Sockel



-V1
S210 (RAL 7021)
Black grey

Kit predisposizione cartelle
sospese sotto top
Kit for hanging files under top
of cabinets
Jeu de rails pour dossier
suspendu sous plateau

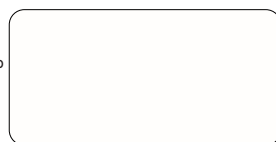

-V1
S711 (RAL 9010)
Pure white



-V6
S380 (RAL 9006)
White aluminium

Vetro Glass Verre Glas

Top di finitura in vetro
laccato bianco
White lacquered glass top
Plateau en verre laqué
blanc
Glasabdeckplatte weiß
lackiert



-G1
Bianco/White/Blanc/Weiß

Primo Open Cabinets 1000

MADE IN ITALY

Armadio a giorno

5 altezze dox H 2003

L 1000 x P 450 x H 2003 mm

Struttura: metallo

V1 ○ bianco RAL 9010

art.6PRAW007P S711

V6 ● alluminio RAL 9006

art.6PRAW007P S380

V22 ● nero RAL 9005

art.6PRAW007P S811

DESIGNER Takiro Yuta

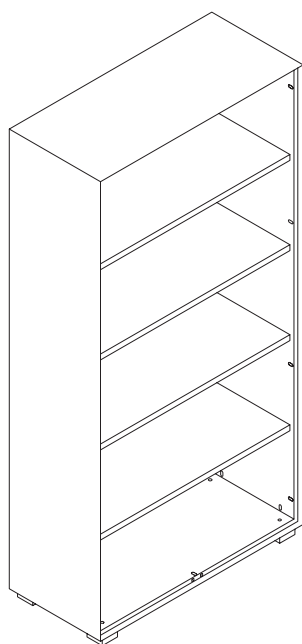

Fronte

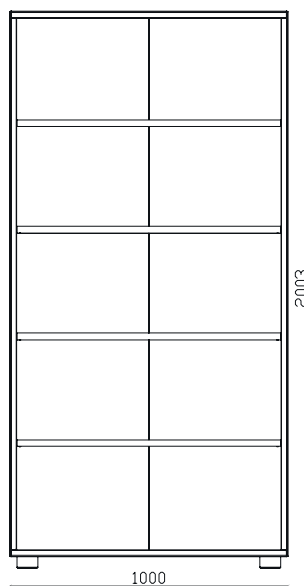

Fianco

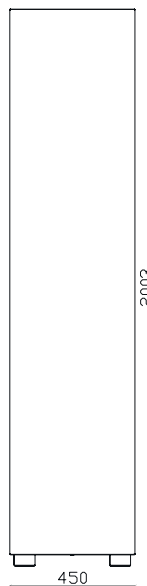

Retro

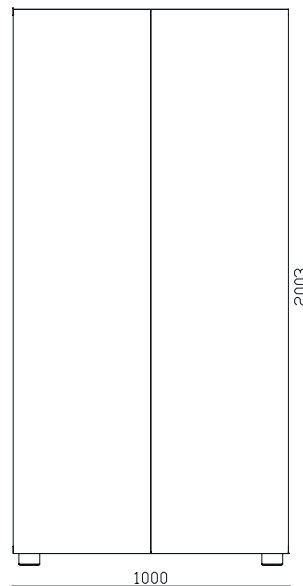

Dieffebi SpA

T +39 0438 4715

F +39 0438 471600

exportsales@dieffebi.com

vendite@dieffebi.com

www.dieffebi.com

Primo Open Cabinets 1000

MADE IN ITALY

Armadio a giorno

5 altezze dox H 2003

L 1000 x P 450 x H 2003 mm

DESIGNER Takiro Yuta

DESCRIZIONE Armadio a giorno 5 altezze dox**DIMENSIONI** L 1000 mm x P 450 mm x H 2003 mm**ESTERNE****DIMENSIONI** L 951 x P 400 mm x H 1915 mm**INTERNE VANO****DOX** Capienza Dox N° 11 (x5)**CARTELLINE** Capienza 76 (x4) cartelline**PRODUZIONE** > Dieffebi S.p.a.
> Inizio produzione: anno 2018
> Luogo di produzione: Italia**MANUTENZIONE** > Pulire con panno morbido
> Non trattare le superfici con panni abrasivi**MATERIALI** > struttura in metallo riciclato e riciclabile**FINITURA** > Verniciatura a polveri basso emissive (materiale inerte)
> Esenti da metalli pesanti
> Assenza di spigoli vivi e bordi taglienti
> Finitura anti riflesso
> Non contiene VOC**COMPONENTI STANDARD** > Ripiani regolabili: in metallo predisposti per cartelle sospese
> Portata ripiani: 50 Kg
> Piedini regolabili H 40mm
> Viti per assemblaggio**COLORI** > Disponibile in 3 colori standard

V1 Bianco (RAL 9010)

V6 Alluminio (RAL 9006)

V22 Nero (RAL9005)

> Colori standard semilucidi

> Colori personalizzabili su richiesta previa disponibilità e con sovrapprezzo:

www.dieffebi.com/docs/299/2832/DFB_Colour-Chart-2020.pdf**ACCESSORI** > Top di finitura in vetro laccato bianco RAL 9010

> Ripiano aggiuntivo in metallo

> Appendiabiti

> Zoccolo H40mm

> Telaio singolo estraibile e telescopico

> Kit 2 telai estraibili e telescopici con guide ad estrazione totale e sistema di estrazione selettiva (35Kg)

> Kit predisposizione cartelle sospese sotto top

> Cartelline sospese per ripiano armadio Lungh. 330mm

> Cartelline sospese per telaio armadio Lungh. 390mm

> Set 4 piedini H20mm

> Set 4 piedini H 60mm

> possibilità del montaggio porte serie Primo

PESO NETTO 58,00 Kg**IMBALLO** > volume: 0,2 m³

> Film plastico in termoretaibile

> Angolari e canale in cartone

> Ottimizzato per il trasporto con riduzione di CO2

> Fornito: Smontato

> N°colli: 6

END OF USE > Corredato di scheda di disassemblaggio per smaltimento.**GARANZIA** > Dieffebi garantisce che il prodotto è stato realizzato usando materiali di alta qualità - [Vedi documento di garanzia.](#)

Primo Open Cabinets 1000

MADE IN ITALY

Armadio a giorno
5 altezze dox H 2003
L 1000 x P 450 x H 2003 mm

DESIGNER Takiro Yuta

BENESSERE E AMBIENTE > Design "green" in accordo con gli standard LEED®, per progettare ed arredare ambienti ad alto contenuto di sostenibilità.



www.GreenTop.com



TEST STRUTTURA EN 14073-2:2004, par. 3.4
EN 14073-3:2004, par. 5.2
EN 14073-3:2004, par. 5.3.1
EN 14073-3:2004, par. 5.3.2
EN 14073-3:2004, par. 5.5
EN 14074:2004, par. 6.3.1
EN 14074:2004, par. 6.3.2
EN 14074:2004, par. 6.3.3
UNI 8601:1984
UNI8606:1984

TEST FINITURA UNI EN ISO 2409:2013
NSS UNI EN ISO 9227:2017
UNI EN 15187:2007 EN ISO 1520:2006
UNI EN ISO 6272-1:2013
UNI EN 15185:2011
UNI EN 15186:2012, met.B
UNI 9300:2015
EN 12720:2013
EN 12721:2013
UNI 9429:2015

CLASSE DI > Classe 0

REAZIONE AL FUOCO

POSIZIONAMENTO > Sia a muro che in centro stanza



dieffebi



MADE IN EUROPE



ASSUFFICIO
ASSOCIAZIONE FEDERLEGGIDARREDI

ADIMEMBER



consip
acquistinretepa.it
Il Fornitore Aggiuntivo della Pubblica Amministrazione

Dieffebi SpA

via Palù 36
San Vendemiano,
31020 Treviso - Italia

T +39 0438 4715
F +39 0438 471600
exportsales@dieffebi.com
vendite@dieffebi.com
www.dieffebi.com

Primo Open Cabinets 1000

Vernici Varnish Vernis Lacke

Corpo
Cabinet Body
Caisson
Korpus



-V1
S711 (RAL 9010)
Pure white



-V6
S380 (RAL 9006)
White aluminium

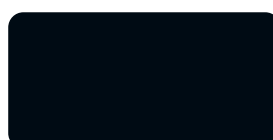

-V22
S811 (RAL 9005)
Jet black

Ripiano aggiuntivo
in metallo
Additional metal shelf
Tablette supplémentaire
en métal
Zusätzlicher
Metallfachboden

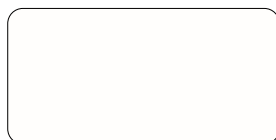

-V1
S711 (RAL 9010)
Pure white



-V6
S380 (RAL 9006)
White aluminium

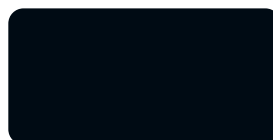

-V22
S811 (RAL 9005)
Jet black

Appendiabiti
Clothes hanger
Tringle
Kleiderstange



-V1
S711 (RAL 9010)
Pure white



-V6
S380 (RAL 9006)
White aluminium



-V22
S811 (RAL 9005)
Jet black

Zoccolo
Plinth
Socle
Sockel



-V1
S210 (RAL 7021)
Black grey

Kit predisposizione cartelle
sospese sotto top
Kit for hanging files under top
of cabinets
Jeu de rails pour dossier
suspendu sous plateau



-V1
S711 (RAL 9010)
Pure white



-V6
S380 (RAL 9006)
White aluminium

Vetro Glass Verre Glas

Top di finitura in vetro
laccato bianco
White lacquered glass top
Plateau en verre laqué
blanc
Glasabdeckplatte weiß
lackiert



-G1
Bianco/White/Blanc/Weiß