

Primo Open Cabinets 800

MADE IN ITALY

Open Cabinet

3 binder heights H 1171
W 800 x D 450 x H 1171 mm

Body: metal

V1 ○ white RAL 9010

art.6PRAW804P S711

V6 ● aluminium RAL 9006

art.6PRAW804P S380

V22 ● black RAL 9005

art.6PRAW804P S811

DESIGNER Takiro Yuta

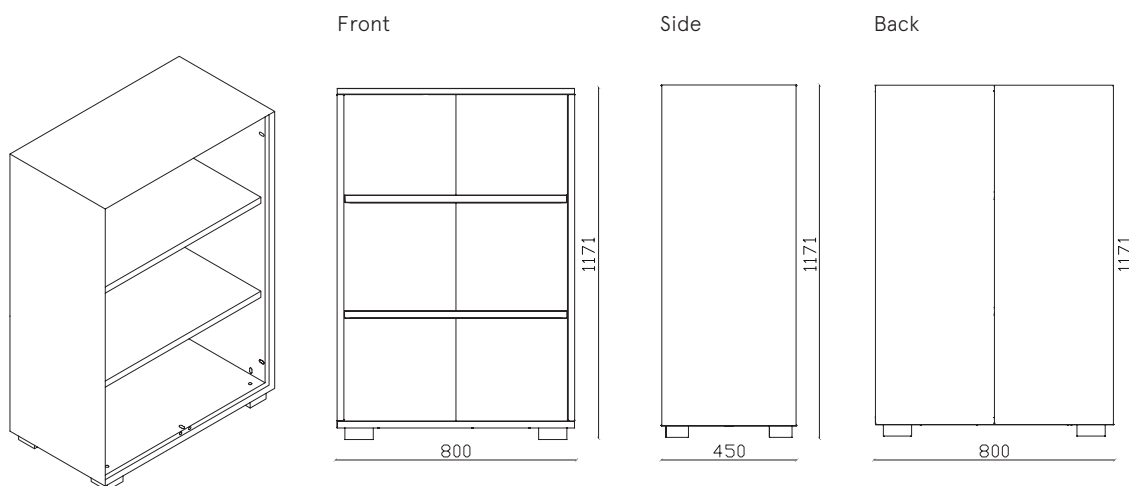

Primo Open Cabinets 800

MADE IN ITALY

Open Cabinet

3 binder heights H 1171

W 800 x D 450 x H 1171 mm

DESIGNER Takiro Yuta

DESCRIPTION	Open Cabinet 3 binder heights
EXTERNAL DIMENSIONS	W 800 mm x D 450 mm x H 1171 mm
INTERNAL DIMENSIONS	W 751 x D 400 mm x H 1083 mm
BINDERS	Capacity: N° 8 (x3)
HANGING FILES	Capacity: 60 (x2) hanging files
PRODUCTION	<ul style="list-style-type: none"> > Dieffebi S.p.a. > Start of production: 2018 > Country of production: Italy
MAINTENANCE	<ul style="list-style-type: none"> > Clean with a soft cloth > Do not treat the surfaces with abrasive cloths
MATERIALS	> Structure made of recycled and recyclable metal
FINISHING	<ul style="list-style-type: none"> > Low-emission powder coating (material inert) > Heavy metals free > Absence of sharp edges > Anti-glare finish > It does not contain VOC
STANDARD COMPONENTS	<ul style="list-style-type: none"> > Height adjustable steel shelves with undershel filing > Shelf load capacity: 50 Kg > Adjustable feet H 40 mm > Assembly screws

COLORS	<ul style="list-style-type: none"> > Available in 3 standard colors: <ul style="list-style-type: none"> V1 White (RAL 9010) V6 Aluminium (RAL 9006) V22 Black (RAL 9005) > Standard semi-gloss colors > Customizable colors available upon request and with an extra charge <p>www.dieffebi.com/docs/299/2832/DFB_Colour-Chart-2020.pdf</p>
ACCESSORIES	<ul style="list-style-type: none"> > White lacquered glass top RAL 9010 > Additional metal shelf > Clothes hanger > Plinth H 40mm > Single pullout and telescopic frame > Kit of 2 extractable and telescopic frames with full extension guides and selective extraction system (35Kg) > Kit for hanging files under top of cabinets > Hanging files for under cabinet shelves, length: 330 mm > Hanging files for under cabinet shelves, length: 390 mm > Set of 4 feet H 20mm > Set of 4 feet H 60 mm > possibility of assembling Primo series doors
NET WEIGHT	34,00 Kg
PACKAGING	<ul style="list-style-type: none"> > volume: 0,11 m³ > Plastic film in heat shrink > Cardboard corners and channel > Optimized for transport with CO2 reduction > Delivered: disassembled > Packages: 5
END OF USE	> Equipped with disassembly card for disposal
WARRANTY	> Dieffebi guarantees that the product was made using high quality materials - See warranty document

Primo Open Cabinets 800

MADE IN ITALY

Open Cabinet

3 binder heights H 1171

W 800 x D 450 x H 1171 mm

DESIGNER Takiro Yuta

WELLNESS AND ENVIRONMENT

> Green design in accordance with LEED® standards, to design and furnish environments with a high sustainability content

www.GreenTop.com

STRUCTURE AND FINISH TEST

Tests equivalent to the Primo Cabinets wardrobe series performed by CATAS
- declaration of conformity available on request

CLASS OF REACTION TO FIRE

> Class 0

POSITIONING

> Both on the wall and in the center of the room



ADIMEMBER



consip
acquistinretepa.it
Il Portale degli Appalti della Pubblica Amministrazione

Dieffebi SpA

T +39 0438 4715
F +39 0438 471600
exportsales@dieffebi.com
vendite@dieffebi.com
www.dieffebi.com

Primo Open Cabinets 800

Varnish Vernici Vernis Lacke

Cabinet Body
Corpo
Caisson
Korpus



-V1
S711 (RAL 9010)
Pure white



-V6
S380 (RAL 9006)
White aluminium



-V22
S811 (RAL 9005)
Jet black

Additional metal shelf
Ripiano aggiuntivo
in metallo
Tablette supplémentaire
en métal
Zusätzlicher
Metallfachboden

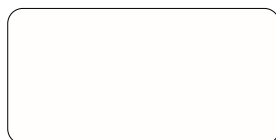

-V1
S711 (RAL 9010)
Pure white



-V6
S380 (RAL 9006)
White aluminium

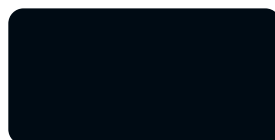

-V22
S811 (RAL 9005)
Jet black

Clothes hanger
Appendiabiti
Tringle
Kleiderstange



-V1
S711 (RAL 9010)
Pure white



-V6
S380 (RAL 9006)
White aluminium



-V22
S811 (RAL 9005)
Jet black

Plinth
Zoccolo
Socle
Sockel

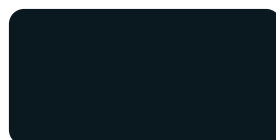

-V1
S210 (RAL 7021)
Black grey

Kit for hanging files under top
of cabinets
Kit predisposizione cartelle
sospese sotto top
Jeu de rails pour dossier
suspendu sous plateau



-V1
S711 (RAL 9010)
Pure white



-V6
S380 (RAL 9006)
White aluminium

Glass Vetro Verre Glas

White lacquered glass top
Top di finitura in vetro
laccato bianco
Plateau en verre laqué
blanc
Glasabdeckplatte weiß
lackiert



-G1
Bianco/White/Blanc/Weiß

Primo Open Cabinets 800

MADE IN ITALY

Open Cabinet

3 binder heights H 1331
W 800 x D 450 x H 1331 mm

Body: metal

V1 ○ white RAL 9010

art.6PRAW805P S711

V6 ● aluminium RAL 9006

art.6PRAW805P S380

V22 ● black RAL 9005

art.6PRAW805P S811

DESIGNER Takiro Yuta

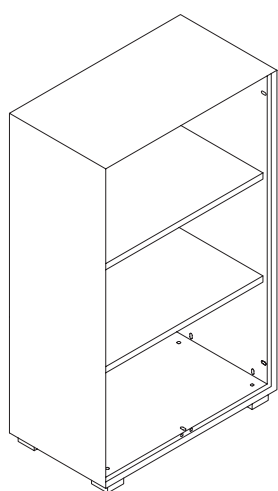

Front

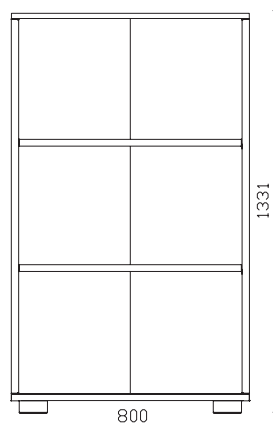

Side

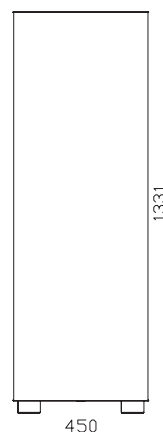

Back

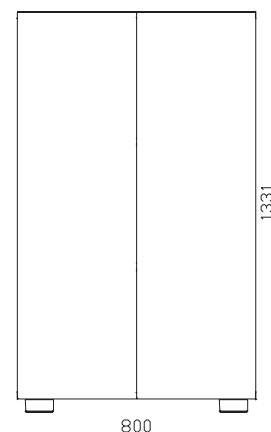

Primo Open Cabinets 800

MADE IN ITALY

Open Cabinet

3 binder heights H 1331

W 800 x D 450 x H 1331 mm

DESIGNER Takiro Yuta

DESCRIPTION	Open Cabinet 3 binder heights
EXTERNAL DIMENSIONS	W 800 mm x D 450 mm x H 1331 mm
INTERNAL DIMENSIONS	W 751 x D 400 mm x H 1243 mm
BINDERS	Capacity: N° 8 (x3)
HANGING FILES	Capacity: 60 (x2) hanging files
PRODUCTION	<ul style="list-style-type: none"> > Dieffebi S.p.a. > Start of production: 2018 > Country of production: Italy
MAINTENANCE	<ul style="list-style-type: none"> > Clean with a soft cloth > Do not treat the surfaces with abrasive cloths
MATERIALS	> Structure made of recycled and recyclable metal
FINISHING	<ul style="list-style-type: none"> > Low-emission powder coating (material inert) > Heavy metals free > Absence of sharp edges > Anti-glare finish > It does not contain VOC
STANDARD COMPONENTS	<ul style="list-style-type: none"> > Height adjustable steel shelves with undershel filing > Shelf load capacity: 50 Kg > Adjustable feet H 40 mm > Assembly screws

COLORS	<ul style="list-style-type: none"> > Available in 3 standard colors: <ul style="list-style-type: none"> V1 White (RAL 9010) V6 Aluminium (RAL 9006) V22 Black (RAL 9005) > Standard semi-gloss colors > Customizable colors available upon request and with an extra charge: <ul style="list-style-type: none"> www.dieffebi.com/docs/299/2832/DFB_Colour-Chart-2020.pdf
ACCESSORIES	<ul style="list-style-type: none"> > White lacquered glass top RAL 9010 > Additional metal shelf > Clothes hanger > Plinth H 40mm > Single pullout and telescopic frame > Kit of 2 extractable and telescopic frames with full extension guides and selective extraction system (35Kg) > Kit for hanging files under top of cabinets > Hanging files for under cabinet shelves, length: 330 mm > Hanging files for under cabinet shelves, length: 390 mm > Set of 4 feet H 20mm > Set of 4 feet H 60 mm > possibility of assembling Primo series doors
NET WEIGHT	36,40 Kg
PACKAGING	<ul style="list-style-type: none"> > volume: 0,12 m³ > Plastic film in heat shrink > Cardboard corners and channel > Optimized for transport with CO2 reduction > Delivered: disassembled > Packages: 5
END OF USE	> Equipped with disassembly card for disposal
WARRANTY	> Dieffebi guarantees that the product was made using high quality materials - See warranty document

Primo Open Cabinets 800

MADE IN ITALY

Open Cabinet
3 binder heights H 1171
W 800 x D 450 x H 1171 mm

DESIGNER Takiro Yuta

WELLNESS AND ENVIRONMENT > Green design in accordance with LEED® standards, to design and furnish environments with a high sustainability content



STRUCTURE AND FINISH TEST Tests equivalent to the Primo Cabinets wardrobe series performed by CATAS
- declaration of conformity available on request

CLASS OF REACTION TO FIRE > Class 0

POSITIONING > Both on the wall and in the center of the room



ADIMEMBER



Dieffebi SpA

3 via Palù 36
San Vendemiano,
31020 Treviso - Italia

T +39 0438 4715
F +39 0438 471600
exportsales@dieffebi.com
vendite@dieffebi.com
www.dieffebi.com

28 06 2021

Primo Open Cabinets 800

Varnish Vernici Vernis Lacke

Cabinet Body
Corpo
Caisson
Korpus

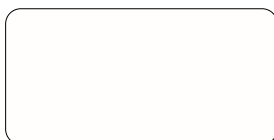

-V1
S711 (RAL 9010)
Pure white



-V6
S380 (RAL 9006)
White aluminium



-V22
S811 (RAL 9005)
Jet black

Additional metal shelf
Ripiano aggiuntivo
in metallo
Tablette supplémentaire
en métal
Zusätzlicher
Metallfachboden



-V1
S711 (RAL 9010)
Pure white



-V6
S380 (RAL 9006)
White aluminium



-V22
S811 (RAL 9005)
Jet black

Clothes hanger
Appendiabiti
Tringle
Kleiderstange

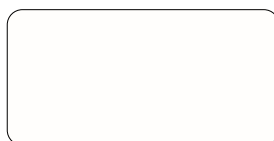

-V1
S711 (RAL 9010)
Pure white



-V6
S380 (RAL 9006)
White aluminium



-V22
S811 (RAL 9005)
Jet black

Plinth
Zoccolo
Socle
Sockel

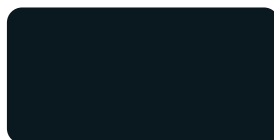

-V1
S210 (RAL 7021)
Black grey

Kit for hanging files under top
of cabinets
Kit predisposizione cartelle
sospese sotto top
Jeu de rails pour dossier
suspendu sous plateau



-V1
S711 (RAL 9010)
Pure white



-V6
S380 (RAL 9006)
White aluminium

Glass Vetro Verre Glas

White lacquered glass top

Top di finitura in vetro
laccato bianco
Plateau en verre laqué
blanc
Glasabdeckplatte weiß
lackiert



-G1
Bianco/White/Blanc/Weiß

Primo Open Cabinets 800

MADE IN ITALY

Open Cabinet

4 binder heights H 1651
L 800 x P 450 x H 1651 mm

Body: metal

V1 ○ white RAL 9010

art.6PRAW806P S711

V6 ● aluminium RAL 9006

art.6PRAW806P S380

V22 ● black RAL 9005

art.6PRAW806P S811

DESIGNER Takiro Yuta

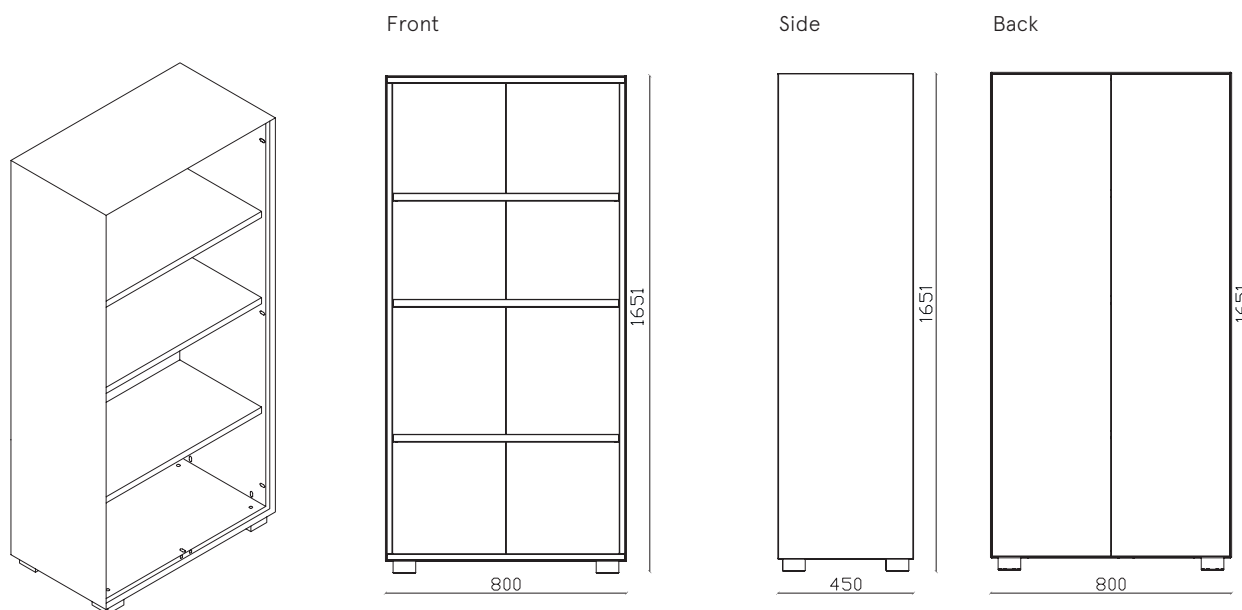

Primo Open Cabinets 800

MADE IN ITALY

Open Cabinet

4 binder heights H 1651

L 800 x P 450 x H 1651 mm

DESIGNER Takiro Yuta

DESCRIPTION	Open Cabinet 4 binder heights
EXTERNAL DIMENSIONS	W 800 mm x D 450 mm x H 1651 mm
INTERNAL DIMENSIONS	W 751 x D 400 mm x H 1563 mm
BINDERS	Capacity: N° 8 (x4)
HANGING FILES	Capacity: 60 (x3) hanging files
PRODUCTION	<ul style="list-style-type: none"> > Dieffebi S.p.a. > Start of production: 2018 > Country of production: Italy
MAINTENANCE	<ul style="list-style-type: none"> > Clean with a soft cloth > Do not treat the surfaces with abrasive cloths
MATERIALS	> Structure made of recycled and recyclable metal
FINISHING	<ul style="list-style-type: none"> > Low-emission powder coating (material inert) > Heavy metals free > Absence of sharp edges > Anti-glare finish > It does not contain VOC
STANDARD COMPONENTS	<ul style="list-style-type: none"> > Height adjustable steel shelves with undershel filing > Shelf load capacity: 50 Kg > Adjustable feet H 40 mm > Assembly screws

COLORS	<ul style="list-style-type: none"> > Available in 3 standard colors: <ul style="list-style-type: none"> V1 White (RAL 9010) V6 Aluminium (RAL 9006) V22 Black (RAL 9005) > Standard semi-gloss colors > Customizable colors available upon request and with an extra charge: <ul style="list-style-type: none"> www.dieffebi.com/docs/299/2832/DFB_Colour-Chart-2020.pdf
ACCESSORIES	<ul style="list-style-type: none"> > White lacquered glass top RAL 9010 > Additional metal shelf > Clothes hanger > Plinth H 40mm > Single pullout and telescopic frame > Kit of 2 extractable and telescopic frames with full extension guides and selective extraction system (35Kg) > Kit for hanging files under top of cabinets > Hanging files for under cabinet shelves, length: 330 mm > Hanging files for under cabinet shelves, length: 390 mm > Set of 4 feet H 20mm > Set of 4 feet H 60 mm > possibility of assembling Primo series doors
NET WEIGHT	43,70 Kg
PACKAGING	<ul style="list-style-type: none"> > volume: 0,14 m³ > Plastic film in heat shrink > Cardboard corners and channel > Optimized for transport with CO2 reduction > Delivered: disassembled > Packages: 6
END OF USE	> Equipped with disassembly card for disposal
WARRANTY	> Dieffebi guarantees that the product was made using high quality materials - See warranty document

Primo Open Cabinets 800

MADE IN ITALY

Open Cabinet

4 binder heights H 1651

L 800 x P 450 x H 1651 mm

DESIGNER Takiro Yuta

WELLNESS AND ENVIRONMENT > Green design in accordance with LEED® standards, to design and furnish environments with a high sustainability content



STRUCTURE AND FINISH TEST Tests equivalent to the Primo Cabinets wardrobe series performed by CATAS
- declaration of conformity available on request

CLASS OF REACTION TO FIRE > Class 0

POSITIONING > Both on the wall and in the center of the room



ADIMEMBER



acquistinretepa.it
Il Portale degli Appalti della Pubblica Amministrazione

Dieffebi SpA

via Palù 36
San Vendemiano,
31020 Treviso - Italia

T +39 0438 4715
F +39 0438 471600
exportsales@dieffebi.com
vendite@dieffebi.com
www.dieffebi.com

Primo Open Cabinets 800

Varnish Vernici Vernis Lacke

Cabinet Body
Corpo
Caisson
Korpus

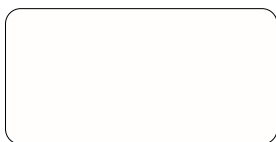

-V1
S711 (RAL 9010)
Pure white



-V6
S380 (RAL 9006)
White aluminium



-V22
S811 (RAL 9005)
Jet black

Additional metal shelf
Ripiano aggiuntivo
in metallo
Tablette supplémentaire
en métal
Zusätzlicher
Metallfachboden

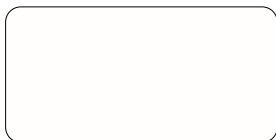

-V1
S711 (RAL 9010)
Pure white



-V6
S380 (RAL 9006)
White aluminium

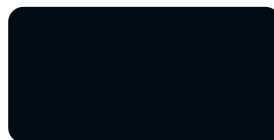

-V22
S811 (RAL 9005)
Jet black

Clothes hanger
Appendiabiti
Tringle
Kleiderstange



-V1
S711 (RAL 9010)
Pure white



-V6
S380 (RAL 9006)
White aluminium



-V22
S811 (RAL 9005)
Jet black

Plinth
Zoccolo
Socle
Sockel

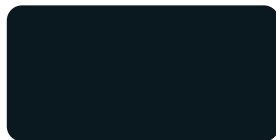

-V1
S210 (RAL 7021)
Black grey

Kit for hanging files under top
of cabinets
Kit predisposizione cartelle
sospese sotto top
Jeu de rails pour dossier
suspendu sous plateau



-V1
S711 (RAL 9010)
Pure white



-V6
S380 (RAL 9006)
White aluminium

Glass Vetro Verre Glas

White lacquered glass top

Top di finitura in vetro
laccato bianco
Plateau en verre laqué
blanc
Glasabdeckplatte weiß
lackiert



-G1
Bianco/White/Blanc/Weiß

Primo Open Cabinets 800

MADE IN ITALY

Open Cabinet

5 binder heights H 2003
W 800 x D 450 x H 2003 mm

Body: metal

V1 ○ white RAL 9010

art.6PRAW807P S711

V6 ● aluminium RAL 9006

art.6PRAW807P S380

V22 ● black RAL 9005

art.6PRAW807P S811

DESIGNER Takiro Yuta

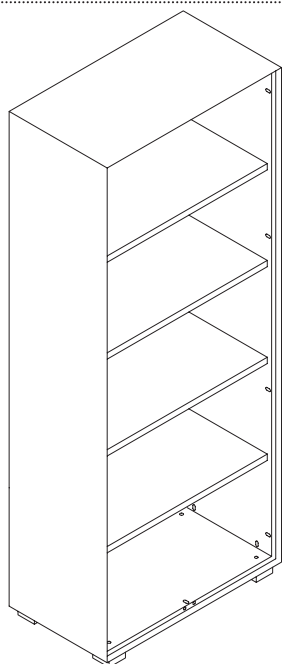

Front

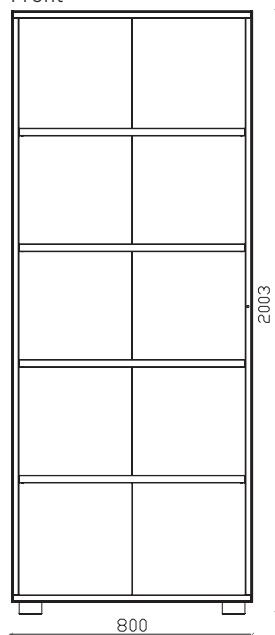

Side

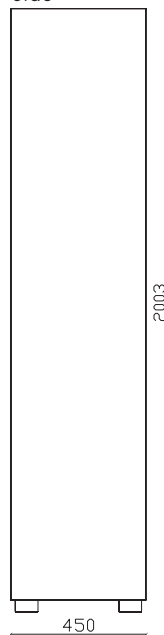

Back

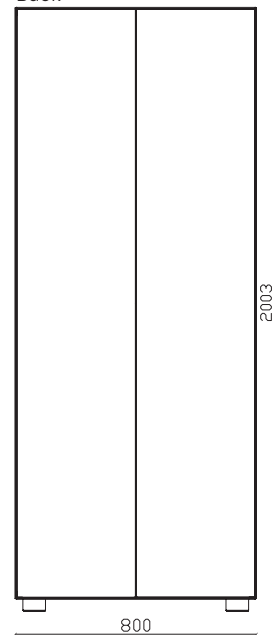

Primo Open Cabinets 800

MADE IN ITALY

Open Cabinet

5 binder heights H 2003

W 800 x D 450 x H 2003 mm

DESIGNER Takiro Yuta

DESCRIPTION	Open Cabinet 4 binder heights
EXTERNAL DIMENSIONS	W 800 mm x D 450 mm x H 2003 mm
INTERNAL DIMENSIONS	W 751 x D 400 mm x H 1915 mm
BINDERS	Capacity: N° 8 (x5)
HANGING FILES	Capacity: 60 (x4) hanging files
PRODUCTION	<ul style="list-style-type: none"> > Dieffebi S.p.a. > Start of production: 2018 > Country of production: Italy
MAINTENANCE	<ul style="list-style-type: none"> > Clean with a soft cloth > Do not treat the surfaces with abrasive cloths
MATERIALS	> Structure made of recycled and recyclable metal
FINISHING	<ul style="list-style-type: none"> > Low-emission powder coating (material inert) > Heavy metals free > Absence of sharp edges > Anti-glare finish > It does not contain VOC
STANDARD COMPONENTS	<ul style="list-style-type: none"> > Height adjustable steel shelves with undershel filing > Shelf load capacity: 50 Kg > Adjustable feet H 40 mm > Assembly screws

COLORS	<ul style="list-style-type: none"> > Available in 3 standard colors: <ul style="list-style-type: none"> V1 White (RAL 9010) V6 Aluminium (RAL 9006) V22 Black (RAL 9005) > Standard semi-gloss colors > Customizable colors available upon request and with an extra charge: <ul style="list-style-type: none"> www.dieffebi.com/docs/299/2832/DFB_Colour-Chart-2020.pdf
ACCESSORIES	<ul style="list-style-type: none"> > Additional metal shelf > Clothes hanger > Plinth H 40mm > Single pullout and telescopic frame > Kit of 2 extractable and telescopic frames with full extension guides and selective extraction system (35Kg) > Kit for hanging files under top of cabinets > Hanging files for under cabinet shelves, length: 330 mm > Hanging files for under cabinet shelves, length: 390 mm > Set of 4 feet H 20mm > Set of 4 feet H 60 mm > possibility of assembling Primo series doors
NET WEIGHT	51,50 Kg
PACKAGING	<ul style="list-style-type: none"> > volume: 0,17 m³ > Plastic film in heat shrink > Cardboard corners and channel > Optimized for transport with CO2 reduction > Delivered: disassembled > Packages: 6
END OF USE	> Equipped with disassembly card for disposal
WARRANTY	> Dieffebi guarantees that the product was made using high quality materials - See warranty document

Primo Open Cabinets 800

MADE IN ITALY

Open Cabinet
5 binder heights H 2003
W 800 x D 450 x H 2003 mm

DESIGNER Takiro Yuta

WELLNESS AND ENVIRONMENT > Green design in accordance with LEED® standards, to design and furnish environments with a high sustainability content



STRUCTURE AND FINISH TEST Tests equivalent to the Primo Cabinets wardrobe series performed by CATAS
- declaration of conformity available on request

CLASS OF REACTION TO FIRE > Class 0

POSITIONING > Both on the wall and in the center of the room



ADIMEMBER



Dieffebi SpA

via Palù 36
San Vendemiano,
31020 Treviso - Italia

T +39 0438 4715
F +39 0438 471600
exportsales@dieffebi.com
vendite@dieffebi.com
www.dieffebi.com

Primo Open Cabinets 800

Varnish Vernici Vernis Lacke

Cabinet Body
Corpo
Caisson
Korpus

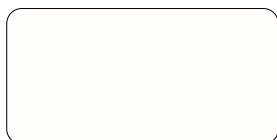

-V1
S711 (RAL 9010)
Pure white



-V6
S380 (RAL 9006)
White aluminium



-V22
S811 (RAL 9005)
Jet black

Additional metal shelf
Ripiano aggiuntivo
in metallo
Tablette supplémentaire
en métal
Zusätzlicher
Metallfachboden



-V1
S711 (RAL 9010)
Pure white



-V6
S380 (RAL 9006)
White aluminium

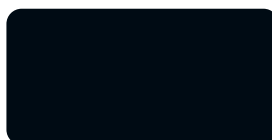

-V22
S811 (RAL 9005)
Jet black

Clothes hanger
Appendiabiti
Tringle
Kleiderstange

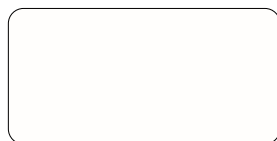

-V1
S711 (RAL 9010)
Pure white



-V6
S380 (RAL 9006)
White aluminium



-V22
S811 (RAL 9005)
Jet black

Plinth
Zoccolo
Socle
Sockel

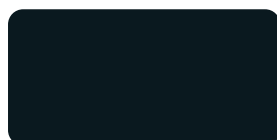

-V1
S210 (RAL 7021)
Black grey

Kit for hanging files under top
of cabinets
Kit predisposizione cartelle
sospese sotto top
Jeu de rails pour dossier
suspendu sous plateau



-V1
S711 (RAL 9010)
Pure white



-V6
S380 (RAL 9006)
White aluminium

Primo Open Cabinets 1000

MADE IN ITALY

Open Cabinet

1 binder height H 723

W 1000 x D 450 x H 723 mm

Body: metal

V1 ○ white RAL 9010

art.6PRAW001P S711

V6 ● aluminium RAL 9006

art.6PRAW001P S380

V22 ● black RAL 9005

art.6PRAW001P S811

DESIGNER Takiro Yuta

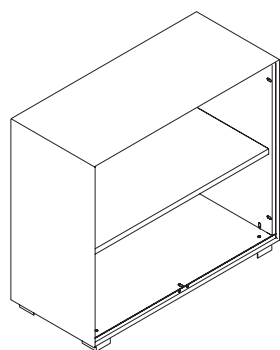

Front

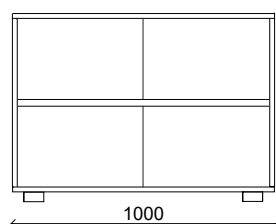

Side

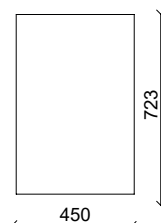

Back

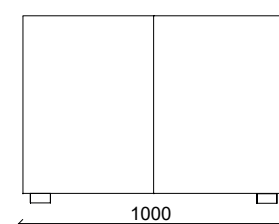

Primo Open Cabinets 1000

MADE IN ITALY

Open Cabinet

1 binder height H 723

W 1000 x D 450 x H 723 mm

DESIGNER Takiro Yuta

DESCRIPTION	Open Cabinet 1 binder height
EXTERNAL DIMENSIONS	W 1000 mm x D 450 mm x H 723 mm
INTERNAL DIMENSIONS	W 951 x D 400 mm x H 635 mm
BINDERS	Capacity: N° 11
HANGING FILES	Capacity: 76 hanging files
PRODUCTION	<ul style="list-style-type: none"> > Dieffebi S.p.a. > Start of production: 2018 > Country of production: Italy
MAINTENANCE	<ul style="list-style-type: none"> > Clean with a soft cloth > Do not treat the surfaces with abrasive cloths
MATERIALS	> Structure made of recycled and recyclable metal
FINISHING	<ul style="list-style-type: none"> > Low-emission powder coating (material inert) > Heavy metals free > Absence of sharp edges > Anti-glare finish > It does not contain VOC
STANDARD COMPONENTS	<ul style="list-style-type: none"> > Height adjustable steel shelves with undershel filing > Shelf load capacity: 50 Kg > Adjustable feet H 40 mm > Assembly screws

COLORS	<ul style="list-style-type: none"> > Available in 3 standard colors: <ul style="list-style-type: none"> V1 White (RAL 9010) V6 Aluminium (RAL 9006) V22 Black (RAL 9005) > Standard semi-gloss colors > Customizable colors available upon request and with an extra charge <p>www.dieffebi.com/docs/299/2832/DFB_Colour-Chart-2020.pdf</p>
ACCESSORIES	<ul style="list-style-type: none"> > White lacquered glass top RAL 9010 > Additional metal shelf > Clothes hanger > Plinth H 40mm > Single pullout and telescopic frame > Kit of 2 extractable and telescopic frames with full extension guides and selective extraction system (35Kg) > Kit for hanging files under top of cabinets > Hanging files for under cabinet shelves, length: 330 mm > Hanging files for under cabinet shelves, length: 390 mm > Set of 4 feet H 20mm > Set of 4 feet H 60 mm > possibility of assembling Primo series doors
NET WEIGHT	27,90 Kg
PACKAGING	<ul style="list-style-type: none"> > volume: 0,09 m³ > Plastic film in heat shrink > Cardboard corners and channel > Optimized for transport with CO2 reduction > Delivered: disassembled > Packages: 6
END OF USE	> Equipped with disassembly card for disposal
WARRANTY	> Dieffebi guarantees that the product was made using high quality materials - See warranty document

Primo Open Cabinets 1000

MADE IN ITALY

Open Cabinet

1 binder height H 723

W 1000 x D 450 x H 723 mm

DESIGNER Takiro Yuta

WELLNESS AND ENVIRONMENT > Green design in accordance with LEED® standards, to design and furnish environments with a high sustainability content



STRUCTURE AND FINISH TEST Tests equivalent to the Primo Cabinets wardrobe series performed by CATAS
- declaration of conformity available on request

CLASS OF REACTION TO FIRE > Class 0

POSITIONING > Both on the wall and in the center of the room



ADIMEMBER



Dieffebi SpA

via Palù 36
San Vendemiano,
31020 Treviso - Italia

T +39 0438 4715
F +39 0438 471600
exportsales@dieffebi.com
vendite@dieffebi.com
www.dieffebi.com

Primo Open Cabinets 1000

Varnish Vernici Vernis Lacke

Cabinet Body
Corpo
Caisson
Korpus



-V1
S711 (RAL 9010)
Pure white



-V6
S380 (RAL 9006)
White aluminium



-V22
S811 (RAL 9005)
Jet black

Additional metal shelf
Ripiano aggiuntivo
in metallo
Tablette supplémentaire
en métal
Zusätzlicher
Metallfachboden

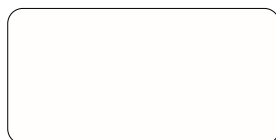

-V1
S711 (RAL 9010)
Pure white



-V6
S380 (RAL 9006)
White aluminium

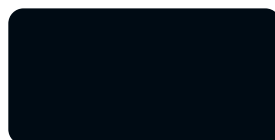

-V22
S811 (RAL 9005)
Jet black

Clothes hanger
Appendiabiti
Tringle
Kleiderstange



-V1
S711 (RAL 9010)
Pure white



-V6
S380 (RAL 9006)
White aluminium



-V22
S811 (RAL 9005)
Jet black

Plinth
Zoccolo
Socle
Sockel



-V1
S210 (RAL 7021)
Black grey

Kit for hanging files under top
of cabinets
Kit predisposizione cartelle
sospese sotto top
Jeu de rails pour dossier
suspendu sous plateau
Set Hängemappenrahmen
unter Platte



-V1
S711 (RAL 9010)
Pure white



-V6
S380 (RAL 9006)
White aluminium

Glass Vetro Verre Glas

White lacquered glass top
Top di finitura in vetro
laccato bianco
Plateau en verre laqué
blanc
Glasabdeckplatte weiß
lackiert



-G1
Bianco/White/Blanc/Weiß

Primo Open Cabinets 1000

MADE IN ITALY

Open Cabinet

2 binder heights H 883
W 1000 x D 450 x H 883 mm

Body: metal

V1 ○ white RAL 9010
V6 ● aluminium RAL 9006
V22 ● black RAL 9005

art.6PRAW002P S711
art.6PRAW002P S380
art.6PRAW002P S811

DESIGNER Takiro Yuta

Front

Side

Back

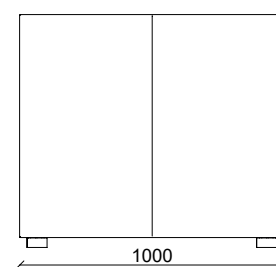
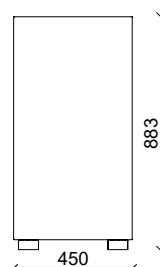
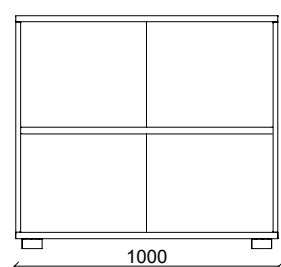
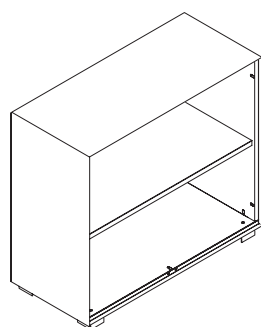

Primo Open Cabinets 1000

MADE IN ITALY

Open Cabinet

2 binder heights H 883

W 1000 x D 450 x H 883 mm

DESIGNER Takiro Yuta

DESCRIPTION	Open Cabinet 2 binder heights
EXTERNAL DIMENSIONS	W 1000 mm x D 450 mm x H 883 mm
INTERNAL DIMENSIONS	W 951 x D 400 mm x H 795 mm
BINDERS	Capacity: N° 11 (x2)
HANGING FILES	Capacity: 76 hanging files
PRODUCTION	<ul style="list-style-type: none"> > Dieffebi S.p.a. > Start of production: 2018 > Country of production: Italy
MAINTENANCE	<ul style="list-style-type: none"> > Clean with a soft cloth > Do not treat the surfaces with abrasive cloths
MATERIALS	> Structure made of recycled and recyclable metal
FINISHING	<ul style="list-style-type: none"> > Low-emission powder coating (material inert) > Heavy metals free > Absence of sharp edges > Anti-glare finish > It does not contain VOC
STANDARD COMPONENTS	<ul style="list-style-type: none"> > Height adjustable steel shelves with undershel filing > Shelf load capacity: 50 Kg > Adjustable feet H 40 mm > Assembly screws

COLORS	<ul style="list-style-type: none"> > Available in 3 standard colors: <ul style="list-style-type: none"> V1 White (RAL 9010) V6 Aluminium (RAL 9006) V22 Black (RAL 9005) > Standard semi-gloss colors > Customizable colors available upon request and with an extra charge: <ul style="list-style-type: none"> www.dieffebi.com/docs/299/2832/DFB_Colour-Chart-2020.pdf
ACCESSORIES	<ul style="list-style-type: none"> > White lacquered glass top RAL 9010 > Additional metal shelf > Clothes hanger > Plinth H 40mm > Single pullout and telescopic frame > Kit of 2 extractable and telescopic frames with full extension guides and selective extraction system (35Kg) > Kit for hanging files under top of cabinets > Hanging files for under cabinet shelves, length: 330 mm > Hanging files for under cabinet shelves, length: 390 mm > Set of 4 feet H 20mm > Set of 4 feet H 60 mm > possibility of assembling Primo series doors
NET WEIGHT	30,60 Kg
PACKAGING	<ul style="list-style-type: none"> > volume: 0,09 m³ > Plastic film in heat shrink > Cardboard corners and channel > Optimized for transport with CO2 reduction > Delivered: disassembled > Packages: 5
END OF USE	> Equipped with disassembly card for disposal
WARRANTY	> Dieffebi guarantees that the product was made using high quality materials - See warranty document

Primo Open Cabinets 1000

MADE IN ITALY

Open Cabinet

2 binder heights H 883

W 1000 x D 450 x H 883 mm

DESIGNER Takiro Yuta

WELLNESS AND ENVIRONMENT > Green design in accordance with LEED® standards, to design and furnish environments with a high sustainability content



STRUCTURE AND FINISH TEST Tests equivalent to the Primo Cabinets wardrobe series performed by CATAS
- declaration of conformity available on request

CLASS OF REACTION TO FIRE > Class 0

POSITIONING > Both on the wall and in the center of the room



ADIMEMBER



Dieffebi SpA

via Palù 36
San Vendemiano,
31020 Treviso - Italia

T +39 0438 4715
F +39 0438 471600
exportsales@dieffebi.com
vendite@dieffebi.com
www.dieffebi.com

Primo Open Cabinets 1000

Varnish Vernici Vernis Lacke

Cabinet Body
Corpo
Caisson
Korpus

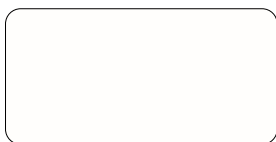

-V1
S711 (RAL 9010)
Pure white



-V6
S380 (RAL 9006)
White aluminium

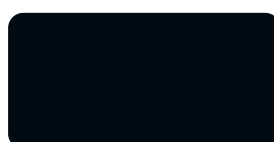

-V22
S811 (RAL 9005)
Jet black

Additional metal shelf
Ripiano aggiuntivo
in metallo
Tablette supplémentaire
en métal
Zusätzlicher
Metallfachboden



-V1
S711 (RAL 9010)
Pure white



-V6
S380 (RAL 9006)
White aluminium

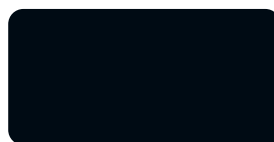

-V22
S811 (RAL 9005)
Jet black

Clothes hanger
Appendiabiti
Tringle
Kleiderstange

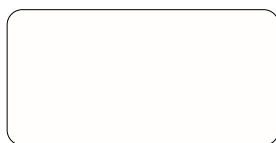

-V1
S711 (RAL 9010)
Pure white



-V6
S380 (RAL 9006)
White aluminium

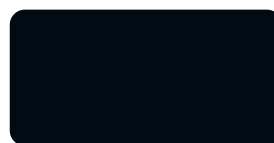

-V22
S811 (RAL 9005)
Jet black

Plinth
Zoccolo
Socle
Sockel

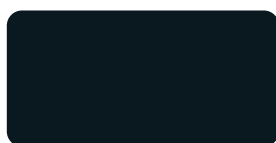

-V1
S210 (RAL 7021)
Black grey

Kit for hanging files under top
of cabinets
Kit predisposizione cartelle
sospese sotto top
Jeu de rails pour dossier
suspendu sous plateau
Set Hängemappenrahmen
unter Platte



-V1
S711 (RAL 9010)
Pure white



-V6
S380 (RAL 9006)
White aluminium

Glass Vetro Verre Glas

White lacquered glass top
Top di finitura in vetro
laccato bianco
Plateau en verre laqué
blanc
Glasabdeckplatte weiß
lackiert



-G1
Bianco/White/Blanc/Weiß

Primo Open Cabinets 1000

MADE IN ITALY

Open Cabinet

2 binder heights H 1011
W 1000 x D 450 x H 1011 mm

Body: metal

V1 ○ white RAL 9010

art.6PRAW003P S711

V6 ● aluminium RAL 9006

art.6PRAW003P S380

V22 ● black RAL 9005

art.6PRAW003P S811

DESIGNER Takiro Yuta

Front

Side

Back

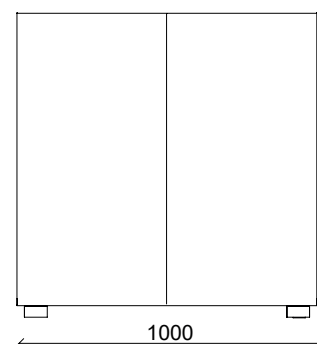
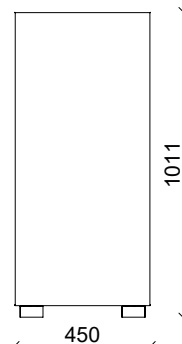
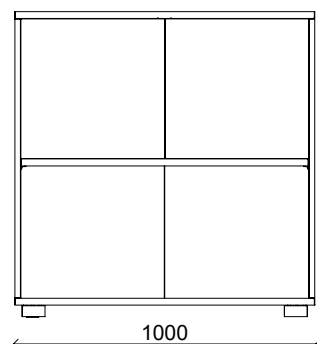
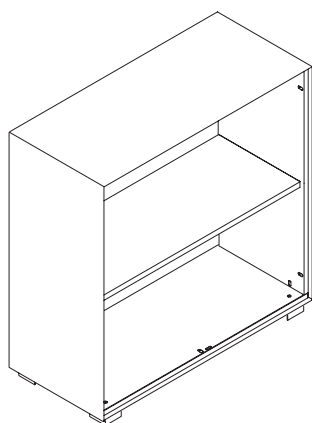

Primo Open Cabinets 1000

MADE IN ITALY

Open Cabinet

2 binder heights H 1011

W 1000 x D 450 x H 1011 mm

DESIGNER Takiro Yuta

DESCRIPTION	Open Cabinet 2 binder heights
EXTERNAL DIMENSIONS	W 1000 mm x D 450 mm x H 1011 mm
INTERNAL DIMENSIONS	W 951 x D 400 mm x H 923 mm
BINDERS	Capacity: N° 11 (x2)
HANGING FILES	Capacity: 76 hanging files
PRODUCTION	<ul style="list-style-type: none"> > Dieffebi S.p.a. > Start of production: 2018 > Country of production: Italy
MAINTENANCE	<ul style="list-style-type: none"> > Clean with a soft cloth > Do not treat the surfaces with abrasive cloths
MATERIALS	> Structure made of recycled and recyclable metal
FINISHING	<ul style="list-style-type: none"> > Low-emission powder coating (material inert) > Heavy metals free > Absence of sharp edges > Anti-glare finish > It does not contain VOC
STANDARD COMPONENTS	<ul style="list-style-type: none"> > Height adjustable steel shelves with undershel filing > Shelf load capacity: 50 Kg > Adjustable feet H 40 mm > Assembly screws

COLORS	<ul style="list-style-type: none"> > Available in 3 standard colors: <ul style="list-style-type: none"> V1 White (RAL 9010) V6 Aluminium (RAL 9006) V22 Black (RAL 9005) > Standard semi-gloss colors > Customizable colors available upon request and with an extra charge: <ul style="list-style-type: none"> www.dieffebi.com/docs/299/2832/DFB_Colour-Chart-2020.pdf
ACCESSORIES	<ul style="list-style-type: none"> > White lacquered glass top RAL 9010 > Additional metal shelf > Clothes hanger > Plinth H 40mm > Single pullout and telescopic frame > Kit of 2 extractable and telescopic frames with full extension guides and selective extraction system (35Kg) > Kit for hanging files under top of cabinets > Hanging files for under cabinet shelves, length: 330 mm > Hanging files for under cabinet shelves, length: 390 mm > Set of 4 feet H 20mm > Set of 4 feet H 60 mm > possibility of assembling Primo series doors
NET WEIGHT	32,70 Kg
PACKAGING	<ul style="list-style-type: none"> > volume: 0,1 m³ > Plastic film in heat shrink > Cardboard corners and channel > Optimized for transport with CO2 reduction > Delivered: disassembled > Packages: 5
END OF USE	> Equipped with disassembly card for disposal
WARRANTY	> Dieffebi guarantees that the product was made using high quality materials - See warranty document

Primo Open Cabinets 1000

MADE IN ITALY

Open Cabinet

2 binder heights H 1011

W 1000 x D 450 x H 1011 mm

DESIGNER Takiro Yuta

WELLNESS AND ENVIRONMENT

> Green design in accordance with LEED® standards, to design and furnish environments with a high sustainability content



STRUCTURE AND FINISH TEST

Tests equivalent to the Primo Cabinets wardrobe series performed by CATAS
- declaration of conformity available on request

CLASS OF REACTION TO FIRE

> Class 0

POSITIONING

> Both on the wall and in the center of the room



ADIMEMBER



consip
acquistinretepa.it
Il Fornitore degli Appalti della Pubblica Amministrazione

Dieffebi SpA

T +39 0438 4715
F +39 0438 471600
exportsales@dieffebi.com
vendite@dieffebi.com
www.dieffebi.com

Primo Open Cabinets 1000

Varnish Vernici Vernis Lacke

Cabinet Body
Corpo
Caisson
Korpus

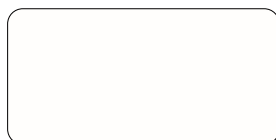

-V1
S711 (RAL 9010)
Pure white



-V6
S380 (RAL 9006)
White aluminium

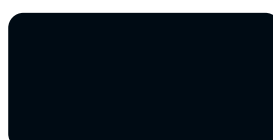

-V22
S811 (RAL 9005)
Jet black

Additional metal shelf
Ripiano aggiuntivo
in metallo
Tablette supplémentaire
en métal
Zusätzlicher
Metallfachboden



-V1
S711 (RAL 9010)
Pure white



-V6
S380 (RAL 9006)
White aluminium



-V22
S811 (RAL 9005)
Jet black

Clothes hanger
Appendiabiti
Tringle
Kleiderstange

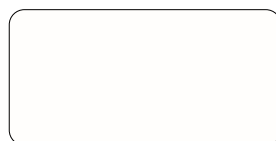

-V1
S711 (RAL 9010)
Pure white



-V6
S380 (RAL 9006)
White aluminium



-V22
S811 (RAL 9005)
Jet black

Plinth
Zoccolo
Socle
Sockel

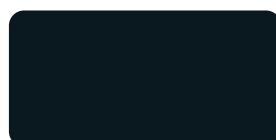

-V1
S210 (RAL 7021)
Black grey

Kit for hanging files under top
of cabinets
Kit predisposizione cartelle
sospese sotto top
Jeu de rails pour dossier
suspendu sous plateau
Set Hängemappenrahmen
unter Platte



-V1
S711 (RAL 9010)
Pure white



-V6
S380 (RAL 9006)
White aluminium

Glass Vetro Verre Glas

White lacquered glass top
Top di finitura in vetro
laccato bianco
Plateau en verre laqué
blanc
Glasabdeckplatte weiß
lackiert



-G1
Bianco/White/Blanc/Weiß

Primo Open Cabinets 1000

MADE IN ITALY

Open Cabinet

3 binder heights H 1171
W 1000 x D 450 x H 1171 mm

Body: metal

V1 ○ white RAL 9010

art.6PRAW004P S711

V6 ● aluminium RAL 9006

art.6PRAW004P S380

V22 ● black RAL 9005

art.6PRAW004P S811

DESIGNER Takiro Yuta

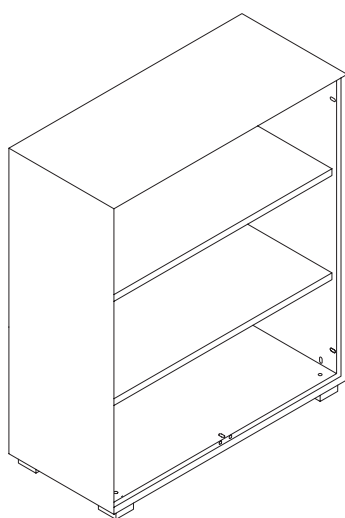

Front

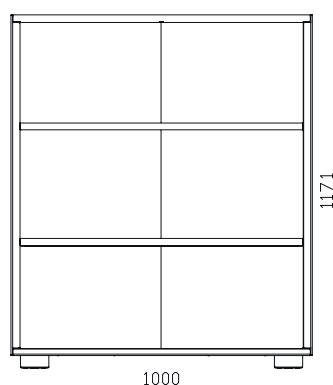

Side

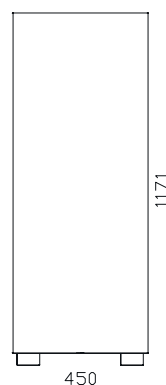

Back

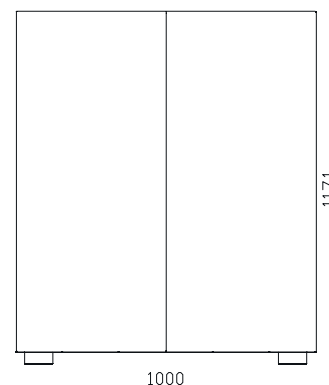

Primo Open Cabinets 1000

MADE IN ITALY

Open Cabinet

3 binder heights H 1171

W 1000 x D 450 x H 1171 mm

DESIGNER Takiro Yuta

DESCRIPTION	Open Cabinet 3 binder heights
EXTERNAL DIMENSIONS	W 1000 mm x D 450 mm x H 1171 mm
INTERNAL DIMENSIONS	W 951 x D 400 mm x H 1083 mm
BINDERS	Capacity: N° 11 (x3)
HANGING FILES	Capacity: 76 (x2) hanging files
PRODUCTION	<ul style="list-style-type: none"> > Dieffebi S.p.a. > Start of production: 2018 > Country of production: Italy
MAINTENANCE	<ul style="list-style-type: none"> > Clean with a soft cloth > Do not treat the surfaces with abrasive cloths
MATERIALS	> Structure made of recycled and recyclable metal
FINISHING	<ul style="list-style-type: none"> > Low-emission powder coating (material inert) > Heavy metals free > Absence of sharp edges > Anti-glare finish > It does not contain VOC
STANDARD COMPONENTS	<ul style="list-style-type: none"> > Height adjustable steel shelves with undershel filing > Shelf load capacity: 50 Kg > Adjustable feet H 40 mm > Assembly screws

COLORS	<ul style="list-style-type: none"> > Available in 3 standard colors: <ul style="list-style-type: none"> V1 White (RAL 9010) V6 Aluminium (RAL 9006) V22 Black (RAL 9005) > Standard semi-gloss colors > Customizable colors available upon request and with an extra charge: <ul style="list-style-type: none"> www.dieffebi.com/docs/299/2832/DFB_Colour-Chart-2020.pdf
ACCESSORIES	<ul style="list-style-type: none"> > White lacquered glass top RAL 9010 > Additional metal shelf > Clothes hanger > Plinth H 40mm > Single pullout and telescopic frame > Kit of 2 extractable and telescopic frames with full extension guides and selective extraction system (35Kg) > Kit for hanging files under top of cabinets > Hanging files for under cabinet shelves, length: 330 mm > Hanging files for under cabinet shelves, length: 390 mm > Set of 4 feet H 20mm > Set of 4 feet H 60 mm > possibility of assembling Primo series doors
NET WEIGHT	38,00 Kg
PACKAGING	<ul style="list-style-type: none"> > volume: 0,12 m³ > Plastic film in heat shrink > Cardboard corners and channel > Optimized for transport with CO2 reduction > Delivered: disassembled > Packages: 5
END OF USE	> Equipped with disassembly card for disposal
WARRANTY	> Dieffebi guarantees that the product was made using high quality materials - See warranty document

Primo Open Cabinets 1000

MADE IN ITALY

Open Cabinet

3 binder heights H 1171

W 1000 x D 450 x H 1171 mm

DESIGNER Takiro Yuta

WELLNESS AND ENVIRONMENT > Green design in accordance with LEED® standards, to design and furnish environments with a high sustainability content



www.GreenTop.com



STRUCTURE AND FINISH TEST Tests equivalent to the Primo Cabinets wardrobe series performed by CATAS
- declaration of conformity available on request

CLASS OF REACTION TO FIRE > Class 0

POSITIONING > Both on the wall and in the center of the room



MADE IN EUROPE

ASSUFFICIO
ASSOCIAZIONE FEDERLEGGISDIRREDO

ADIMEMBER



acquistinretepa.it
Il Portale degli Appalti della Pubblica Amministrazione

Dieffebi SpA

T +39 0438 4715
F +39 0438 471600
exportsales@dieffebi.com
vendite@dieffebi.com
www.dieffebi.com

Primo Open Cabinets 1000

Varnish Vernici Vernis Lacke

Cabinet Body
Corpo
Caisson
Korpus



-V1
S711 (RAL 9010)
Pure white



-V6
S380 (RAL 9006)
White aluminium



-V22
S811 (RAL 9005)
Jet black

Additional metal shelf
Ripiano aggiuntivo
in metallo
Tablette supplémentaire
en métal
Zusätzlicher
Metallfachboden



-V1
S711 (RAL 9010)
Pure white



-V6
S380 (RAL 9006)
White aluminium

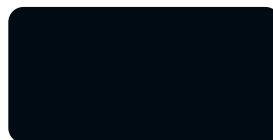

-V22
S811 (RAL 9005)
Jet black

Clothes hanger
Appendiabiti
Tringle
Kleiderstange

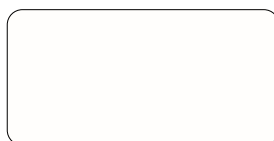

-V1
S711 (RAL 9010)
Pure white



-V6
S380 (RAL 9006)
White aluminium



-V22
S811 (RAL 9005)
Jet black

Plinth
Zoccolo
Socle
Sockel

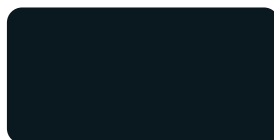

-V1
S210 (RAL 7021)
Black grey

Kit for hanging files under top
of cabinets
Kit predisposizione cartelle
sospese sotto top
Jeu de rails pour dossier
suspendu sous plateau
Set Hängemappenrahmen
unter Platte



-V1
S711 (RAL 9010)
Pure white



-V6
S380 (RAL 9006)
White aluminium

Glass Vetro Verre Glas

White lacquered glass top
Top di finitura in vetro
laccato bianco
Plateau en verre laqué
blanc
Glasabdeckplatte weiß
lackiert



-G1
Bianco/White/Blanc/Weiß

Primo Open Cabinets 1000

MADE IN ITALY

Open Cabinet

3 binder heights H 1331
W 1000 x D 450 x H 1331 mm

Body: metal

V1 ○ white RAL 9010

art.6PRAW005P S711

V6 ● aluminium RAL 9006

art.6PRAW005P S380

V22 ● black RAL 9005

art.6PRAW005P S811

DESIGNER Takiro Yuta

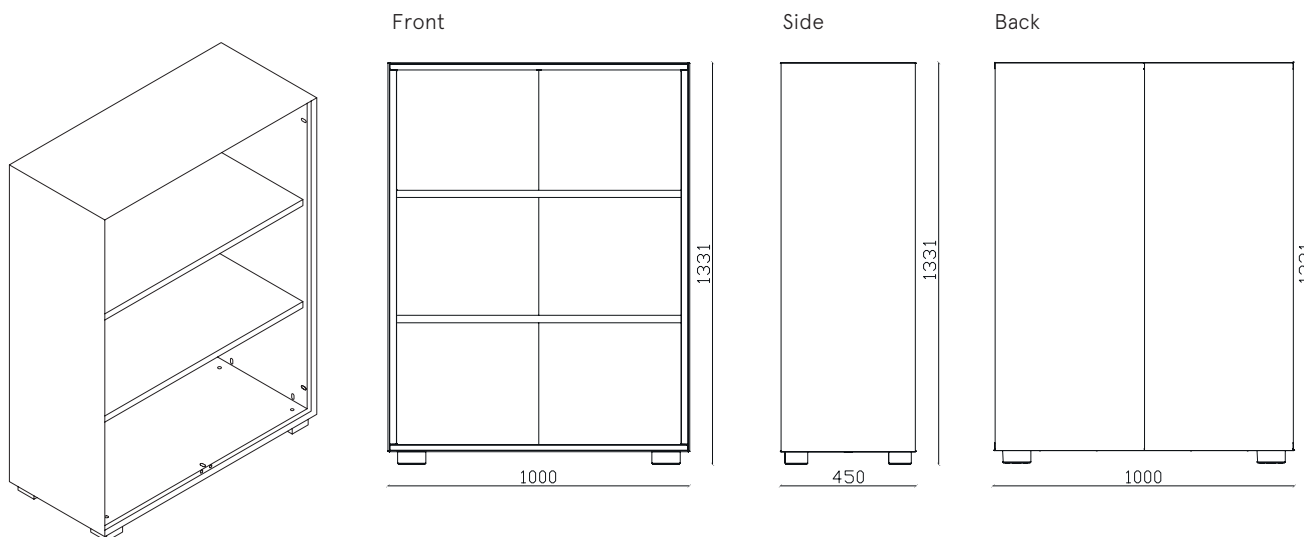

Dieffebi SpA

T +39 0438 4715

F +39 0438 471600

exportsales@dieffebi.com

vendite@dieffebi.com

www.dieffebi.com

Primo Open Cabinets 1000

MADE IN ITALY

Open Cabinet

3 binder heights H 1331

W 1000 x D 450 x H 1331 mm

DESIGNER Takiro Yuta

DESCRIPTION	Open Cabinet 3 binder heights
EXTERNAL DIMENSIONS	W 1000 mm x D 450 mm x H 1331 mm
INTERNAL DIMENSIONS	W 951 x D 400 mm x H 1243 mm
BINDERS	Capacity: N° 11 (x3)
HANGING FILES	Capacity: 76 (x2) hanging files
PRODUCTION	<ul style="list-style-type: none"> > Dieffebi S.p.a. > Start of production: 2018 > Country of production: Italy
MAINTENANCE	<ul style="list-style-type: none"> > Clean with a soft cloth > Do not treat the surfaces with abrasive cloths
MATERIALS	> Structure made of recycled and recyclable metal
FINISHING	<ul style="list-style-type: none"> > Low-emission powder coating (material inert) > Heavy metals free > Absence of sharp edges > Anti-glare finish > It does not contain VOC
STANDARD COMPONENTS	<ul style="list-style-type: none"> > Height adjustable steel shelves with undershel filing > Shelf load capacity: 50 Kg > Adjustable feet H 40 mm > Assembly screws

COLORS	<ul style="list-style-type: none"> > Available in 3 standard colors: <ul style="list-style-type: none"> V1 White (RAL 9010) V6 Aluminium (RAL 9006) V22 Black (RAL 9005) > Standard semi-gloss colors > Customizable colors available upon request and with an extra charge: <ul style="list-style-type: none"> www.dieffebi.com/docs/299/2832/DFB_Colour-Chart-2020.pdf
ACCESSORIES	<ul style="list-style-type: none"> > White lacquered glass top RAL 9010 > Additional metal shelf > Clothes hanger > Plinth H 40mm > Single pullout and telescopic frame > Kit of 2 extractable and telescopic frames with full extension guides and selective extraction system (35Kg) > Kit for hanging files under top of cabinets > Hanging files for under cabinet shelves, length: 330 mm > Hanging files for under cabinet shelves, length: 390 mm > Set of 4 feet H 20mm > Set of 4 feet H 60 mm > possibility of assembling Primo series doors
NET WEIGHT	41,00 Kg
PACKAGING	<ul style="list-style-type: none"> > volume: 0,13 m³ > Plastic film in heat shrink > Cardboard corners and channel > Optimized for transport with CO2 reduction > Delivered: disassembled > Packages: 5
END OF USE	> Equipped with disassembly card for disposal
WARRANTY	> Dieffebi guarantees that the product was made using high quality materials - See warranty document

Primo Open Cabinets 1000

MADE IN ITALY

Open Cabinet

3 binder heights H 1331

W 1000 x D 450 x H 1331 mm

DESIGNER Takiro Yuta

WELLNESS AND ENVIRONMENT > Green design in accordance with LEED® standards, to design and furnish environments with a high sustainability content



www.GreenTop.com



STRUCTURE AND FINISH TEST Tests equivalent to the Primo Cabinets wardrobe series performed by CATAS
- declaration of conformity available on request

CLASS OF REACTION TO FIRE > Class 0

POSITIONING > Both on the wall and in the center of the room



MADE IN EUROPE

ASSUFFICIO
ASSOCIAZIONE FIDELIENSIARDRECO

ADIMEMBER



consip
acquistinretepa.it
Il Fornitore Aggiunto della Pubblica Amministrazione

Dieffebi SpA

T +39 0438 4715
F +39 0438 471600
exportsales@dieffebi.com
vendite@dieffebi.com
www.dieffebi.com

Primo Open Cabinets 1000

Varnish Vernici Vernis Lacke

Cabinet Body
Corpo
Caisson
Korpus

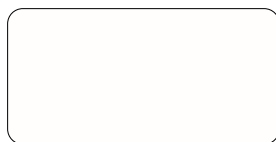

-V1
S711 (RAL 9010)
Pure white



-V6
S380 (RAL 9006)
White aluminium



-V22
S811 (RAL 9005)
Jet black

Additional metal shelf
Ripiano aggiuntivo
in metallo
Tablette supplémentaire
en métal
Zusätzlicher
Metallfachboden



-V1
S711 (RAL 9010)
Pure white



-V6
S380 (RAL 9006)
White aluminium

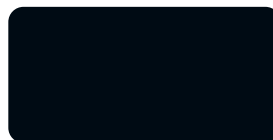

-V22
S811 (RAL 9005)
Jet black

Clothes hanger
Appendiabiti
Tringle
Kleiderstange



-V1
S711 (RAL 9010)
Pure white



-V6
S380 (RAL 9006)
White aluminium

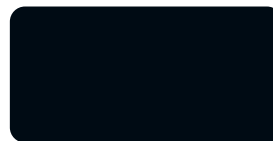

-V22
S811 (RAL 9005)
Jet black

Plinth
Zoccolo
Socle
Sockel

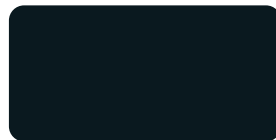

-V1
S210 (RAL 7021)
Black grey

Kit for hanging files under top
of cabinets
Kit predisposizione cartelle
sospese sotto top
Jeu de rails pour dossier
suspendu sous plateau
Set Hängemappenrahmen
unter Platte



-V1
S711 (RAL 9010)
Pure white



-V6
S380 (RAL 9006)
White aluminium

Glass Vetro Verre Glas

White lacquered glass top
Top di finitura in vetro
laccato bianco
Plateau en verre laqué
blanc
Glasabdeckplatte weiß
lackiert



-G1
Bianco/White/Blanc/Weiß

Primo Open Cabinets 1000

MADE IN ITALY

Open Cabinet

4 binder heights H 1651
W 1000 x D 450 x H 1651 mm

Body: metal

V1 ○ white RAL 9010

art.6PRAW006P S711

V6 ● aluminium RAL 9006

art.6PRAW006P S380

V22 ● black RAL 9005

art.6PRAW006P S811

DESIGNER Takiro Yuta

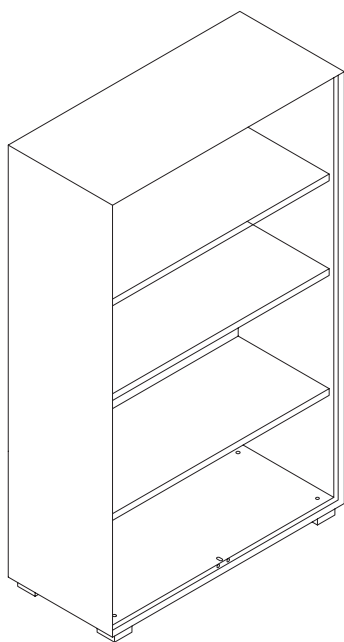

Front

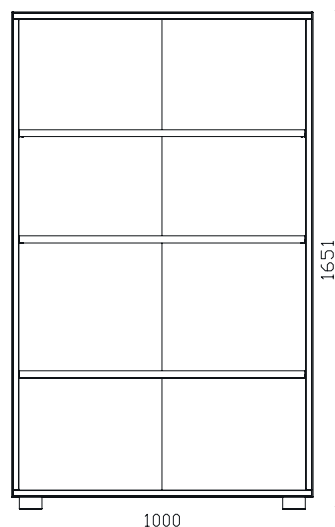

Side

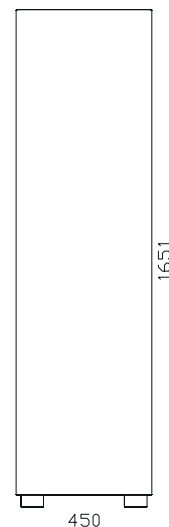

Back

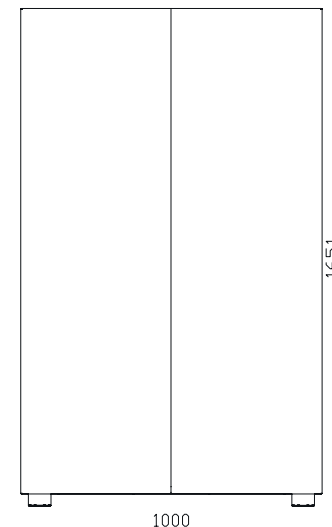

Primo Open Cabinets 1000

MADE IN ITALY

Open Cabinet

4 binder heights H 1651

W 1000 x D 450 x H 1651 mm

DESIGNER Takiro Yuta

DESCRIPTION	Open Cabinet 4 binder heights
EXTERNAL DIMENSIONS	W 1000 mm x D 450 mm x H 1651 mm
INTERNAL DIMENSIONS	W 951 x D 400 mm x H 1563 mm
BINDERS	Capacity: N° 11 (x4)
HANGING FILES	Capacity: 76 (x3) hanging files
PRODUCTION	<ul style="list-style-type: none"> > Dieffebi S.p.a. > Start of production: 2018 > Country of production: Italy
MAINTENANCE	<ul style="list-style-type: none"> > Clean with a soft cloth > Do not treat the surfaces with abrasive cloths
MATERIALS	> Structure made of recycled and recyclable metal
FINISHING	<ul style="list-style-type: none"> > Low-emission powder coating (material inert) > Heavy metals free > Absence of sharp edges > Anti-glare finish > It does not contain VOC
STANDARD COMPONENTS	<ul style="list-style-type: none"> > Height adjustable steel shelves with undershel filing > Shelf load capacity: 50 Kg > Adjustable feet H 40 mm > Assembly screws

COLORS	<ul style="list-style-type: none"> > Available in 3 standard colors: <ul style="list-style-type: none"> V1 White (RAL 9010) V6 Aluminium (RAL 9006) V22 Black (RAL 9005) > Standard semi-gloss colors > Customizable colors available upon request and with an extra charge: <ul style="list-style-type: none"> www.dieffebi.com/docs/299/2832/DFB_Colour-Chart-2020.pdf
ACCESSORIES	<ul style="list-style-type: none"> > White lacquered glass top RAL 9010 > Additional metal shelf > Clothes hanger > Plinth H 40mm > Single pullout and telescopic frame > Kit of 2 extractable and telescopic frames with full extension guides and selective extraction system (35Kg) > Kit for hanging files under top of cabinets > Hanging files for under cabinet shelves, length: 330 mm > Hanging files for under cabinet shelves, length: 390 mm > Set of 4 feet H 20mm > Set of 4 feet H 60 mm > possibility of assembling Primo series doors
NET WEIGHT	49,40 Kg
PACKAGING	<ul style="list-style-type: none"> > volume: 0,17 m³ > Plastic film in heat shrink > Cardboard corners and channel > Optimized for transport with CO2 reduction > Delivered: disassembled > Packages: 6
END OF USE	> Equipped with disassembly card for disposal
WARRANTY	> Dieffebi guarantees that the product was made using high quality materials - See warranty document

Primo Open Cabinets 1000

MADE IN ITALY

Open Cabinet

4 binder heights H 1651

W 1000 x D 450 x H 1651 mm

DESIGNER Takiro Yuta

WELLNESS AND ENVIRONMENT > Green design in accordance with LEED® standards, to design and furnish environments with a high sustainability content



www.GreenTop.com



STRUCTURE AND FINISH TEST Tests equivalent to the Primo Cabinets wardrobe series performed by CATAS
- declaration of conformity available on request

CLASS OF REACTION TO FIRE > Class 0

POSITIONING > Both on the wall and in the center of the room



MADE IN EUROPE

ASSUFFICIO
ASSOCIAZIONE FEDERLEGGISDIRRECCI

ADIMEMBER



acquistinretepa.it
Il Portale degli Appalti della Pubblica Amministrazione

Dieffebi SpA

via Palù 36
San Vendemiano,
31020 Treviso - Italia

T +39 0438 4715
F +39 0438 471600
exportsales@dieffebi.com
vendite@dieffebi.com
www.dieffebi.com

Primo Open Cabinets 1000

Varnish Vernici Vernis Lacke

Cabinet Body
Corpo
Caisson
Korpus

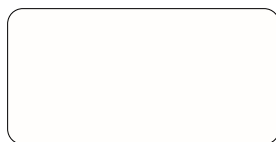

-V1
S711 (RAL 9010)
Pure white



-V6
S380 (RAL 9006)
White aluminium

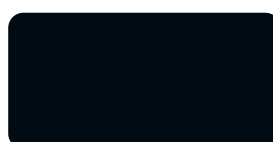

-V22
S811 (RAL 9005)
Jet black

Additional metal shelf
Ripiano aggiuntivo
in metallo
Tablette supplémentaire
en métal
Zusätzlicher
Metallfachboden



-V1
S711 (RAL 9010)
Pure white



-V6
S380 (RAL 9006)
White aluminium

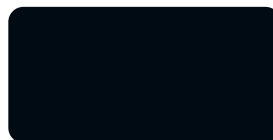

-V22
S811 (RAL 9005)
Jet black

Clothes hanger
Appendiabiti
Tringle
Kleiderstange

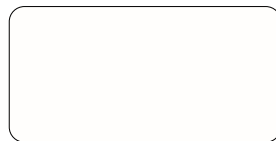

-V1
S711 (RAL 9010)
Pure white



-V6
S380 (RAL 9006)
White aluminium



-V22
S811 (RAL 9005)
Jet black

Plinth
Zoccolo
Socle
Sockel

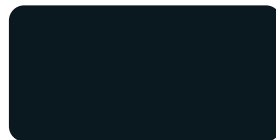

-V1
S210 (RAL 7021)
Black grey

Kit for hanging files under top
of cabinets
Kit predisposizione cartelle
sospese sotto top
Jeu de rails pour dossier
suspendu sous plateau
Set Hängemappenrahmen
unter Platte



-V1
S711 (RAL 9010)
Pure white



-V6
S380 (RAL 9006)
White aluminium

Glass Vetro Verre Glas

White lacquered glass top
Top di finitura in vetro
laccato bianco
Plateau en verre laqué
blanc
Glasabdeckplatte weiß
lackiert



-G1
Bianco/White/Blanc/Weiß

Primo Open Cabinets 1000

MADE IN ITALY

Open Cabinet

5 binder heights H 2003
W 1000 x D 450 x H 2003 mm

Body: metal

V1 ○ white RAL 9010

art.6PRAW007P S711

V6 ● aluminium RAL 9006

art.6PRAW007P S380

V22 ● black RAL 9005

art.6PRAW007P S811

DESIGNER Takiro Yuta

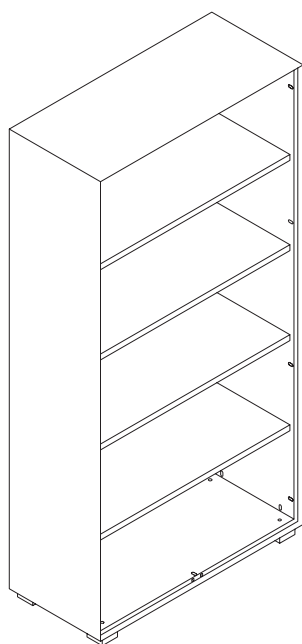

Front

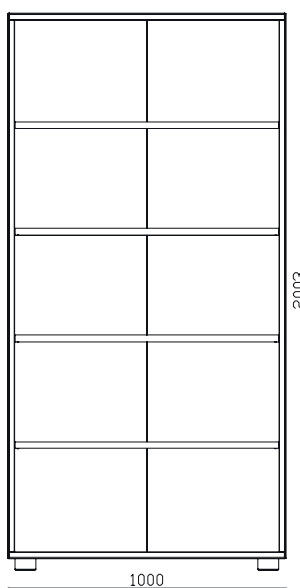

Side

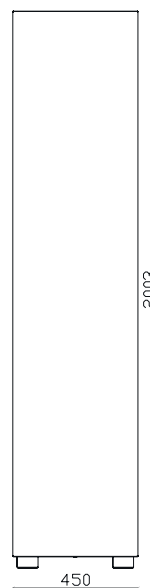

Back

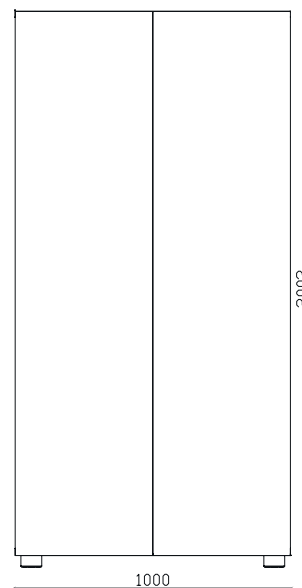

Primo Open Cabinets 1000

MADE IN ITALY

Open Cabinet
5 binder heights H 2003
W 1000 x D 450 x H 2003 mm

DESIGNER Takiro Yuta

DESCRIPTION	Open Cabinet 5 binder heights
EXTERNAL DIMENSIONS	W 1000 mm x D 450 mm x H 2003 mm
INTERNAL DIMENSIONS	W 951 x D 400 mm x H 1915 mm
BINDERS	Capacity: N° 11 (x5)
HANGING FILES	Capacity: 76 (x4) hanging files
PRODUCTION	<ul style="list-style-type: none"> > Dieffebi S.p.a. > Start of production: 2018 > Country of production: Italy
MAINTENANCE	<ul style="list-style-type: none"> > Clean with a soft cloth > Do not treat the surfaces with abrasive cloths
MATERIALS	> Structure made of recycled and recyclable metal
FINISHING	<ul style="list-style-type: none"> > Low-emission powder coating (material inert) > Heavy metals free > Absence of sharp edges > Anti-glare finish > It does not contain VOC
STANDARD COMPONENTS	<ul style="list-style-type: none"> > Height adjustable steel shelves with undershel filing > Shelf load capacity: 50 Kg > Adjustable feet H 40 mm > Assembly screws

COLORS	<ul style="list-style-type: none"> > Available in 3 standard colors: V1 White (RAL 9010) V6 Aluminium (RAL 9006) V22 Black (RAL 9005) > Standard semi-gloss colors > Customizable colors available upon request and with an extra charge: www.dieffebi.com/docs/299/2832/DFB_Colour-Chart-2020.pdf
ACCESSORIES	<ul style="list-style-type: none"> > Additional metal shelf > Clothes hanger > Plinth H 40mm > Single pullout and telescopic frame > Kit of 2 extractable and telescopic frames with full extension guides and selective extraction system (35Kg) > Kit for hanging files under top of cabinets > Hanging files for under cabinet shelves, length: 330 mm > Hanging files for under cabinet shelves, length: 390 mm > Set of 4 feet H 20mm > Set of 4 feet H 60 mm > possibility of assembling Primo series doors
NET WEIGHT	58,00 Kg
PACKAGING	<ul style="list-style-type: none"> > volume: 0,2 m³ > Plastic film in heat shrink > Cardboard corners and channel > Optimized for transport with CO2 reduction > Delivered: disassembled > Packages: 6
END OF USE	> Equipped with disassembly card for disposal
WARRANTY	> Dieffebi guarantees that the product was made using high quality materials - See warranty document

Primo Open Cabinets 1000

MADE IN ITALY

Open Cabinet
5 binder heights H 2003
W 1000 x D 450 x H 2003 mm

DESIGNER Takiro Yuta

WELLNESS AND ENVIRONMENT > Green design in accordance with LEED® standards, to design and furnish environments with a high sustainability content



STRUCTURE AND FINISH TEST Tests equivalent to the Primo Cabinets wardrobe series performed by CATAS
- declaration of conformity available on request

CLASS OF REACTION TO FIRE > Class 0

POSITIONING > Both on the wall and in the center of the room



ADIMEMBER



Dieffebi SpA

via Palù 36
San Vendemiano,
31020 Treviso - Italia

T +39 0438 4715
F +39 0438 471600
exportsales@dieffebi.com
vendite@dieffebi.com
www.dieffebi.com

Primo Open Cabinets 1000

Varnish Vernici Vernis Lacke

Cabinet Body
Corpo
Caisson
Korpus



-V1
S711 (RAL 9010)
Pure white



-V6
S380 (RAL 9006)
White aluminium



-V22
S811 (RAL 9005)
Jet black

Additional metal shelf
Ripiano aggiuntivo
in metallo
Tablette supplémentaire
en métal
Zusätzlicher
Metallfachboden

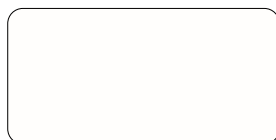

-V1
S711 (RAL 9010)
Pure white



-V6
S380 (RAL 9006)
White aluminium

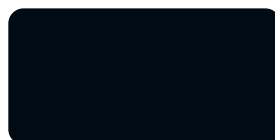

-V22
S811 (RAL 9005)
Jet black

Clothes hanger
Appendiabiti
Tringle
Kleiderstange



-V1
S711 (RAL 9010)
Pure white



-V6
S380 (RAL 9006)
White aluminium



-V22
S811 (RAL 9005)
Jet black

Plinth
Zoccolo
Socle
Sockel



-V1
S210 (RAL 7021)
Black grey

Kit for hanging files under top
of cabinets
Kit predisposizione cartelle
sospese sotto top
Jeu de rails pour dossier
suspendu sous plateau
Set Hängemappenrahmen
unter Platte



-V1
S711 (RAL 9010)
Pure white



-V6
S380 (RAL 9006)
White aluminium