

## Universal Mobile 320

MADE IN ITALY

Pedestal with 3 box drawers

W 320 mm x D 533 mm x H 555 mm

Body: metal

V1 ○ white RAL 9010

V6 ● aluminium RAL 9006

art. 9N550628R S711

art. 9N550628R S380

DESIGNER TAKIRO YUTA

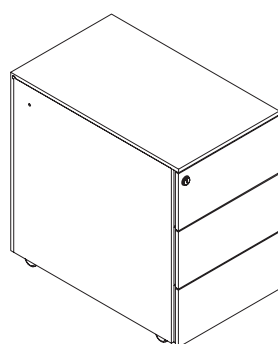

Front

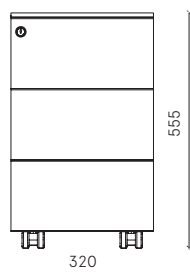

Side

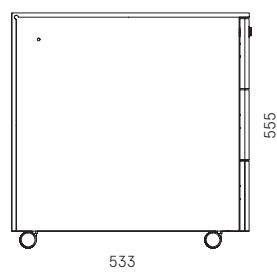

Back

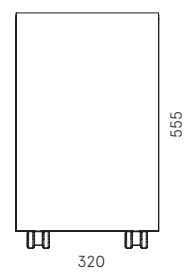

## Universal Mobile 320

MADE IN ITALY

Pedestal with 3 box drawers

W 320 mm x D 533 mm x H 555 mm

DESIGNER TAKIRO YUTA

<b>DESCRIPTION</b>	Pedestal with 3 box drawers	<b>COLORS</b>	<ul style="list-style-type: none"> <li>&gt; Available in 2 standard color:</li> <li>V1 white (RAL 9010)</li> <li>V6 aluminium (RAL 9006)</li> <li>&gt; Standard semi-gloss colors</li> <li>&gt; Customizable colors available upon request and with an extra charge:</li> <li><a href="http://www.dieffebi.com/docs/299/2832/DFB_Colour-Chart-2020.pdf">www.dieffebi.com/docs/299/2832/DFB_Colour-Chart-2020.pdf</a></li> </ul>
<b>EXTERNAL DIMENSIONS</b>	W 320 mm x D 533 mm x H 555 mm	<b>ACCESSORIES</b>	<ul style="list-style-type: none"> <li>&gt; Master key</li> <li>&gt; Cylinder extraction key</li> <li>&gt; Cylinder for keylock</li> <li>&gt; Pencil tray</li> <li>&gt; Soft closing mechanism</li> <li>&gt; Kit for anti-tilt device</li> <li>&gt; Set of 4 castors without brake</li> <li>&gt; Set of 4 castors, 2 with brake, 2 without brake</li> <li>&gt; Set of 4 rubber castors</li> </ul>
<b>INTERNAL DIMENSIONS</b>	<ul style="list-style-type: none"> <li>&gt; Drawer compartment:</li> <li>W 230 mm x D 483 mm x H 75 mm</li> <li>&gt; Maximum useful height H 110 mm</li> </ul>	<b>NET WEIGHT</b>	16,40 Kg
<b>PRODUCTION</b>	<ul style="list-style-type: none"> <li>&gt; Dieffebi S.p.a.</li> <li>&gt; Start of production: 2010</li> <li>&gt; Country of production: Italy</li> </ul>	<b>MAINTENANCE</b>	<ul style="list-style-type: none"> <li>&gt; Clean with a soft cloth</li> <li>&gt; Do not treat the surfaces with abrasive cloths</li> </ul>
<b>MATERIALS</b>	> Recycled and recyclable metal	<b>PACKAGING</b>	<ul style="list-style-type: none"> <li>&gt; volume: 0,123 m<sup>3</sup></li> <li>&gt; In recycled and recyclable cardboard box with 8 polystyrene protection corners</li> <li>&gt; Multiple on pallet</li> <li>&gt; Supplied assembled except for the castors</li> <li>&gt; Packages: 1</li> </ul>
<b>FINISHING</b>	<ul style="list-style-type: none"> <li>&gt; Powder painting after hot phosphodegreasing and fixing in ovens at 180 °;</li> <li>&gt; non-toxic, zero-emission paints;</li> <li>&gt; paint thickness: 80 microns</li> </ul>	<b>END OF USE</b>	> Equipped with disassembly card for disposal
<b>STANDARD COMPONENTS</b>	<ul style="list-style-type: none"> <li>&gt; Metal drawers</li> <li>&gt; Roller guide with partial extraction</li> <li>&gt; 50 mm diameter swivel castors</li> <li>&gt; Centralized locking</li> <li>&gt; Cylinder lock with 2 keys (fixed + foldable)</li> <li>&gt; Removable cylinder</li> </ul>	<b>WARRANTY</b>	> Dieffebi guarantees that the product was made using high quality materials - <a href="#">See warranty document</a>

## Universal Mobile 320

MADE IN ITALY

Pedestal with 3 box drawers

W 320 mm x D 533 mm x H 555 mm

DESIGNER TAKIRO YUTA

**WELLNESS AND ENVIRONMENT** > Green design in accordance with LEED® standards, to design and furnish environments with a high sustainability content



www.GreenTop.com



**STRUCTURE TEST** EN 14073-2/2004, par. 3.4  
 EN 14073-3/2004, par. 5.4  
 EN 14073-3/2004, par. 5.5  
 EN 14074/2004, par. 6.2.1  
 EN 14074/2004, par. 6.2.2  
 EN 14074/2004, par. 6.2.3  
 EN 14074/2004, par. 6.2.4  
 EN 14074/2004, par. 6.7  
 EN 16122/2012 + AC:2015, par.7.5.5

**FINISHING TEST** UNI EN ISO 2409:2013      EN ISO 1520:2006  
 NSS UNI EN ISO 9227:2017      UNI EN ISO 6272-1:2013  
 UNI EN 15187:2007      UNI EN 15185:2011  
 EN 12720:2013      UNI EN 15186:2012, met. B  
 EN 12721:2013      UNI 9300:2015  
 UNI 9429:2015

**CERTIFICATION** NF Environnement  
 Certifié par FCBA - Ameublement



**CLASS OF REACTION TO FIRE** > Class 0

**POSITIONING** > Free standing



MADE IN EUROPE



ASSUFFICIO  
 ASSOCIAZIONE FEDERLEGGIDARREDI

ADIMEMBER



consip  
 acquistinretepa.it

Dieffebi SpA

T +39 0438 4715  
 F +39 0438 471600  
 exportsales@dieffebi.com  
 vendite@dieffebi.com  
 www.dieffebi.com

## Universal Mobile 320

---

Varnish  
Vernici  
Vernis  
Lacke

---

Cabinet Body  
Corpo  
Caisson  
Korpus



**-V1**  
S711 (RAL 9010)  
Pure white



**-V6**  
S380 (RAL 9006)  
White aluminium

## Universal Mobile 320

MADE IN ITALY

Pedestal with 1 box drawer + 1 filing drawer

W 320 mm x D 533 mm x H 555 mm

Body: metal

V1 ○ white RAL 9010

V6 ● aluminium RAL 9006

art. 9N540628R S711

art. 9N540628R S380

DESIGNER TAKIRO YUTA

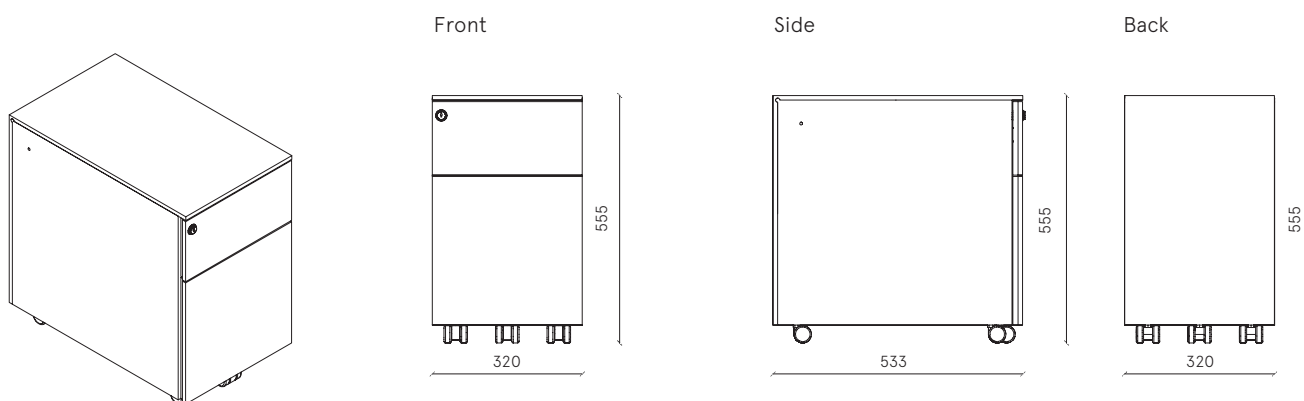

## Universal Mobile 320

MADE IN ITALY

Pedestal with 1 box drawer + 1 filing drawer

W 320 mm x D 533 mm x H 555 mm

DESIGNER TAKIRO YUTA

**DESCRIPTION** Pedestal with 1 box drawer + 1 filing drawer

**EXTERNAL DIMENSIONS** W 320 mm x D 533 mm x H 555 mm

**INTERNAL DIMENSIONS**

- > Drawer compartment: W 230 x D 483 x H 75 mm
- Maximum useful height H 110 mm
- > Filing compartment: W 225 x D 470 x H 238 mm
- Maximum useful height H 270 mm

**HANGING FILES** 18 x hanging files

**PRODUCTION**

- > Dieffebi S.p.a.
- > Start of production: 2010
- > Country of production: Italy

**MATERIALS** > Recycled and recyclable metal

**FINISHING**

- > Powder painting after hot phosphodegreasing and fixing in ovens at 180 °;
- > non-toxic, zero-emission paints;
- > paint thickness: 80 microns

**STANDARD COMPONENTS**

- > Metal drawers
- > Roller guide with partial extraction
- > Full extension ball guide on the filing cabinet
- > 50 mm diameter swivel castors
- > 5th anti-tip castor
- > Centralized locking
- > Cylinder lock with 2 keys (fixed + foldable)
- > Removable cylinder
- > 330/390 mm suspension file converter

**COLORS**

- > Available in 2 standard color:
- V1 white (RAL 9010)
- V6 aluminium (RAL 9006)
- > Standard semi-gloss colors
- > Customizable colors available upon request and with an extra charge:
- [www.dieffebi.com/docs/299/2832/DFB\\_Colour-Chart-2020.pdf](http://www.dieffebi.com/docs/299/2832/DFB_Colour-Chart-2020.pdf)

**ACCESSORIES**

- > Master key
- > Cylinder extraction key
- > Cylinder for keylock
- > Pencil tray
- > Soft closing (excluding the filing cabinet)
- > Kit for anti-tilt device
- > Hanging file 390 or 320 mm
- > 5th castor with bracket for castors
- > Set of 4 castors without brake
- > Set of 4 castors, 2 with brake, 2 without brake
- > Set of 4 rubber castors

**NET WEIGHT** 16,40 Kg

**MAINTENANCE**

- > Clean with a soft cloth
- > Do not treat the surfaces with abrasive cloths

**PACKAGING**

- > volume: 0,123 m<sup>3</sup>
- > In recycled and recyclable cardboard box with 8 polystyrene protection corners
- > Multiple on pallet
- > Supplied assembled except for the castors
- > Packages: 1

**END OF USE** > Equipped with disassembly card for disposal

**WARRANTY** > Dieffebi guarantees that the product was made using high quality materials - [See warranty document](#)

## Universal Mobile 320

MADE IN ITALY

Pedestal with 1 box drawer + 1 filing drawer

W 320 mm x D 533 mm x H 555 mm

DESIGNER TAKIRO YUTA

**WELLNESS AND ENVIRONMENT** > Green design in accordance with LEED® standards, to design and furnish environments with a high sustainability content



**STRUCTURE TEST** EN 14073-2/2004, par. 3.4  
 EN 14073-3/2004, par. 5.4  
 EN 14073-3/2004, par. 5.5  
 EN 14074/2004, par. 6.2.1  
 EN 14074/2004, par. 6.2.2  
 EN 14074/2004, par. 6.2.3  
 EN 14074/2004, par. 6.2.4  
 EN 14074/2004, par. 6.7  
 EN 16122/2012 + AC:2015, par.7.5.5

**FINISHING TEST** UNI EN ISO 2409:2013      EN ISO 1520:2006  
 NSS UNI EN ISO 9227:2017      UNI EN ISO 6272-1:2013  
 UNI EN 15187:2007      UNI EN 15185:2011  
 EN 12720:2013      UNI EN 15186:2012, met. B  
 EN 12721:2013      UNI 9300:2015  
 UNI 9429:2015

**CERTIFICATION** NF Environnement  
 Certifié par FCBA - Ameublement



**CLASS OF** > Class 0

**REACTION TO FIRE**

**POSITIONING** > Free standing



ADIMEMBER



## Universal Mobile 320

---

Varnish  
Vernici  
Vernis  
Lacke

---

Cabinet Body  
Corpo  
Caisson  
Korpus



**-V1**  
S711 (RAL 9010)  
Pure white



**-V6**  
S380 (RAL 9006)  
White aluminium



## Universal Mobile 420

MADE IN ITALY

Pedestal with 3 box drawers

W 420 mm x D 533 mm x H 555 mm

DESIGNER TAKIRO YUTA

Body: metal

- V1 ○ white RAL 9010  
 V6 ● aluminium RAL 9006  
 V2 ● silk grey RAL 7044  
 V22 ● black RAL 9005

art. 9N150612R S711  
 art. 9N150612R S380  
 art. 9N150612R 7044  
 art. 9N150612R S811

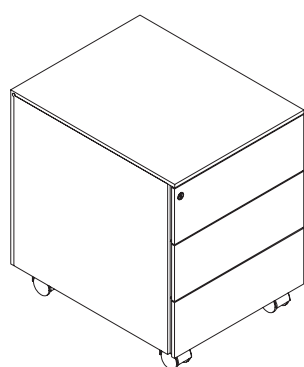

Front

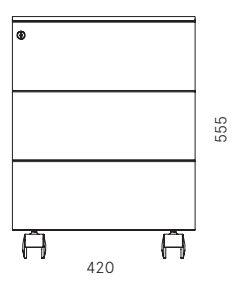

Side

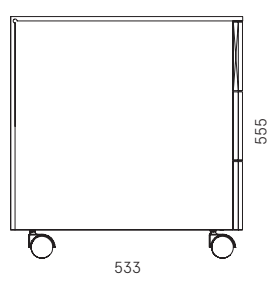

Back

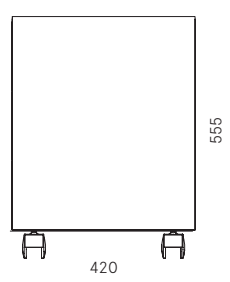

## Universal Mobile 420

MADE IN ITALY

Pedestal with 3 box drawers

W 420 mm x D 533 mm x H 555 mm

DESIGNER TAKIRO YUTA

<b>DESCRIPTION</b>	Pedestal with 3 box drawers	<b>COLORS</b>	<ul style="list-style-type: none"> <li>&gt; Available in 4 standard colors:</li> <li>V1 white (RAL 9010)</li> <li>V6 aluminium (RAL 9006)</li> <li>V2 silk grey (RAL 7036)</li> <li>V22 black (RAL 9005)</li> <li>&gt; Standard semi-gloss colors</li> <li>&gt; Customizable colors available upon request and with an extra charge:</li> <li><a href="http://www.dieffebi.com/docs/299/2832/DFB_Colour-Chart-2020.pdf">www.dieffebi.com/docs/299/2832/DFB_Colour-Chart-2020.pdf</a></li> </ul>
<b>EXTERNAL DIMENSIONS</b>	W 420 mm x D 533 mm x H 555 mm	<b>ACCESSORIES</b>	<ul style="list-style-type: none"> <li>&gt; Master key</li> <li>&gt; Cylinder extraction key</li> <li>&gt; Cylinder for keylock</li> <li>&gt; Set of 3 inclined dividers for box drawer</li> <li>&gt; Set of 3 vertical dividers for box drawer</li> <li>&gt; Kit for anti-tilt device</li> <li>&gt; Soft closing mechanism</li> <li>&gt; Pencil tray</li> <li>&gt; Reinforced fabric seat cushion</li> <li>&gt; Set of 4 castors without brake</li> <li>&gt; Set of 2 castors without brake</li> <li>&gt; Set of 4 castors, 2 with brake, 2 without brake</li> <li>&gt; Set of 4 rubber castors</li> </ul>
<b>INTERNAL DIMENSIONS</b>	<ul style="list-style-type: none"> <li>&gt; Drawer compartment: W 330 x D 483 x H 75 mm</li> <li>&gt; Maximum useful height: H 110 mm</li> </ul>	<b>NET WEIGHT</b>	17,92 Kg
<b>PRODUCTION</b>	<ul style="list-style-type: none"> <li>&gt; Dieffebi S.p.a.</li> <li>&gt; Start of production: 1995</li> <li>&gt; Country of production: Italy</li> </ul>	<b>MAINTENANCE</b>	<ul style="list-style-type: none"> <li>&gt; Clean with a soft cloth</li> <li>&gt; Do not treat the surfaces with abrasive cloths</li> </ul>
<b>MATERIALS</b>	> Recycled and recyclable metal	<b>PACKAGING</b>	<ul style="list-style-type: none"> <li>&gt; volume: 0,156 m<sup>3</sup></li> <li>&gt; In recycled and recyclable cardboard box with 8 polystyrene protection corners</li> <li>&gt; Multiple on pallet</li> <li>&gt; Supplied assembled except for the castors</li> <li>&gt; Packages: 1</li> </ul>
<b>FINISHING</b>	<ul style="list-style-type: none"> <li>&gt; Powder painting after hot phosphodegreasing and fixing in ovens at 180 °;</li> <li>&gt; non-toxic, zero-emission paints;</li> <li>&gt; paint thickness: 80 microns</li> </ul>	<b>END OF USE</b>	> Equipped with disassembly card for disposal
<b>STANDARD COMPONENTS</b>	<ul style="list-style-type: none"> <li>&gt; Metal drawers</li> <li>&gt; Roller guide with partial extraction</li> <li>&gt; 50 mm diameter swivel castors</li> <li>&gt; Centralized locking</li> <li>&gt; Cylinder lock with 2 keys (fixed + foldable)</li> <li>&gt; Removable cylinder</li> </ul>	<b>WARRANTY</b>	> Dieffebi guarantees that the product was made using high quality materials - <a href="#">See warranty document</a>

## Universal Mobile 420

MADE IN ITALY

Pedestal with 3 box drawers

W 420 mm x D 533 mm x H 555 mm

DESIGNER TAKIRO YUTA

**WELLNESS AND ENVIRONMENT** > Green design in accordance with LEED® standards, to design and furnish environments with a high sustainability content



www.GreenTop.com



**STRUCTURE TEST** EN 14073-2/2004, par. 3.4  
 EN 14073-3/2004, par. 5.4  
 EN 14073-3/2004, par. 5.5  
 EN 14074/2004, par. 6.2.1  
 EN 14074/2004, par. 6.2.2  
 EN 14074/2004, par. 6.2.3  
 EN 14074/2004, par. 6.7  
 EN 16122/2012 + AC:2015, par.7.5.5

**FINISHING TEST** UNI EN ISO 2409:2013      EN ISO 1520:2006  
 NSS UNI EN ISO 9227:2017      UNI EN ISO 6272-1:2013  
 UNI EN 15187:2007      UNI EN 15185:2011  
 EN 12720:2013      UNI EN 15186:2012, met. B  
 EN 12721:2013      UNI 9300:2015  
 UNI 9429:2015

**CERTIFICATION** NF Environnement  
 Certifié par FCBA - Ameublement



**CLASS OF** > Class 0

**REACTION TO FIRE**

**POSITIONING** > Free Standing



MADE IN EUROPE

ASSUFFICIO  
ASSOCIAZIONE FEDERLEGISLABBIO

ADIMEMBER



consip  
 acquistinretepa.it  
Il Fornitore Aggiunto della Pubblica Amministrazione

Dieffebi SpA

T +39 0438 4715  
 F +39 0438 471600  
 exportsales@dieffebi.com  
 vendite@dieffebi.com  
 www.dieffebi.com

## Universal Mobile 420

Varnish  
Vernici  
Vernis  
Lacke

Cabinet Body  
Corpo  
Caisson  
Korpus



-V1  
S711 (RAL 9010)  
Pure white



-V6  
S380 (RAL 9006)  
White aluminium



-V2  
7044 (RAL 7044)  
Silk grey

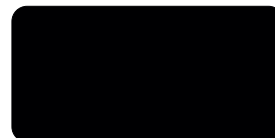

-V22  
S811 (RAL 9005)  
Jet black

Fabrics  
Tessuti  
Tissus  
Textilien

Reinforced fabric seat  
cushion  
Cuscino in tessuto con  
rinforzo  
Coussin en tissu  
renforcé  
Verstärktes Stoffkissen



-T3  
8009  
Jet, Fidivi

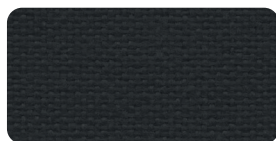

-T4  
8033  
Jet, Fidivi

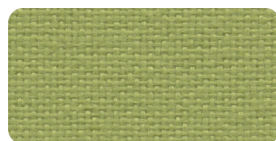

-T12  
7041  
Jet, Fidivi



-T7  
213  
Divina MD, Kvadrat

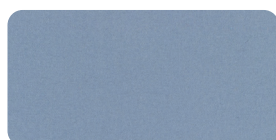

-T18  
701  
Hero, Kvadrat



-T24  
462  
Mirage, Pugi - PG



-T31  
133  
Mirage, Pugi - PG

## Universal Mobile 420





MADE IN ITALY

Pedestal with 1 box drawer and 1 filing drawer

W 420 mm x D 533 mm x H 555 mm

DESIGNER TAKIRO YUTA

Body: metal

- V1  white RAL 9010  
 V6  aluminium RAL 9006  
 V2  silk grey RAL 7044  
 V22  black RAL 9005

art. 9N140612R S711  
 art. 9N140612R S380  
 art. 9N140612R 7044  
 art. 9N140612R S811

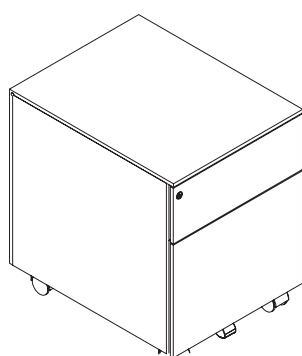

Front

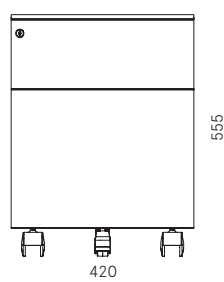

Side

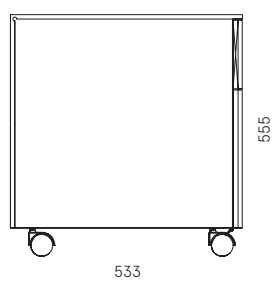

Back

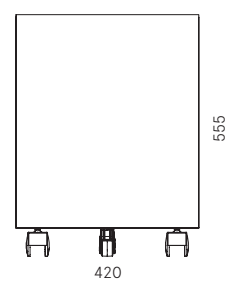

## Universal Mobile 420

MADE IN ITALY

Pedestal with 1 box drawer and 1 filing drawer

W 420 mm x D 533 mm x H 555 mm

DESIGNER TAKIRO YUTA

<b>DESCRIPTION</b>	Pedestal with 1 box drawer and 1 filing drawer	<b>COLORS</b>	<ul style="list-style-type: none"> <li>&gt; Available in 4 standard colors:</li> <li>V1 white (RAL 9010)</li> <li>V6 aluminium (RAL 9006)</li> <li>V2 silk grey (RAL 7036)</li> <li>V22 black (RAL 9005)</li> <li>&gt; Standard semi-gloss colors</li> <li>&gt; Customizable colors available upon request and with an extra charge:</li> <li><a href="http://www.dieffebi.com/docs/299/2832/DFB_Colour-Chart-2020.pdf">www.dieffebi.com/docs/299/2832/DFB_Colour-Chart-2020.pdf</a></li> </ul>
<b>EXTERNAL DIMENSIONS</b>	W 420 mm x D 533 mm x H 555 mm		
<b>INTERNAL DIMENSIONS</b>	<ul style="list-style-type: none"> <li>&gt; Drawer compartment: L 330 x P 483 x H 75 mm</li> <li>Maximum useful height: H 110 mm</li> <li>&gt; Filing compartment: L 325 x P 470 x H 238 mm</li> <li>Maximum useful height: H 270 mm</li> </ul>		
<b>HANGING FILES</b>	39 x 330 mm hanging files or 27 x 390 mm hanging files with the use of the dividing bar	<b>ACCESSORIES</b>	<ul style="list-style-type: none"> <li>&gt; Master key</li> <li>&gt; Cylinder extraction key</li> <li>&gt; Cylinder for keylock</li> <li>&gt; Division bar for filing cabinet</li> <li>&gt; Set of 3 inclined dividers for box drawer</li> <li>&gt; Set of 3 vertical dividers for box drawer</li> <li>&gt; Kit for anti-tilt device</li> <li>&gt; Soft closing mechanism</li> <li>&gt; Pencil tray</li> <li>&gt; 330 or 390 mm hanging files</li> <li>&gt; Reinforced fabric seat cushion</li> <li>&gt; Fifth castor with bracket for castors</li> <li>&gt; Set of 4 castors without brake</li> <li>&gt; Set of 2 castors without brake</li> <li>&gt; Set of 4 castors, 2 with brake, 2 without brake</li> <li>&gt; Set of 4 rubber castors</li> </ul>
<b>PRODUCTION</b>	<ul style="list-style-type: none"> <li>&gt; Dieffebi S.p.a.</li> <li>&gt; Start of production: 1995</li> <li>&gt; Country of production: Italy</li> </ul>		
<b>MATERIALS</b>	> Recycled and recyclable metal		
<b>FINISHING</b>	<ul style="list-style-type: none"> <li>&gt; Powder painting after hot phosphodegreasing and fixing in ovens at 180 °;</li> <li>&gt; non-toxic, zero-emission paints;</li> <li>&gt; paint thickness: 80 microns</li> </ul>		
<b>MAINTENANCE</b>	<ul style="list-style-type: none"> <li>&gt; Clean with a soft cloth</li> <li>&gt; Do not treat the surfaces with abrasive cloths</li> </ul>		
<b>STANDARD COMPONENTS</b>	<ul style="list-style-type: none"> <li>&gt; Metal drawers</li> <li>&gt; Roller guide with partial extraction</li> <li>&gt; Full extension ball guide on the filing cabinet</li> <li>&gt; 50 mm diameter swivel castors</li> <li>&gt; Fifth castor with bracket for castors</li> <li>&gt; Centralized locking</li> <li>&gt; Cylinder lock with 2 keys (fixed + foldable)</li> <li>&gt; Removable cylinder</li> </ul>	<b>NET WEIGHT</b>	18,06 Kg
		<b>PACKAGING</b>	<ul style="list-style-type: none"> <li>&gt; volume: 0,156 m<sup>3</sup></li> <li>&gt; In recycled and recyclable cardboard box with 8 polystyrene protection corners</li> <li>&gt; Multiple on pallet</li> <li>&gt; Supplied assembled except for the castors</li> <li>&gt; Packages: 1</li> </ul>
		<b>END OF USE</b>	> Equipped with disassembly card for disposal
		<b>WARRANTY</b>	> Dieffebi guarantees that the product was made using high quality materials - <a href="#">See warranty document</a>

## Universal Mobile 420

MADE IN ITALY

Pedestal with 1 box drawer and 1 filing drawer

W 420 mm x D 533 mm x H 555 mm

DESIGNER TAKIRO YUTA

**WELLNESS AND ENVIRONMENT** > Green design in accordance with LEED® standards, to design and furnish environments with a high sustainability content



**STRUCTURE TEST** EN 14073-2/2004, par. 3.4  
 EN 14073-3/2004, par. 5.4  
 EN 14073-3/2004, par. 5.5  
 EN 14074/2004, par. 6.2.1  
 EN 14074/2004, par. 6.2.2  
 EN 14074/2004, par. 6.2.3  
 EN 14074/2004, par. 6.7  
 EN 16122/2012 + AC:2015, par.7.5.5

<b>FINISHING TEST</b>	UNI EN ISO 2409:2013	EN ISO 1520:2006
	NSS UNI EN ISO 9227:2017	UNI EN ISO 6272-1:2013
	UNI EN 15187:2007	UNI EN 15185:2011
	EN 12720:2013	UNI EN 15186:2012, met. B
	EN 12721:2013	UNI 9300:2015
	UNI 9429:2015	

**CERTIFICATION** NF Environnement  
 Ceritifié par FCBA - Ameublement



**CLASS OF REACTION TO FIRE** > Class 0

**POSITIONING** > Free Standing



ADIMEMBER



Dieffebi SpA

T +39 0438 4715  
 F +39 0438 471600  
 exportsales@dieffebi.com  
 vendite@dieffebi.com  
 www.dieffebi.com



## Universal Mobile 420

Varnish  
Vernici  
Vernis  
Lacke

Cabinet Body  
Corpo  
Caisson  
Korpus

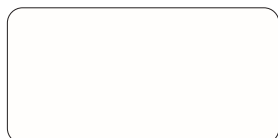

**-V1**  
S711 (RAL 9010)  
Pure white



**-V6**  
S380 (RAL 9006)  
White aluminium



**-V2**  
7044 (RAL 7044)  
Silk grey

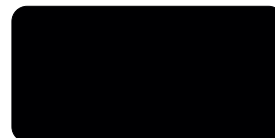

**-V22**  
S811 (RAL 9005)  
Jet black

Fabrics  
Tessuti  
Tissus  
Textilien

Reinforced fabric seat  
cushion  
Cuscino in tessuto con  
rinforzo  
Cousin en tissu  
renforcé  
Verstärktes Stoffkissen



**-T3**  
8009  
Jet, Fidivi

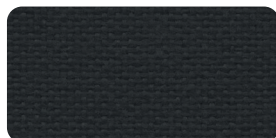

**-T4**  
8033  
Jet, Fidivi

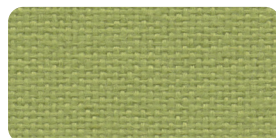

**-T12**  
7041  
Jet, Fidivi



**-T7**  
213  
Divina MD, Kvadrat

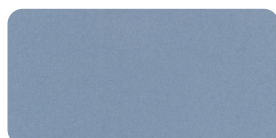

**-T18**  
701  
Hero, Kvadrat

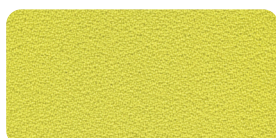

**-T24**  
462  
Mirage, Pugi - PG



**-T31**  
133  
Mirage, Pugi - PG



## Universal Mobile 420

MADE IN ITALY

Pedestal with 1 box drawer and 1 stationery drawer

W 420 mm x D 533 mm x H 555 mm

DESIGNER TAKIRO YUTA

Body: metal

- V1 ○ white RAL 9010  
 V6 ● aluminium RAL 9006  
 V2 ● silk grey RAL 7044  
 V22 ● black RAL 9005

art. 9N180612R S711  
 art. 9N180612R S380  
 art. 9N180612R 7044  
 art. 9N180612R S811

Front

Side

Back

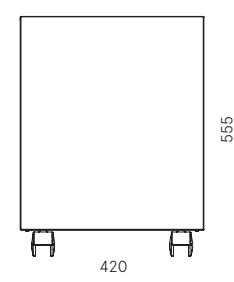
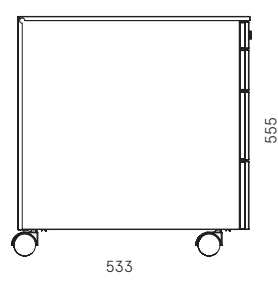
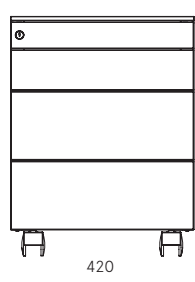
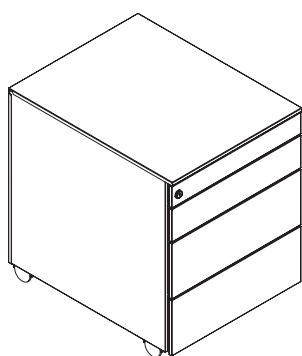

## Universal Mobile 420

MADE IN ITALY

Pedestal with 1 box drawer and 1 stationery drawer

W 420 mm x D 533 mm x H 555 mm

DESIGNER TAKIRO YUTA

<b>DESCRIPTION</b>	Pedestal with 1 box drawer and 1 stationery drawer	<b>COLORS</b>	<ul style="list-style-type: none"> <li>&gt; Available in 4 standard colors:</li> <li>V1 white (RAL 9010)</li> <li>V6 aluminium (RAL 9006)</li> <li>V2 silk grey (RAL 7036)</li> <li>V22 black (RAL 9005)</li> <li>&gt; Standard semi-gloss colors</li> <li>&gt; Customizable colors available upon request and with an extra charge:</li> <li><a href="http://www.dieffebi.com/docs/299/2832/DFB_Colour-Chart-2020.pdf">www.dieffebi.com/docs/299/2832/DFB_Colour-Chart-2020.pdf</a></li> </ul>
<b>EXTERNAL DIMENSIONS</b>	W 420 mm x D 533 mm x H 555 mm		
<b>INTERNAL DIMENSIONS</b>	<ul style="list-style-type: none"> <li>&gt; Drawer compartment: L 330 x P 483 x H 75 mm</li> <li>&gt; Intermediate drawer: maximum useful height H 86 mm</li> <li>&gt; 2 lower drawers: maximum useful height H 110 mm</li> </ul>		
<b>PRODUCTION</b>	<ul style="list-style-type: none"> <li>&gt; Dieffebi S.p.a.</li> <li>&gt; Start of production: 1995</li> <li>&gt; Country of production: Italy</li> </ul>	<b>ACCESSORIES</b>	<ul style="list-style-type: none"> <li>&gt; Master key</li> <li>&gt; Cylinder extraction key</li> <li>&gt; Cylinder for keylock</li> <li>&gt; Set of 3 inclined dividers for box drawer</li> <li>&gt; Set of 3 vertical dividers for box drawer</li> <li>&gt; Kit for anti-tilt device</li> <li>&gt; Soft closing mechanism</li> <li>&gt; Pencil tray</li> <li>&gt; Pencil tray for stationery drawer</li> <li>&gt; Reinforced fabric seat cushion</li> <li>&gt; Set of 4 castors without brake</li> <li>&gt; Set of 2 castors without brake</li> <li>&gt; Set of 4 castors, 2 with brake, 2 without brake</li> <li>&gt; Set of 4 rubber castors</li> </ul>
<b>MATERIALS</b>	> Recycled and recyclable metal		
<b>FINISHING</b>	<ul style="list-style-type: none"> <li>&gt; Powder painting after hot phosphodegreasing and fixing in ovens at 180 °;</li> <li>&gt; non-toxic, zero-emission paints;</li> <li>&gt; paint thickness: 80 microns</li> </ul>		
<b>MAINTENANCE</b>	<ul style="list-style-type: none"> <li>&gt; Clean with a soft cloth</li> <li>&gt; Do not treat the surfaces with abrasive cloths</li> </ul>		
<b>STANDARD COMPONENTS</b>	<ul style="list-style-type: none"> <li>&gt; Metal drawers</li> <li>&gt; Roller guide with partial extraction</li> <li>&gt; 50 mm diameter swivel wheels</li> <li>&gt; Centralized locking</li> <li>&gt; Cylinder lock with 2 keys (fixed + foldable)</li> <li>&gt; Removable cylinder</li> </ul>	<b>NET WEIGHT</b>	20,09 Kg
		<b>PACKAGING</b>	<ul style="list-style-type: none"> <li>&gt; volume: 0,156 m<sup>3</sup></li> <li>&gt; In recycled and recyclable cardboard box with 8 polystyrene protection corners</li> <li>&gt; Multiple on pallet</li> <li>&gt; Supplied assembled except for the castors</li> <li>&gt; Packages: 1</li> </ul>
		<b>END OF USE</b>	> Equipped with disassembly card for disposal
		<b>WARRANTY</b>	> Dieffebi guarantees that the product was made using high quality materials - <a href="#">See warranty document</a>

## Universal Mobile 420

MADE IN ITALY

Pedestal with 1 box drawer and 1 stationery drawer

W 420 mm x D 533 mm x H 555 mm

DESIGNER TAKIRO YUTA

**WELLNESS AND ENVIRONMENT** > Green design in accordance with LEED® standards, to design and furnish environments with a high sustainability content



**STRUCTURE TEST** EN 14073-2/2004, par. 3.4  
 EN 14073-3/2004, par. 5.4  
 EN 14073-3/2004, par. 5.5  
 EN 14074/2004, par. 6.2.1  
 EN 14074/2004, par. 6.2.2  
 EN 14074/2004, par. 6.2.3  
 EN 14074/2004, par. 6.7  
 EN 16122/2012 + AC:2015, par.7.5.5

**FINISHING TEST** UNI EN ISO 2409:2013      EN ISO 1520:2006  
 NSS UNI EN ISO 9227:2017      UNI EN ISO 6272-1:2013  
 UNI EN 15187:2007      UNI EN 15185:2011  
 EN 12720:2013      UNI EN 15186:2012, met. B  
 EN 12721:2013      UNI 9300:2015  
 UNI 9429:2015

**CERTIFICATION** NF Environnement  
 Ceritifié par FCBA - Ameublement



**CLASS OF** > Class 0

**REACTION TO FIRE**

**POSITIONING** > Free Standing



ADIMEMBER



## Universal Mobile 420

Varnish  
Vernici  
Vernis  
Lacke

Cabinet Body  
Corpo  
Caisson  
Korpus



-V1  
S711 (RAL 9010)  
Pure white



-V6  
S380 (RAL 9006)  
White aluminium



-V2  
7044 (RAL 7044)  
Silk grey

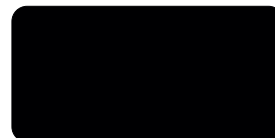

-V22  
S811 (RAL 9005)  
Jet black

Fabrics  
Tessuti  
Tissus  
Textilien

Reinforced fabric seat  
cushion  
Cuscino in tessuto con  
rinforzo  
Coussin en tissu  
renforcé  
Verstärktes Stoffkissen



-T3  
8009  
Jet, Fidivi

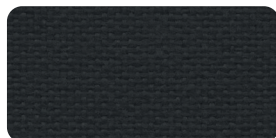

-T4  
8033  
Jet, Fidivi



-T12  
7041  
Jet, Fidivi



-T7  
213  
Divina MD, Kvadrat

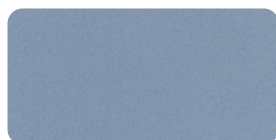

-T18  
701  
Hero, Kvadrat



-T24  
462  
Mirage, Pugi - PG



-T31  
133  
Mirage, Pugi - PG

## Universal Mobile 420

MADE IN ITALY

Pedestal with 1 box, 1 file and 1 stationary drawer

W 420 mm x D 533 mm x H 555 mm

Body: metal

- V1 ○ white RAL 9010  
 V6 ● aluminium RAL 9006  
 V2 ● silk grey RAL 7044  
 V22 ● black RAL 9005

art. 9N170612R S711  
 art. 9N170612R S380  
 art. 9N170612R 7044  
 art. 9N170612R S811

DESIGNER TAKIRO YUTA

Front

Side

Back

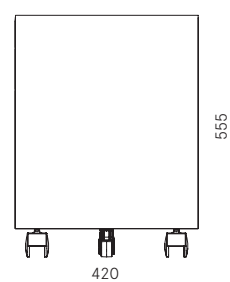
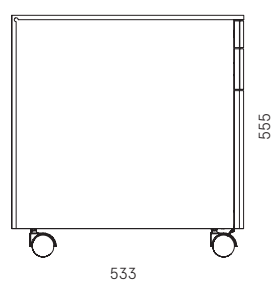
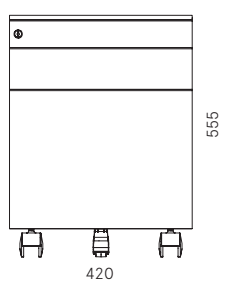
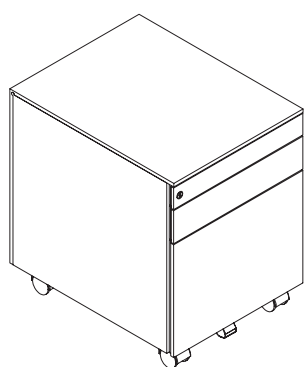

## Universal Mobile 420

MADE IN ITALY

Pedestal with 1 box , 1 file and 1 stationery drawer

W 420 mm x D 533 mm x H 555 mm

DESIGNER TAKIRO YUTA

<b>DESCRIPTION</b>	Pedestal with 1 box , 1 file and 1 stationery drawer	<b>COLORS</b>	<ul style="list-style-type: none"> <li>&gt; Available in 4 standard colors:</li> <li>V1 white (RAL 9010)</li> <li>V6 aluminium (RAL 9006)</li> <li>V2 silk grey (RAL 7036)</li> <li>V22 black (RAL 9005)</li> <li>&gt; Standard semi-gloss colors</li> <li>&gt; Customizable colors available upon request and with an extra charge:</li> <li><a href="http://www.dieffebi.com/docs/299/2832/DFB_Colour-Chart-2020.pdf">www.dieffebi.com/docs/299/2832/DFB_Colour-Chart-2020.pdf</a></li> </ul>
<b>EXTERNAL DIMENSIONS</b>	L 420 mm x P 533 mm x H 555 mm	<b>ACCESSORIES</b>	<ul style="list-style-type: none"> <li>&gt; Master key</li> <li>&gt; Cylinder extraction key</li> <li>&gt; Cylinder for keylock</li> <li>&gt; Division bar for filing cabinet</li> <li>&gt; Set of 3 inclined dividers for box drawer</li> <li>&gt; Set of 3 vertical dividers for box drawer</li> <li>&gt; Kit for anti-tilt device</li> <li>&gt; Soft closing mechanism</li> <li>&gt; Pencil tray</li> <li>&gt; Pencil tray for stationery drawer</li> <li>&gt; 330 or 390 mm hanging files</li> <li>&gt; Reinforced fabric seat cushion</li> <li>&gt; Fifth castor with bracket for castors</li> <li>&gt; Set of 4 castors without brake</li> <li>&gt; Set of 2 castors without brake</li> <li>&gt; Set of 4 castors, 2 with brake, 2 without brake</li> <li>&gt; Set of 4 rubber castors</li> </ul>
<b>INTERNAL DIMENSIONS</b>	<p>Vano cassetto: L 330 x P 483 x H 75 mm</p> <ul style="list-style-type: none"> <li>&gt; Altezza massima utile H 86 mm</li> </ul> <p>Vano classificatore: L 325 x P 470 x H 238 mm</p> <ul style="list-style-type: none"> <li>&gt; Altezza massima utile H 270 mm</li> </ul> <p>Vano cancelleria: L 332 x P 486 x H 39 mm</p>	<b>NET WEIGHT</b>	20,23 Kg
<b>HANGING FILES</b>	39 x 330 mm hanging files or 27 x 390 mm hanging files with the use of the dividing bar	<b>PACKAGING</b>	<ul style="list-style-type: none"> <li>&gt; volume: 0,156 m<sup>3</sup></li> <li>&gt; In recycled and recyclable cardboard box with 8 polystyrene protection corners</li> <li>&gt; Multiple on pallet</li> <li>&gt; Supplied assembled except for the castors</li> <li>&gt; Packages: 1</li> </ul>
<b>PRODUCTION</b>	<ul style="list-style-type: none"> <li>&gt; Dieffebi S.p.a.</li> <li>&gt; Start of production: 1995</li> <li>&gt; Country of production: Italy</li> </ul>	<b>END OF USE</b>	> Equipped with disassembly card for disposal
<b>MATERIALS</b>	> Recycled and recyclable metal	<b>WARRANTY</b>	> Dieffebi guarantees that the product was made using high quality materials - <a href="#">See warranty document</a>
<b>FINISHING</b>	<ul style="list-style-type: none"> <li>&gt; Powder painting after hot phosphodegreasing and fixing in ovens at 180 °;</li> <li>&gt; non-toxic, zero-emission paints;</li> <li>&gt; paint thickness: 80 microns</li> </ul>		
<b>MAINTENANCE</b>	<ul style="list-style-type: none"> <li>&gt; Clean with a soft cloth</li> <li>&gt; Do not treat the surfaces with abrasive cloths</li> </ul>		
<b>STANDARD COMPONENTS</b>	<ul style="list-style-type: none"> <li>&gt; Metal drawers</li> <li>&gt; Roller guide with partial extraction</li> <li>&gt; Full extension ball guide on the filing cabinet</li> <li>&gt; 50 mm diameter swivel castors</li> <li>&gt; Fifth castor with bracket for castors</li> <li>&gt; Centralized locking</li> <li>&gt; Cylinder lock with 2 keys (fixed + foldable)</li> <li>&gt; Removable cylinder</li> </ul>		

## Universal Mobile 420

MADE IN ITALY

Pedestal with 1 box , 1 file and 1 stationery drawer

W 420 mm x D 533 mm x H 555 mm

DESIGNER TAKIRO YUTA

**WELLNESS AND ENVIRONMENT** > Green design in accordance with LEED® standards, to design and furnish environments with a high sustainability content



www.GreenTop.com



**STRUCTURE TEST** EN 14073-2/2004, par. 3.4  
 EN 14073-3/2004, par. 5.4  
 EN 14073-3/2004, par. 5.5  
 EN 14074/2004, par. 6.2.1  
 EN 14074/2004, par. 6.2.2  
 EN 14074/2004, par. 6.2.3  
 EN 14074/2004, par. 6.7  
 EN 16122/2012 + AC:2015, par.7.5.5

**FINISHING TEST** UNI EN ISO 2409:2013      EN ISO 1520:2006  
 NSS UNI EN ISO 9227:2017      UNI EN ISO 6272-1:2013  
 UNI EN 15187:2007      UNI EN 15185:2011  
 EN 12720:2013      UNI EN 15186:2012, met. B  
 EN 12721:2013      UNI 9300:2015  
 UNI 9429:2015

**CERTIFICATION** NF Environnement  
 Certifié par FCBA - Ameublement



**CLASS OF** > Class 0

**REACTION TO FIRE**

**POSITIONING** > Free Standing



dieffebi



MADE IN EUROPE



ASSUFFICIO  
 ASSOCIAZIONE FEDERLEASINGARREDO

ADIMEMBER



consip  
 acquistinretepa.it  
 Il Fornitore Ufficiale del Settore Pubblico

Dieffebi SpA

via Palù 36  
 San Vendemiano,  
 31020 Treviso - Italia

T +39 0438 4715  
 F +39 0438 471600  
 exportsales@dieffebi.com  
 vendite@dieffebi.com  
 www.dieffebi.com



## Universal Mobile 420

Varnish  
Vernici  
Vernis  
Lacke

Cabinet Body  
Corpo  
Caisson  
Korpus

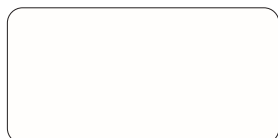

**-V1**  
S711 (RAL 9010)  
Pure white



**-V6**  
S380 (RAL 9006)  
White aluminium



**-V2**  
7044 (RAL 7044)  
Silk grey

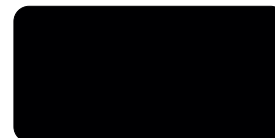

**-V22**  
S811 (RAL 9005)  
Jet black

Fabrics  
Tessuti  
Tissus  
Textilien

Reinforced fabric seat  
cushion  
Cuscino in tessuto con  
rinforzo  
Coussin en tissu  
renforcé  
Verstärktes Stoffkissen



**-T3**  
8009  
Jet, Fidivi

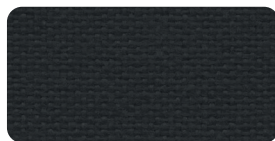

**-T4**  
8033  
Jet, Fidivi

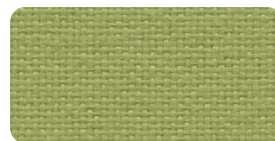

**-T12**  
7041  
Jet, Fidivi



**-T7**  
213  
Divina MD, Kvadrat

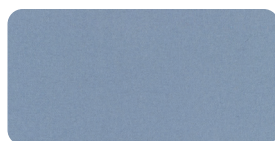

**-T18**  
701  
Hero, Kvadrat



**-T24**  
462  
Mirage, Pugi - PG



**-T31**  
133  
Mirage, Pugi - PG