

Universal Mobile 320

MADE IN ITALY

Cassettiera a 3 cassetti

L 320 mm x P 533 mm x H 555 mm

Struttura: metallo

V1 ○ bianco RAL 9010

V6 ● alluminio RAL 9006

art. 9N550628R S711

art. 9N550628R S380

DESIGNER TAKIRO YUTA

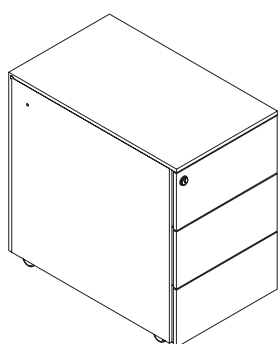

Fronte

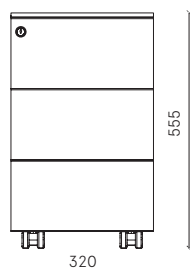

Fianco

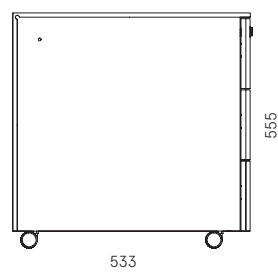

Retro

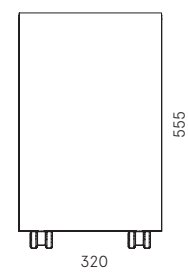

Universal Mobile 320

MADE IN ITALY

Cassettiera a 3 cassette

L 320 mm x P 533 mm x H 555 mm

DESIGNER TAKIRO YUTA

DESCRIZIONE	Cassettiera a 3 cassette	COLORI	> Struttura: disponibile in 2 colori standard V1 bianco (RAL 9010) V6 alluminio (RAL 9006) > Colori standard semilucidi > Colori personalizzabili su richiesta previa disponibilità e con sovrapprezzo: www.dieffebi.com/docs/299/2832/DFB_Colour-Chart-2020.pdf
DIMENSIONI ESTERNE	L 320 mm x P 533 mm x H 555 mm		
DIMENSIONI INTERNE	Vano cassetto: L 230 mm x P 483 mm x H 75 mm > Altezza massima utile H 110 mm		
PRODUZIONE	> Dieffebi S.p.a. > Inizio produzione: anno 2010 > Luogo di produzione: Italia	ACCESSORI	> Chiave master > Chiave per estrazione cilindro > Cilindro per serratura > Vaschetta portamatite > Chiusura ammortizzata > Confezione per sistema antiribaltamento > Set 4 ruote senza freno > Set 4 ruote, 2 con freno, 2 senza freno > Set 4 ruote gommate
MATERIALI	> struttura in metallo riciclato e riciclabile		
FINITURA	> Verniciatura a polveri previo fosfosgrassaggio a caldo e fissaggio in forni a 180°; > vernici atossiche a zero emissioni; > spessore vernici: 80 micron	PESO NETTO	16,40 Kg
COMPONENTI STANDARD	> Cassetti in metallo > Guida a rullo ad estrazione parziale > Ruote piroettanti diam. 50 mm > Chiusura centralizzata > Serratura con 2 chiavi (fissa + pieghevole) > Cilindro estraibile	MANUTENZIONE	> Pulire con panno morbido > Non trattare le superfici con panni abrasivi
		IMBALLO	> volume: 0,123 m ³ > In scatola di cartone riciclato e riciclabile con 8 angolari in polistirolo di protezione > Multiplo su pallet > Fornito montato ad esclusione delle ruote > N°colli: 1
		END OF USE	> Corredato di scheda di disassemblaggio per smaltimento.
		GARANZIA	> Dieffebi garantisce che il prodotto è stato realizzato usando materiali di alta qualità - Vedi documento di garanzia.

Universal Mobile 320

MADE IN ITALY

Cassettiera a 3 cassette

L 320 mm x P 533 mm x H 555 mm

DESIGNER TAKIRO YUTA

BENESSERE E AMBIENTE > Design "green" in accordo con gli standard LEED®, per progettare ed arredare ambienti ad alto contenuto di sostenibilità.



TEST STRUTTURA EN 14073-2/2004, par. 3.4
 EN 14073-3/2004, par. 5.4
 EN 14073-3/2004, par. 5.5
 EN 14074/2004, par. 6.2.1
 EN 14074/2004, par. 6.2.2
 EN 14074/2004, par. 6.2.3
 EN 14074/2004, par. 6.2.4
 EN 14074/2004, par. 6.7
 EN 16122/2012 + AC:2015, par.7.5.5

TEST FINITURA UNI EN ISO 2409:2013 EN ISO 1520:2006
 NSS UNI EN ISO 9227:2017 UNI EN ISO 6272-1:2013
 UNI EN 15187:2007 UNI EN 15185:2011
 EN 12720:2013 UNI EN 15186:2012, met. B
 EN 12721:2013 UNI 9300:2015
 UNI 9429:2015

CERTIFICAZIONE NF Environnement
 Certifié par FCBA - Ameublement



CLASSE DI > Classe 0

REAZIONE AL FUOCO

POSIZIONAMENTO > Free standing



ADIMEMBER



Dieffebi SpA

T +39 0438 4715
 F +39 0438 471600
 exportsales@dieffebi.com
 vendite@dieffebi.com
 www.dieffebi.com

Universal Mobile 320

Vernici
Varnish
Vernis
Lacke

Corpo
Cabinet Body
Caisson
Korpus



-V1
S711 (RAL 9010)
Pure white



-V6
S380 (RAL 9006)
White aluminium

Universal Mobile 320

MADE IN ITALY

Cassettiera 1 cassetto + 1 cassetto classificatore

Struttura: metallo

V1 ○ bianco RAL 9010

art. 9N540628R S711

L 320 mm x P 533 mm x H 555 mm

V6 ● alluminio RAL 9006

art. 9N540628R S380

DESIGNER TAKIRO YUTA

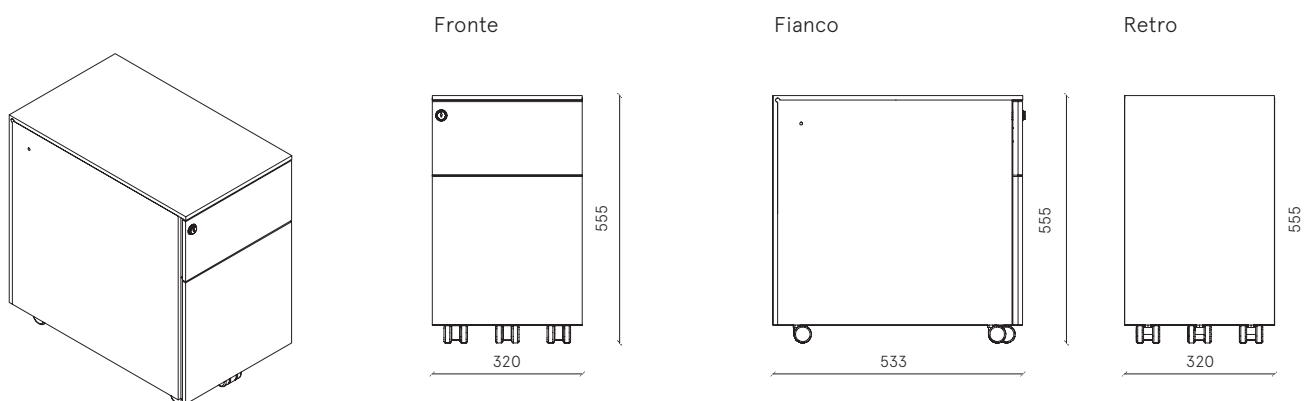

Universal Mobile 320

MADE IN ITALY

Cassettiera 1 cassetto + 1 cassetto classificatore

L 320 mm x P 533 mm x H 555 mm

DESIGNER TAKIRO YUTA

DESCRIZIONE	Cassettiera 1 cassetto + 1 cassetto classificatore	COLORI	<ul style="list-style-type: none"> > Struttura: disponibile in 2 colori standard V1 bianco (RAL 9010) V6 alluminio (RAL 9006) > Colori standard semilucidi > Colori personalizzabili su richiesta previa disponibilità e con sovrapprezzo: www.dieffebi.com/docs/299/2832/DFB_Colour-Chart-2020.pdf
DIMENSIONI ESTERNE	L 320 mm x P 533 mm x H 555 mm	ACCESSORI	<ul style="list-style-type: none"> > Chiave master > Chiave per estrazione cilindro > Cilindro per serratura > Vaschetta portamatite > Chiusura ammortizzata (escluso il classificatore) > Confezione per sistema antiribaltamento > Cartellina sospesa da 390 o 320 mm > 5° rotellina con staffa per ruote > Set 4 ruote senza freno > Set 4 ruote, 2 con freno, 2 senza freno > Set 4 ruote gommate
DIMENSIONI INTERNE	<ul style="list-style-type: none"> > Vano cassetto: L 230 x P 483 x H 75 mm Altezza massima utile H 110 mm > Vano classificatore: L 225 x P 470 x H 238 mm Altezza massima utile H 270 mm 	PESO NETTO	16,40 Kg
CARTELLINE	N° 18 cartelline	MANUTENZIONE	<ul style="list-style-type: none"> > Pulire con panno morbido > Non trattare le superfici con panni abrasivi
PRODUZIONE	<ul style="list-style-type: none"> > Dieffebi S.p.a. > Inizio produzione: anno 2010 > Luogo di produzione: Italia 	IMBALLO	<ul style="list-style-type: none"> > volume: 0,123 m³ > In scatola di cartone riciclato e riciclabile con 8 angolari in polistirolo di protezione > Multiplo su pallet > Fornito montato ad esclusione delle ruote > N°colli: 1
MATERIALI	> struttura in metallo riciclato e riciclabile	END OF USE	> Corredato di scheda di disassemblaggio per smaltimento.
FINITURA	<ul style="list-style-type: none"> > Verniciatura a polveri previo fosfosgrassaggio a caldo e fissaggio in forni a 180°; > vernici atossiche a zero emissioni; > spessore vernici: 80 micron 	GARANZIA	> Dieffebi garantisce che il prodotto è stato realizzato usando materiali di alta qualità - Vedi documento di garanzia.
COMPONENTI STANDARD	<ul style="list-style-type: none"> > Cassetti in metallo > Guida a rullo ad estrazione parziale > Guida a sfera ad estrazione totale sul classificatore > Ruote piroettanti diam. 50 mm > 5^ ruota antiribaltamento > Chiusura centralizzata > Serratura con 2 chiavi (fissa+pieghevole) > Cilindro estraibile > Convertitore per cartelle sospese da 330/390 mm 		

Universal Mobile 320

MADE IN ITALY

Cassettiera 1 cassetto + 1 cassetto classificatore

L 320 mm x P 533 mm x H 555 mm

DESIGNER TAKIRO YUTA

BENESSERE E AMBIENTE > Design "green" in accordo con gli standard LEED®, per progettare ed arredare ambienti ad alto contenuto di sostenibilità.



TEST STRUTTURA EN 14073-2/2004, par. 3.4
 EN 14073-3/2004, par. 5.4
 EN 14073-3/2004, par. 5.5
 EN 14074/2004, par. 6.2.1
 EN 14074/2004, par. 6.2.2
 EN 14074/2004, par. 6.2.3
 EN 14074/2004, par. 6.2.4
 EN 14074/2004, par. 6.7
 EN 16122/2012 + AC:2015, par.7.5.5

TEST FINITURA UNI EN ISO 2409:2013 EN ISO 1520:2006
 NSS UNI EN ISO 9227:2017 UNI EN ISO 6272-1:2013
 UNI EN 15187:2007 UNI EN 15185:2011
 EN 12720:2013 UNI EN 15186:2012, met. B
 EN 12721:2013 UNI 9300:2015
 UNI 9429:2015

CERTIFICAZIONE NF Environnement
 Certifié par FCBA - Ameublement



CLASSE DI > Classe 0

REAZIONE AL FUOCO

POSIZIONAMENTO > Free standing



ADIMEMBER



Universal Mobile 320

Vernici
Varnish
Vernis
Lacke

Corpo
Cabinet Body
Caisson
Korpus



-V1
S711 (RAL 9010)
Pure white



-V6
S380 (RAL 9006)
White aluminium

Universal Mobile 420

MADE IN ITALY

Cassettiera 3 cassetti

L 420 mm x P 533 mm x H 555 mm

DESIGNER TAKIRO YUTA

Struttura: metallo

V1 ○ bianco RAL 9010

V6 ● alluminio RAL 9006

V2 ● grigio tortora RAL 7044

V22 ● nero RAL 9005

art. 9N150612R S711

art. 9N150612R S380

art. 9N150612R 7044

art. 9N150612R S811

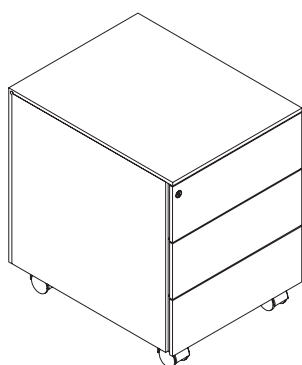

Fronte

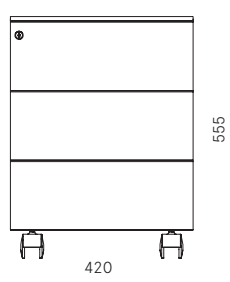

Fianco

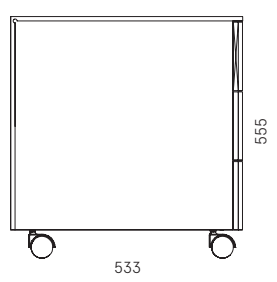

Retro

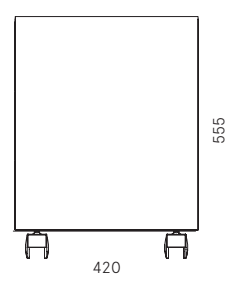

Universal Mobile 420

MADE IN ITALY

Cassettiera 3 cassette

L 420 mm x P 533 mm x H 555 mm

DESIGNER TAKIRO YUTA

DESCRIZIONE	Cassettiera a 3 cassette	COLORI	> Struttura disponibile in 4 colori standard: V1 bianco (RAL 9010) V6 alluminio (RAL 9006) V2 grigio tortora (RAL 7036) V22 nero (RAL 9005) > Colori standard semilucidi > Colori personalizzabili su richiesta previa disponibilità e con sovrapprezzo: www.dieffebi.com/docs/299/2832/DFB_Colour-Chart-2020.pdf
DIMENSIONI ESTERNE	L 420 mm x P 533 mm x H 555 mm	ACCESSORI	> Chiave master > Chiave per estrazione cilindro > Cilindro per serratura > Confezione 3 separatori obliqui per cassetto > Confezione 3 separatori verticali per cassetto > Confezione per sistema antiribaltamento > Chiusura ammortizzata > Vaschetta portamatite > Cuscino in tessuto con rinforzo > set 4 ruote senza freno > set 2 ruote con freno > set 4 ruote, 2 con freno, 2 senza freno > set 4 ruote gommate
DIMENSIONI INTERNE	Vano cassetto: L 330 x P 483 x H 75 mm > Altezza massima utile H 110 mm	PESO NETTO	17,92 Kg
PRODUZIONE	> Dieffebi S.p.a. > Inizio produzione: anno 1995 > Luogo di produzione: Italia	MANUTENZIONE	> Pulire con panno morbido > Non trattare le superfici con panni abrasivi
MATERIALI	> struttura in metallo riciclato e riciclabile	IMBALLO	> volume: 0,156 m ³ > In scatola di cartone riciclato e riciclabile con 8 angolari in polistirolo di protezione > Multiplo su pallet > Fornito montato (ad esclusione delle ruote) > N°colli: 1
FINITURA	> Verniciatura a polveri previo fosfosgrassaggio a caldo e fissaggio in forni a 180°; > vernici atossiche a zero emissioni; > spessore vernici: 80 micron	END OF USE	> Corredato di scheda di disassemblaggio per smaltimento.
COMPONENTI STANDARD	> Cassetti in metallo > Guida a rullo ad estrazione parziale > Ruote piroettanti diam. 50 mm > Chiusura centralizzata > Serratura con 2 chiavi (fissa+pieghevole) > Cilindro estraibile	GARANZIA	> Dieffebi garantisce che il prodotto è stato realizzato usando materiali di alta qualità - Vedi documento di garanzia.

Universal Mobile 420

MADE IN ITALY

Cassettiera a 3 cassetti

L 420 mm x P 533 mm x H 555 mm

DESIGNER TAKIRO YUTA

BENESSERE E AMBIENTE > Design "green" in accordo con gli standard LEED®, per progettare ed arredare ambienti ad alto contenuto di sostenibilità.



www.GreenTop.com



TEST STRUTTURA EN 14073-2/2004, par. 3.4
 EN 14073-3/2004, par. 5.4
 EN 14073-3/2004, par. 5.5
 EN 14074/2004, par. 6.2.1
 EN 14074/2004, par. 6.2.2
 EN 14074/2004, par. 6.2.3
 EN 14074/2004, par. 6.7
 EN 16122/2012 + AC:2015, par.7.5.5

TEST FINITURA UNI EN ISO 2409:2013 EN ISO 1520:2006
 NSS UNI EN ISO 9227:2017 UNI EN ISO 6272-1:2013
 UNI EN 15187:2007 UNI EN 15185:2011
 EN 12720:2013 UNI EN 15186:2012, met. B
 EN 12721:2013 UNI 9300:2015
 UNI 9429:2015

CERTIFICAZIONE NF Environnement
 Certifié par FCBA - Ameublement



CLASSE DI > Classe 0

REAZIONE AL FUOCO

POSIZIONAMENTO > Free Standing



dieffebi



MADE IN EUROPE

ASSUFFICIO
ASSOCIAZIONE FEDERLEGISNARREDO

ADIMEMBER

consip
acquistinretepa.it
Il Fornitore Aggiunto della Pubblica Amministrazione

Universal Mobile 420

Vernici
Varnish
Vernis
Lacke

Corpo
Cabinet Body
Caisson
Korpus

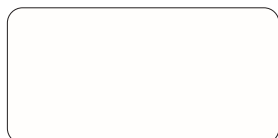

-V1
S711 (RAL 9010)
Pure white



-V6
S380 (RAL 9006)
White aluminium



-V2
7044 (RAL 7044)
Silk grey

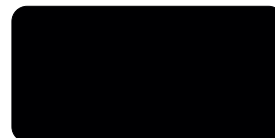

-V22
S811 (RAL 9005)
Jet black

Tessuti
Fabrics
Tissus
Textilien

Cuscino in tessuto con
rinforzo
Reinforced fabric seat
cushion
Coussin en tissu
renforcé
Verstärktes Stoffkissen



-T3
8009
Jet, Fidivi

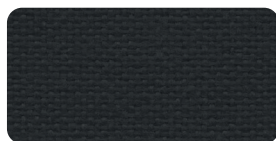

-T4
8033
Jet, Fidivi

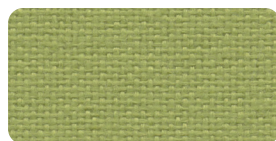

-T12
7041
Jet, Fidivi



-T7
213
Divina MD, Kvadrat

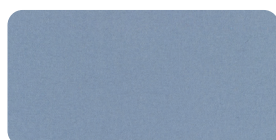

-T18
701
Hero, Kvadrat

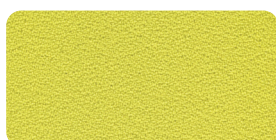

-T24
462
Mirage, Pugi - PG



-T31
133
Mirage, Pugi - PG

Universal Mobile 420

MADE IN ITALY

Cassettiera 1 cassetto + 1 cassetto classificatore

L 420 mm x P 533 mm x H 555 mm

DESIGNER TAKIRO YUTA

Struttura: metallo

V1 ○ bianco RAL 9010

V6 ● alluminio RAL 9006

V2 ● grigio tortora RAL 7004

V22 ● nero RAL 9005

art. 9N140612R S711

art. 9N140612R S380

art. 9N140612R 7044

art. 9N140612R S811

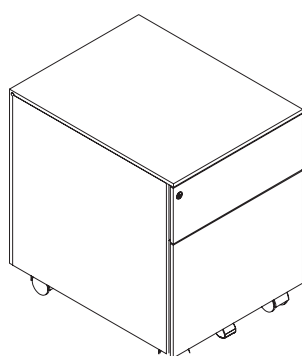

Fronte

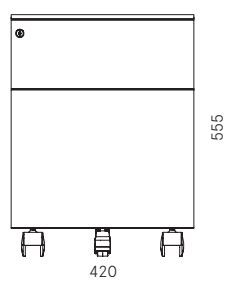

Fianco

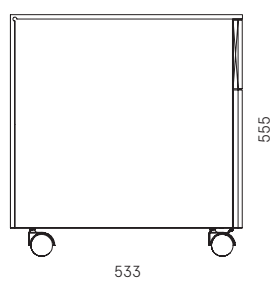

Retro

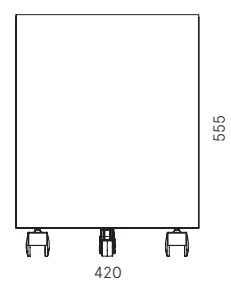

Universal Mobile 420

MADE IN ITALY

Cassettiera 1 cassetto + 1 cassetto classificatore

L 420 mm x P 533 mm x H 555 mm

DESIGNER TAKIRO YUTA

DESCRIZIONE	Cassettiera 1 cassetto + 1 cassetto classificatore	COLORI	<ul style="list-style-type: none"> > Struttura disponibile in 4 colori standard: V1 bianco (RAL 9010) V6 alluminio (RAL 9006) V2 grigio tortora (RAL 7036) V22 nero (RAL 9005) > Colori standard semilucidi > Colori personalizzabili su richiesta previa disponibilità e con sovrapprezzo: www.dieffebi.com/docs/299/2832/DFB_Colour-Chart-2020.pdf
DIMENSIONI ESTERNE	L 420 mm x P 533 mm x H 555 mm		
DIMENSIONI INTERNE	<ul style="list-style-type: none"> Vano cassetto: L 330 x P 483 x H 75 mm > Altezza massima utile H 110 mm Vano classificatore: L 325 x P 470 x H 238 mm > Altezza massima utile H 270 mm 		
CARTELLINE	Nr. 39 cartelline da 330 mm o 27 cartelline da 390 mm con l'utilizzo della barretta di divisione	ACCESSORI	<ul style="list-style-type: none"> > Chiave master > Chiave per estrazione cilindro > Cilindro per serratura > Barretta divisione per classificatore > Confezione 3 separatori obliqui per cassetto > Confezione 3 separatori verticali per cassetto > Confezione per sistema antiribaltamento > Chiusura ammortizzata (escluso il classificatore) > Vaschetta portamatite > Vaschetta portamatite per cassetto cancelleria > Cartellina sospesa da 330 o 390 mm > Cuscino in tessuto con rinforzo > 5° rotellina con staffa per ruote > set 4 ruote senza freno > set 2 ruote con freno > set 4 ruote, 2 con freno, 2 senza freno > set 4 ruote gommate
PRODUZIONE	<ul style="list-style-type: none"> > Dieffebi S.p.a. > Inizio produzione: anno 1995 > Luogo di produzione: Italia 		
MATERIALI	> struttura in metallo riciclato e riciclabile		
FINITURA	<ul style="list-style-type: none"> > Verniciatura a polveri previo fosfosgrassaggio a caldo e fissaggio in forni a 180°; > vernici atossiche a zero emissioni; > spessore vernici: 80 micron 		
MANUTENZIONE	<ul style="list-style-type: none"> > Pulire con panno morbido > Non trattare le superfici con panni abrasivi 		
COMPONENTI STANDARD	<ul style="list-style-type: none"> > Cassetti in metallo > Guida a rullo ad estrazione parziale > Guida a sfera ad estrazione totale sul classificatore > Ruote piroettanti diam. 50 mm > 5^ ruota antiribaltamento > Chiusura centralizzata > Serratura con 2 chiavi (fissa+pieghevole) > Cilindro estraibile 	PESO NETTO	18,06 Kg
		IMBALLO	<ul style="list-style-type: none"> > volume: 0,156 m³ > In scatola di cartone riciclato e riciclabile con 8 angolari in polistirolo di protezione > Multiplo su pallet > Fornito montato (ad esclusione delle ruote) > N°colli: 1
		END OF USE	> Corredato di scheda di disassemblaggio per smaltimento.
		GARANZIA	> Dieffebi garantisce che il prodotto è stato realizzato usando materiali di alta qualità - Vedi documento di garanzia.

Universal Mobile 420

MADE IN ITALY

Cassettiera 1 cassetto + 1 cassetto classificatore

L 420 mm x P 533 mm x H 555 mm

DESIGNER TAKIRO YUTA

BENESSERE E AMBIENTE > Design "green" in accordo con gli standard LEED®, per progettare ed arredare ambienti ad alto contenuto di sostenibilità.



TEST STRUTTURA EN 14073-2/2004, par. 3.4
 EN 14073-3/2004, par. 5.4
 EN 14073-3/2004, par. 5.5
 EN 14074/2004, par. 6.2.1
 EN 14074/2004, par. 6.2.2
 EN 14074/2004, par. 6.2.3
 EN 14074/2004, par. 6.7
 EN 16122/2012 + AC:2015, par.7.5.5

TEST FINITURA UNI EN ISO 2409:2013 EN ISO 1520:2006
 NSS UNI EN ISO 9227:2017 UNI EN ISO 6272-1:2013
 UNI EN 15187:2007 UNI EN 15185:2011
 EN 12720:2013 UNI EN 15186:2012, met. B
 EN 12721:2013 UNI 9300:2015
 UNI 9429:2015

CERTIFICAZIONE NF Environnement
 Certifié par FCBA - Ameublement



CLASSE DI > Classe 0

REAZIONE AL FUOCO

POSIZIONAMENTO > Free Standing



ADIMEMBER



Universal Mobile 420

Vernici
Varnish
Vernis
Lacke

Corpo
Cabinet Body
Caisson
Korpus



-V1
S711 (RAL 9010)
Pure white



-V6
S380 (RAL 9006)
White aluminium



-V2
7044 (RAL 7044)
Silk grey

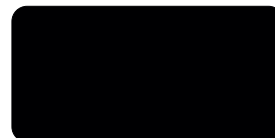

-V22
S811 (RAL 9005)
Jet black

Tessuti
Fabrics
Tissus
Textilien

Cuscino in tessuto con
rinforzo
Reinforced fabric seat
cushion
Cousin en tissu
renforcé
Verstärktes Stoffkissen



-T3
8009
Jet, Fidivi

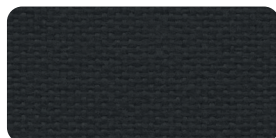

-T4
8033
Jet, Fidivi

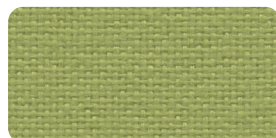

-T12
7041
Jet, Fidivi



-T7
213
Divina MD, Kvadrat

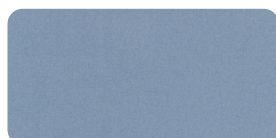

-T18
701
Hero, Kvadrat

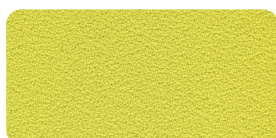

-T24
462
Mirage, Pugi - PG



-T31
133
Mirage, Pugi - PG

Universal Mobile 420

MADE IN ITALY

Cassettiera a 3 cassetti + 1 cassetto cancelleria

L 420 mm x P 533 mm x H 555 mm

DESIGNER TAKIRO YUTA

Struttura: metallo

V1 ○ bianco RAL 9010

V6 ● alluminio RAL 9006

V2 ● grigio tortora RAL 7004

V22 ● nero RAL 9005

art. 9N180612R S711

art. 9N180612R S380

art. 9N180612R 7044

art. 9N180612R S811

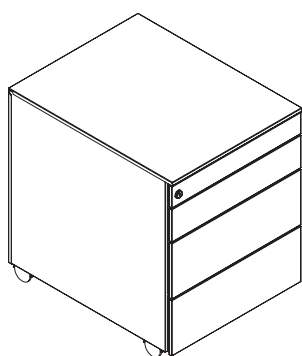

Fronte

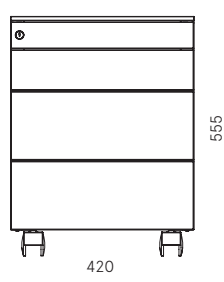

Fianco

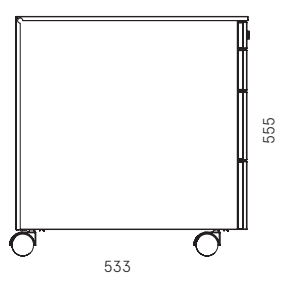

Retro

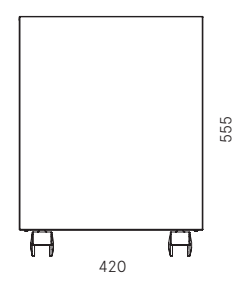

Universal Mobile 420

MADE IN ITALY

Cassettiera a 3 cassette + 1 cassetto cancelleria

L 420 mm x P 533 mm x H 555 mm

DESIGNER TAKIRO YUTA

DESCRIZIONE	Cassettiera a 3 cassette + 1 cassetto classificatore	COLORI	<ul style="list-style-type: none"> > Struttura disponibile in 4 colori standard: V1 bianco (RAL 9010) V6 alluminio (RAL 9006) V2 grigio tortora (RAL 7036) V22 nero (RAL 9005) > Colori standard semilucidi > Colori personalizzabili su richiesta previa disponibilità e con sovrapprezzo: www.dieffebi.com/docs/299/2832/DFB_Colour-Chart-2020.pdf
DIMENSIONI ESTERNE	L 420 mm x P 533 mm x H 555 mm		
DIMENSIONI INTERNE	<ul style="list-style-type: none"> Vano cassetto: L 330 x P 483 x H 75 mm > Cassetto intermedio: altezza massima utile H 86 mm > 2 cassette inferiori: altezza massima utile H 110 mm 		
PRODUZIONE	<ul style="list-style-type: none"> > Dieffebi S.p.a. > Inizio produzione: anno 1995 > Luogo di produzione: Italia 	ACCESSORI	<ul style="list-style-type: none"> > Chiave master > Chiave per estrazione cilindro > Cilindro per serratura > Confezione 3 separatori obliqui per cassetto > Confezione 3 separatori verticali per cassetto > Confezione per sistema antiribaltamento > Chiusura ammortizzata (escluso il cancelleria) > Vaschetta portamatite > Vaschetta portamatite per cassetto cancelleria > Cuscino in tessuto con rinforzo > set 4 ruote senza freno > set 2 ruote con freno > set 4 ruote, 2 con freno, 2 senza freno > set 4 ruote gommate
MATERIALI	> struttura in metallo riciclato e riciclabile		
FINITURA	<ul style="list-style-type: none"> > Verniciatura a polveri previo fosfosgrassaggio a caldo e fissaggio in forni a 180°; > vernici atossiche a zero emissioni; > spessore vernici: 80 micron 		
MANUTENZIONE	<ul style="list-style-type: none"> > Pulire con panno morbido > Non trattare le superfici con panni abrasivi 		
COMPONENTI STANDARD	<ul style="list-style-type: none"> > Cassetti in metallo > Guida a rullo ad estrazione parziale > Ruote piroettanti diam. 50 mm > Chiusura centralizzata > Serratura con 2 chiavi (fissa+pieghevole) > Cilindro estraibile 	PESO NETTO	20,09 Kg
		IMBALLO	<ul style="list-style-type: none"> > volume: 0,156 m³ > In scatola di cartone riciclato e riciclabile con 8 angolari in polistirolo di protezione > Multiplo su pallet > Fornito montato (ad esclusione delle ruote) > N°colli: 1
		END OF USE	> Corredato di scheda di disassemblaggio per smaltimento.
		GARANZIA	> Dieffebi garantisce che il prodotto è stato realizzato usando materiali di alta qualità - Vedi documento di garanzia.

Universal Mobile 420

MADE IN ITALY

Cassettiera a 3 cassette + 1 cassetto cancelleria

L 420 mm x P 533 mm x H 555 mm

DESIGNER TAKIRO YUTA

BENESSERE E AMBIENTE > Design "green" in accordo con gli standard LEED®, per progettare ed arredare ambienti ad alto contenuto di sostenibilità.



TEST STRUTTURA EN 14073-2/2004, par. 3.4
 EN 14073-3/2004, par. 5.4
 EN 14073-3/2004, par. 5.5
 EN 14074/2004, par. 6.2.1
 EN 14074/2004, par. 6.2.2
 EN 14074/2004, par. 6.2.3
 EN 14074/2004, par. 6.7
 EN 16122/2012 + AC:2015, par.7.5.5

TEST FINITURA	UNI EN ISO 2409:2013	EN ISO 1520:2006
	NSS UNI EN ISO 9227:2017	UNI EN ISO 6272-1:2013
	UNI EN 15187:2007	UNI EN 15185:2011
	EN 12720:2013	UNI EN 15186:2012, met. B
	EN 12721:2013	UNI 9300:2015
	UNI 9429:2015	

CERTIFICAZIONE NF Environnement
 Certifié par FCBA - Ameublement



CLASSE DI > Classe 0

REAZIONE AL FUOCO

POSIZIONAMENTO > Free Standing



dieffebi



MADE IN EUROPE

ASSUFFICIO
ASSOCIAZIONE FIDELIENEGARRECO

ADIMEMBER

consip
acquistinretepa.it
Il Fornitore degli Appalti della Pubblica Amministrazione

Dieffebi SpA

via Palù 36
San Vendemiano,
31020 Treviso - ItaliaT +39 0438 4715
F +39 0438 471600
exportsales@dieffebi.com
vendite@dieffebi.com
www.dieffebi.com

Universal Mobile 420

Vernici
Varnish
Vernis
Lacke

Corpo
Cabinet Body
Caisson
Korpus

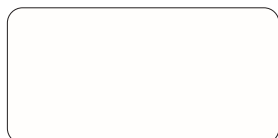

-V1
S711 (RAL 9010)
Pure white



-V6
S380 (RAL 9006)
White aluminium



-V2
7044 (RAL 7044)
Silk grey

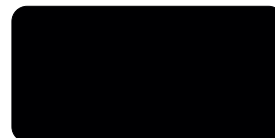

-V22
S811 (RAL 9005)
Jet black

Tessuti
Fabrics
Tissus
Textilien

Cuscino in tessuto con
rinforzo
Reinforced fabric seat
cushion
Coussin en tissu
renforcé
Verstärktes Stoffkissen



-T3
8009
Jet, Fidivi

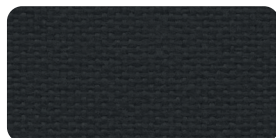

-T4
8033
Jet, Fidivi

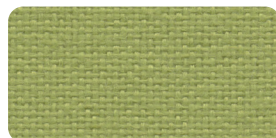

-T12
7041
Jet, Fidivi



-T7
213
Divina MD, Kvadrat

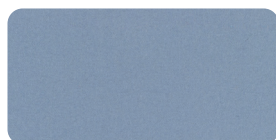

-T18
701
Hero, Kvadrat



-T24
462
Mirage, Pugi - PG



-T31
133
Mirage, Pugi - PG

Universal Mobile 420

MADE IN ITALY

Cassettiera 1 cassetto, 1 classificatore
e cassetto cancelleria

L 420 mm x P 533 mm x H 555 mm

Struttura: metallo

V1 ○ bianco RAL 9010

art. 9N170612R S711

V6 ● alluminio RAL 9006

art. 9N170612R S380

V2 ● grigio tortora RAL 7004

art. 9N170612R 7044

V22 ● nero RAL 9005

art. 9N170612R S811

DESIGNER TAKIRO YUTA

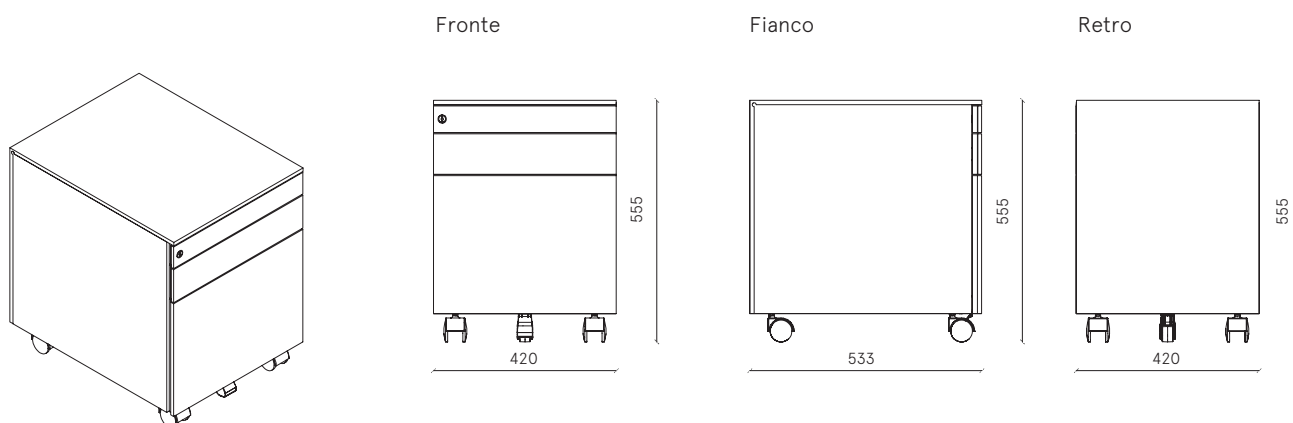

Universal Mobile 420

MADE IN ITALY

Cassettiera 1 cassetto, 1 classificatore
e cassetto cancelleria
L 420 mm x P 533 mm x H 555 mm

DESIGNER TAKIRO YUTA

DESCRIZIONE	Cassettiera 1 cassetto, 1 classificatore e cassetto cancelleria	COLORI	<ul style="list-style-type: none"> > Struttura disponibile in 4 colori standard: V1 bianco (RAL 9010) V6 alluminio (RAL 9006) V2 grigio tortora (RAL 7036) V22 nero (RAL 9005) > Colori standard semilucidi > Colori personalizzabili su richiesta previa disponibilità e con sovrapprezzo: www.dieffebi.com/docs/299/2832/DFB_Colour-Chart-2020.pdf
DIMENSIONI ESTERNE	L 420 mm x P 533 mm x H 555 mm		
DIMENSIONI INTERNE	<ul style="list-style-type: none"> Vano cassetto: L 330 x P 483 x H 75 mm > Altezza massima utile H 86 mm Vano classificatore: L 325 x P 470 x H 238 mm > Altezza massima utile H 270 mm Vano cancelleria: L 332 x P 486 x H 39 mm 		
CARTELLINE	Nr. 39 cartelline da 330 mm o 27 cartelline da 390 mm con l'utilizzo della barretta di divisione	ACCESSORI	<ul style="list-style-type: none"> > Chiave master > Chiave per estrazione cilindro > Cilindro per serratura > Barretta divisione per classificatore > Confezione 3 separatori obliqui per cassetto > Confezione 3 separatori verticali per cassetto > Confezione per sistema antiribaltamento > Chiusura ammortizzata (escluso il classificatore) > Vaschetta portamatite > Vaschetta portamatite per cassetto cancelleria > Cartellina sospesa da 330 o 390 mm > Cuscino in tessuto con rinforzo > 5° rotellina con staffa per ruote > set 4 ruote senza freno > set 2 ruote con freno > set 4 ruote, 2 con freno, 2 senza freno > set 4 ruote gommate
PRODUZIONE	<ul style="list-style-type: none"> > Dieffebi S.p.a. > Inizio produzione: anno 1995 > Luogo di produzione: Italia 		
MATERIALI	> struttura in metallo riciclato e riciclabile		
FINITURA	<ul style="list-style-type: none"> > Verniciatura a polveri previo fosfosgrassaggio a caldo e fissaggio in forni a 180°; > vernici atossiche a zero emissioni; > spessore vernici: 80 micron 		
MANUTENZIONE	<ul style="list-style-type: none"> > Pulire con panno morbido > Non trattare le superfici con panni abrasivi 		
COMPONENTI STANDARD	<ul style="list-style-type: none"> > Cassetti in metallo > Guida a rullo ad estrazione parziale > Guida a sfera ad estrazione totale sul classificatore > Ruote piroettanti diam. 50 mm > 5^ ruota antiribaltamento > Chiusura centralizzata > Serratura con 2 chiavi (fissa+pieghevole) > Cilindro estraibile 	PESO NETTO	20,23 Kg
		IMBALLO	<ul style="list-style-type: none"> > volume: 0,156 m³ > In scatola di cartone riciclato e riciclabile con 8 angolari in polistirolo di protezione > Multiplo su pallet > Fornito montato (ad esclusione delle ruote) > N°colli: 1
		END OF USE	> Corredato di scheda di disassemblaggio per smaltimento.
		GARANZIA	> Dieffebi garantisce che il prodotto è stato realizzato usando materiali di alta qualità - Vedi documento di garanzia.

Universal Mobile 420

MADE IN ITALY

Cassettiera 1 cassetto, 1 classificatore
e cassetto cancelleria

L 420 mm x P 533 mm x H 555 mm

DESIGNER TAKIRO YUTA

BENESSERE E AMBIENTE > Design "green" in accordo con gli standard LEED®, per progettare ed arredare ambienti ad alto contenuto di sostenibilità.



www.GreenTop.com



TEST STRUTTURA EN 14073-2/2004, par. 3.4
EN 14073-3/2004, par. 5.4
EN 14073-3/2004, par. 5.5
EN 14074/2004, par. 6.2.1
EN 14074/2004, par. 6.2.2
EN 14074/2004, par. 6.2.3
EN 14074/2004, par. 6.7
EN 16122/2012 + AC:2015, par.7.5.5

TEST FINITURA UNI EN ISO 2409:2013 EN ISO 1520:2006
NSS UNI EN ISO 9227:2017 UNI EN ISO 6272-1:2013
UNI EN 15187:2007 UNI EN 15185:2011
EN 12720:2013 UNI EN 15186:2012, met. B
EN 12721:2013 UNI 9300:2015
UNI 9429:2015

CERTIFICAZIONE NF Environnement
Certifié par FCBA - Ameublement



CLASSE DI > Classe 0

REAZIONE AL FUOCO

POSIZIONAMENTO > Free Standing



dieffebi



MADE IN EUROPE



ASSUFFICIO
ASSOCIAZIONE FIDELI/LEGISLATORE

ADIMEMBER



consip
acquistinretepa.it

Dieffebi SpA

via Palù 36
San Vendemiano,
31020 Treviso - Italia

T +39 0438 4715
F +39 0438 471600
exportsales@dieffebi.com
vendite@dieffebi.com
www.dieffebi.com

Universal Mobile 420

Vernici
Varnish
Vernis
Lacke

Corpo
Cabinet Body
Caisson
Korpus



-V1
S711 (RAL 9010)
Pure white



-V6
S380 (RAL 9006)
White aluminium



-V2
7044 (RAL 7044)
Silk grey

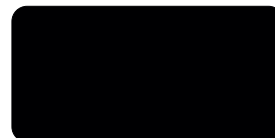

-V22
S811 (RAL 9005)
Jet black

Tessuti
Fabrics
Tissus
Textilien

Cuscino in tessuto con
rinforzo
Reinforced fabric seat
cushion
Coussin en tissu
renforcé
Verstärktes Stoffkissen



-T3
8009
Jet, Fidivi

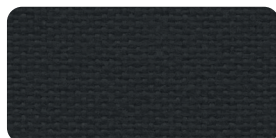

-T4
8033
Jet, Fidivi

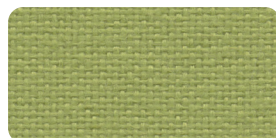

-T12
7041
Jet, Fidivi



-T7
213
Divina MD, Kvadrat

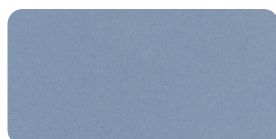

-T18
701
Hero, Kvadrat



-T24
462
Mirage, Pugi - PG



-T31
133
Mirage, Pugi - PG