

DotBox

MADE IN ITALY

Unità anta a ribalta verso il basso V1  bianco RAL 9010 art.6D0100030 S711
 L 800 x P 410 x H 400/413 mm V2  tortora RAL 7044 art.6D0100030 7044

DESIGNER Hangar Design Group

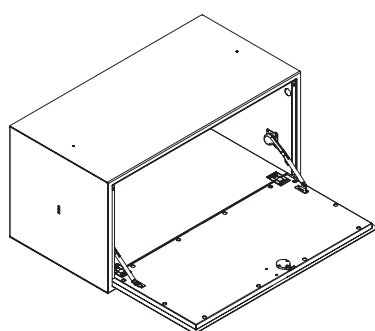

Fronte

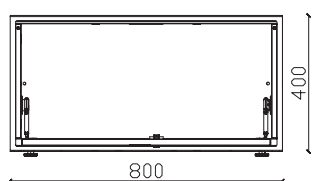

Fianco

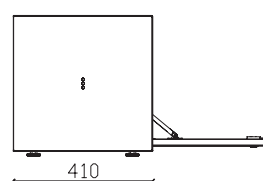

Retro

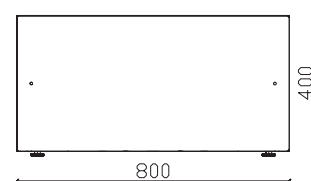

Dettaglio Piede

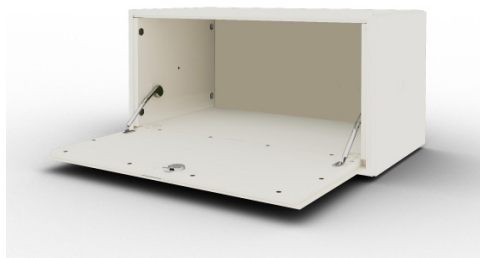
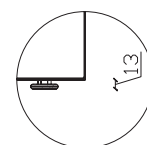

DotBox

MADE IN ITALY

Unità anta a ribalta verso il basso
L 800 x P 410 x H 400/413 mm

DESIGNER Hangar Design Group

DESCRIZIONE Sistema modulare

DIMENSIONI ESTERNE L 800 mm x P 410 mm x H 400/413 mm

DIMENSIONI INTERNE VANO L 765 mm x P 405 mm x H 336 mm

DOX Capienza Dox N°8 h 320 mm

PRODUZIONE

- > Dieffebi S.p.a.
- > Inizio produzione: anno 2013
- > Luogo di produzione: Italia

MANUTENZIONE

- > Pulire con panno morbido.
- > Non trattare le superfici con panni abrasivi.

MATERIALI > struttura: in metallo riciclato e riciclabile

FINITURA

- > Verniciatura a polveri basso emissive (materiale inerte)
- > Esenti da metalli pesanti
- > Assenza di spigoli vivi e bordi taglienti
- > Finitura anti riflesso
- > Non contiene VOC

COMPONENTI STANDARD

- > Maniglia in materiale plastico verniciato con colore di serie grigio antracite RAL 7021
- > Serratura a cilindro con due chiavi (fissa + pieghevole), chiusura centralizzata e cilindro estraibile
- > Disponibile chiave master su richiesta
- > Piedini in Nylon 13mmH
- > Viti per fissaggio tra moduli

COLORI

- > Disponibile in 2 colori standard
- > Colori standard semilucidi
- > Colori personalizzabili su richiesta previa disponibilità e con sovrapprezzo: www.dieffebi.com/docs/299/2832/DFB_Colour-Chart-2020.pdf.
- > www.dieffebi.com/it/news

ACCESSORI

- > Top in vetro laccato bianco RAL 9010
- > Pannelli interni in metallo disponibile in 4 colori di serie: verde, azzurro, rosso, giallo
- > Pannelli esterni in tessuto disponibile in 7 colori standard: verde, grigio, nero, azzurro, beige chiaro, arancio, giallo
- > Pannello esterno in legno
- > Fissaggio pannelli: con adesivo
- > Maniglia in materiale plastico verniciato disponibile in 5 colori
- > Cuscini in tessuto ignifugo classe M1 disponibili in 7 colori standard: verde, grigio, nero, azzurro, beige chiaro, arancio, giallo
- > Piedini cromati livellatori h 110 mm
- > 4 Ruote piroettanti da ø 65 mm - con freno
- > 4 Ruote piroettanti da ø 65 mm - senza freno

PESO NETTO 26,00 Kg

IMBALLO

- > volume: 0,19 m³
- > In cartone riciclato e riciclabile
- > Multiplo su pallet
- > Ottimizzato per il trasporto con riduzione di CO₂
- > Fornito: Montato
- > N°colli: 1

END OF USE > Corredato di scheda di disassemblaggio per smaltimento.

GARANZIA > Dieffebi garantisce che il prodotto è stato realizzato usando materiali di alta qualità - Vedi documento di garanzia.

MADE IN ITALY

Unità anta a ribalta verso il basso
L 800 x P 410 x H 400/413 mm

DESIGNER Hangar Design Group

BENESSERE E AMBIENTE > Design "green" in accordo con gli standard LEED®, per progettare ed arredare ambienti ad alto contenuto di sostenibilità.



www.GreenTop.com



VINCOLI ASSEMBLAGGIO > Composizioni:

a muro centro stanza su ruote

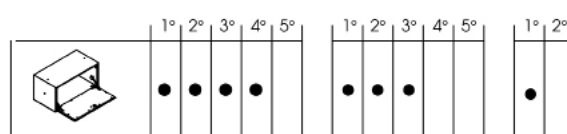

> Composizione: esempio

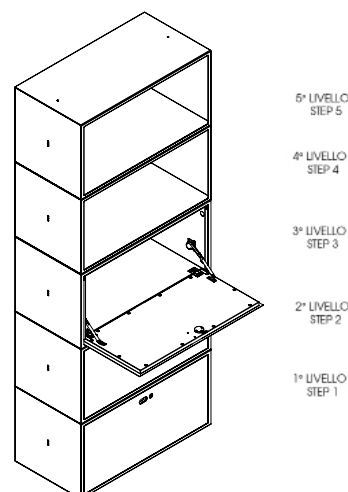

5° LIVELLO
STEP 5

4° LIVELLO
STEP 4

3° LIVELLO
STEP 3

2° LIVELLO
STEP 2

1° LIVELLO
STEP 1

TEST STRUTTURA > Laboratorio CATAS
ANSI/BIFMA X5.9-2012, CLAUSE 20

TEST FINITURA > UNI EN ISO 2409:2013 > EN ISO 1520:2006
> NSS UNI EN ISO 9227:2017 > UNI 9300:2015
> UNI EN 15187:2007 > UNI EN ISO 6272-1:2013
> EN 12720:2013 > UNI EN 15185:2011
> EN 12721:2013 > UNI EN 15186:2012, met.B
> UNI 9429:2015

CLASSE DI > Classe 0

REAZIONE AL FUOCO

POSIZIONAMENTO > Sia a muro che in centro stanza

MODULARITÀ > Verticale e orizzontale



dieffebi



MADE IN EUROPE



ASSUFFICIO
ASSOCIAZIONE FIDELIENSDARRECO

ADIMEMBER



consip
acquistinretepa.it

Dieffebi SpA

via Palù 36
San Vendemiano,
31020 Treviso - Italia

T +39 0438 4715
F +39 0438 471600
exportsales@dieffebi.com
vendite@dieffebi.com
www.dieffebi.com

DotBox

MADE IN ITALY

Vernici
Varnish
Vernis
Lacke

Corpo
Cabinet Body
Caisson
Korpus

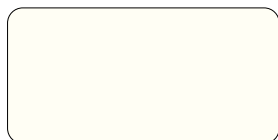

-V1
S711 (RAL 9010)
Pure white



-V2
7044 (RAL 7044)
Silk grey

Pannello interno
in metallo colorato
Metal coloured panel
Panneau Interne
en métal coloré
arbigees Metallpaneel



- V8
6013 (RAL 6013)
Reed green



- V15
1021 (RAL 1021)
Rape yellow



-V17
5024 (RAL 5024)
Pastel blue



-V24
3005 (RAL 3005)
Wine red

Maniglie
Handles
Poignées
Griffe



-V8
6013 (RAL 6013)
Reed green



- V15
1021 (RAL 1021)
Rape yellow



-V17
5024 (RAL 5024)
Pastel blue



-V24
3005 (RAL 3005)
Wine red

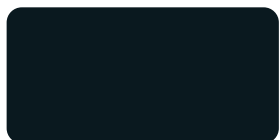

-V19
S210 (RAL 7021)
Black grey

Legno
Wood
Bois
Holz

Pannello esterno in legno
External wooden panel
Panneau extérieur en bois
Außenpaneel aus Holz



- W2
Castagno chiaro
/Light chestnut
/Châtaignier clair
/Kastanienholz hell

DotBox

MADE IN ITALY

Vetro
Glass
Verre
Glas

Laccato
Lacquer
Laqué
Lackiert

Piano
Top
Plateau
Tischplatte



-G1
Bianco/White/Blanc/Weiß

Tessuti
Fabrics
Tissus
Textilien

Cuscino
Cushion
Coussin
Sitzkissen



- T3
8009
Jet, Fidivi

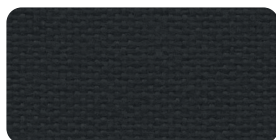

- T4
8033
Jet, Fidivi



-T7
213
Divina MD, Kvadrat



-T12
7041
Jet, Fidivi

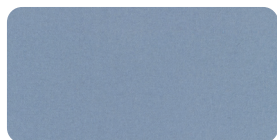

- T18
701
Hero, Kvadrat



- T24
462
Mirage, Pugi · PG



-T31
133
Mirage, Pugi · PG

Pannello esterno
External panel
Panneau extérieur
Außenpaneel



- T3
8009
Jet, Fidivi

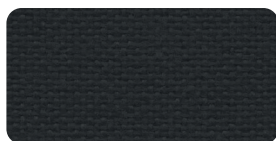

- T4
8033
Jet, Fidivi



-T7
213
Divina MD, Kvadrat

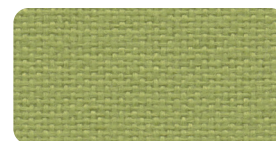

-T12
7041
Jet, Fidivi

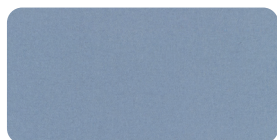

- T18
701
Hero, Kvadrat



- T24
462
Mirage, Pugi · PG



-T31
133
Mirage, Pugi · PG