

DotBox

MADE IN ITALY

Cassettiera V1  bianco RAL 9010 art.6DB00010P S711
L 400 x P 410 x H 400/413 mm V2  tortora RAL 7044 art.6DB00010P 7044

DESIGNER Hangar Design Group

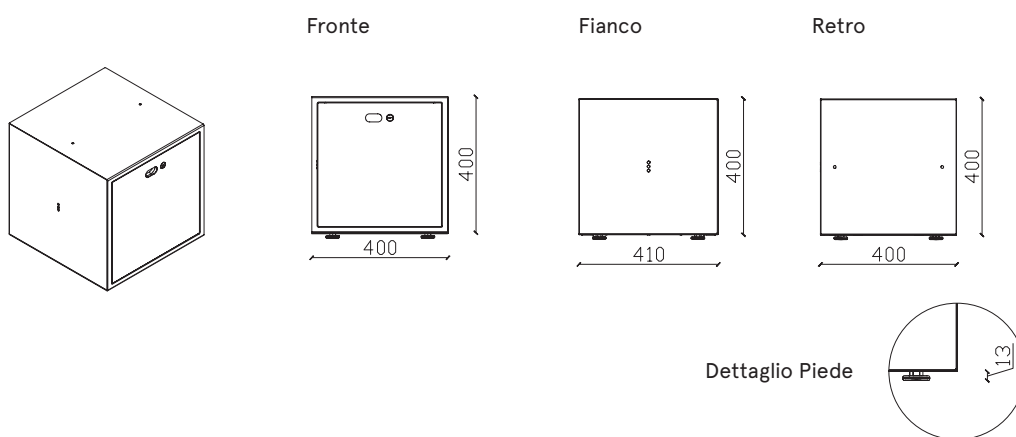

DotBox

MADE IN ITALY

Cassettiera

L 400 x P 410 x H 400/413 mm

DESIGNER Hangar Design Group

DESCRIZIONE Sistema modulare

DIMENSIONI L 400 mm x P 410 mm x H 400/413 mm

ESTERNE

DIMENSIONI Cassetto class. L 285 mm x P 325 mm x H 255 mm

INTERNE VANO

DOX Capienza Dox N°8 h 320 mm

CARTELLINE Capienza N° 22 cartelline da 330 mm in verticale

PRODUZIONE > Dieffebi S.p.a.
> Inizio produzione: anno 2013
> Luogo di produzione: Italia

MANUTENZIONE > Pulire con panno morbido.
> Non trattare le superfici con panni abrasivi.

MATERIALI > struttura: in metallo riciclato e riciclabile

FINITURA > Verniciatura a polveri basso emissive (materiale inerte)
> Esenti da metalli pesanti
> Assenza di spigoli vivi e bordi taglienti
> Finitura anti riflesso
> Non contiene VOC

COMPONENTI STANDARD > Maniglia in materiale plastico verniciato con colore di serie grigio antracite RAL 7021
> Serratura a cilindro con due chiavi (fissa + pieghevole), chiusura centralizzata e cilindro estraibile
> Disponibile chiave master su richiesta
> Guide: nascoste a scorrimento ammortizzato ad estrazione totale
> Cassetto classificatore: dotato di cavalieri porta cartelle predisposto per cartelle sospese.
> Contrappeso incluso
> Piedini in Nylon 13mmH
> Viti per fissaggio tra moduli

COLORI > Disponibile in 2 colori standard
> Colori standard semilucidi
> Colori personalizzabili su richiesta previa disponibilità e con sovrapprezzo:
www.dieffebi.com/docs/299/2832/DFB_Colour-Chart-2020.pdf
www.dieffebi.com/it/news

ACCESSORI > Top in vetro laccato bianco RAL 9010
> Maniglia in materiale plastico verniciato disponibile in 5 colori
> Cuscini in tessuto ignifugo classe M1 disponibili in 7 colori standard: verde, grigio, nero, azzurro, beige chiaro, arancio, giallo
> Piedini cromati livellatori h 110 mm
> 4 Ruote piroettanti da ø 65 mm - con freno
> 4 Ruote piroettanti da ø 65 mm - senza freno

PESO NETTO 27,10 Kg

IMBALLO > volume: 0,10 m³
> In cartone riciclato e riciclabile
> Multiplo su pallet
> Ottimizzato per il trasporto con riduzione di CO2
> Fornito: Montato
> N°colli: 1

END OF USE > Corredato di scheda di disassemblaggio per smaltimento.

GARANZIA > Dieffebi garantisce che il prodotto è stato realizzato usando materiali di alta qualità - Vedi documento di garanzia.

DotBox

MADE IN ITALY

Cassettiera

L 400 x P 410 x H 400/413 mm

DESIGNER Hangar Design Group

BENESSERE E
AMBIENTE

> Design "green" in accordo con gli standard LEED®, per progettare ed arredare ambienti ad alto contenuto di sostenibilità.

VINCOLI
ASSEMBLAGGIO

> Composizioni:

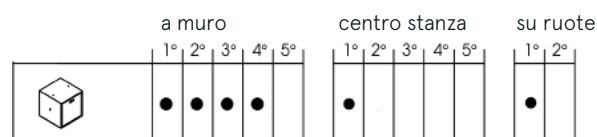

TEST FINITURA

- > UNI EN ISO 2409:2013
- > EN ISO 1520:2006
- > NSS UNI EN ISO 9227:2017
- > UNI 9300:2015
- > UNI EN 15187:2007
- > UNI EN ISO 6272-1:2013
- > EN 12720:2013
- > UNI EN 15185:2011
- > EN 12721:2013
- > UNI EN 15186:2012, met.B
- > UNI 9429:2015

> Composizione: esempio

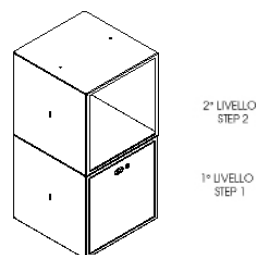

CLASSE DI

> Classe 0

REAZIONE AL
FUOCO

POSIZIONAMENTO > Sia a muro che in centro stanza

MODULARITÀ

> Verticale e orizzontale



ADIMEMBER



DotBox

MADE IN ITALY

Vernici
Varnish
Vernis
Lacke

Corpo
Cabinet Body
Caisson
Korpus

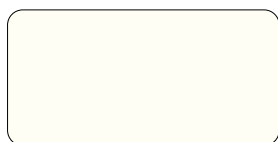

-V1
S711 (RAL 9010)
Pure white



-V2
7044 (RAL 7044)
Silk grey

Maniglie
Handles
Poignées
Griffe



-V8
6013 (RAL 6013)
Reed green



-V15
1021 (RAL 1021)
Rape yellow



-V17
5024 (RAL 5024)
Pastel blue



-V24
3005 (RAL 3005)
Wine red



-V19
S210 (RAL 7021)
Black grey

Vetro
Glass
Verre
Glas

Laccato
Lacquer
Laqué
Lackiert

Piano
Top
Plateau
Tischplatte



-G1
Bianco/White/Blanc/Weiß

DotBox

MADE IN ITALY

Tessuti
Fabrics
Tissus
Textilien

Cuscino
Cushion
Cousin
Sitzkissen



- T3
8009
Jet, Fidivi

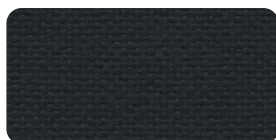

- T4
8033
Jet, Fidivi



-T7
213
Divina MD, Kvadrat

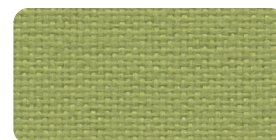

-T12
7041
Jet, Fidivi

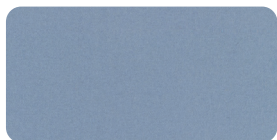

- T18
701
Hero, Kvadrat



- T24
462
Mirage, Pugi · PG



-T31
133
Mirage, Pugi · PG

DotBox

MADE IN ITALY

Cassettiera su ruote
L 400 x P 410 x H 470 mm

V1 ○ bianco RAL 9010 art.6D0400010 S711
V2 ● tortora RAL 7044 art.6D0400010 7044

DESIGNER Hangar Design Group

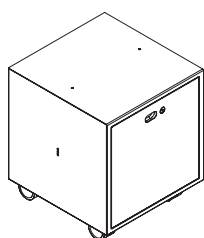

Fronte

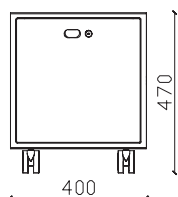

Fianco

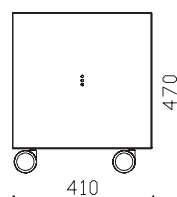

Retro

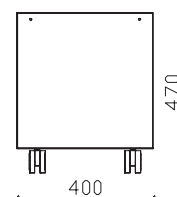

DotBox

MADE IN ITALY

Cassettiera su ruote

L 400 x P 410 x H 470 mm

DESIGNER Hangar Design Group

DESCRIZIONE Sistema modulare

DIMENSIONI L 400 mm x P 410 mm x H 470 mm

ESTERNE

DIMENSIONI Cassetto class. L 285 mm x P 325 mm x H 255 mm

INTERNE VANO

CARTELLINE Capienza N°22 cartelline da 330 mm in verticale

PRODUZIONE > Dieffebi S.p.a.
> Inizio produzione: anno 2013
> Luogo di produzione: Italia

MANUTENZIONE > Pulire con panno morbido.
> Non trattare le superfici con panni abrasivi.

MATERIALI > struttura: in metallo riciclato e riciclabile

FINITURA > Verniciatura a polveri basso emissive (materiale inerte)
> Esenti da metalli pesanti
> Assenza di spigoli vivi e bordi taglienti
> Finitura anti riflesso
> Non contiene VOC

COMPONENTI STANDARD > Maniglia in materiale plastico verniciato con colore di serie grigio antracite RAL 7021
> Serratura a cilindro con due chiavi (fissa + pieghevole), chiusura centralizzata e cilindro estraibile
> Disponibile chiave master su richiesta
> Guide: nascoste a scorrimento ammortizzato ad estrazione totale
> Cassetto classificatore: completamente chiuso dotato di cavalieri porta cartelle predisposto per cartelle sospese da 330 mm.
> Contrappeso incluso
> Viti per fissaggio tra moduli

COLORI > Disponibile in 2 colori standard
> Colori standard semilucidi
> Colori personalizzabili su richiesta previa disponibilità e con sovrapprezzo:
www.dieffebi.com/docs/299/2832/DFB_Colour-Chart-2020.pdf.
www.dieffebi.com/it/news

ACCESSORI > Top in vetro laccato bianco RAL 9010
> Maniglia in materiale plastico verniciato disponibile in 5 colori
> Cuscini in tessuto ignifugo classe M1 disponibili in 7 colori standard: verde, grigio, nero, azzurro, beige chiaro, arancio, giallo
> 4 Ruote piroettanti da \varnothing 65 mm - con freno

PESO NETTO 27,50 Kg

IMBALLO > volume: 0,10 m³
> In cartone riciclato e riciclabile
> Multiplo su pallet
> Ottimizzato per il trasporto con riduzione di CO2
> Fornito: Montato
> N°colli: 1

END OF USE > Corredato di scheda di disassemblaggio per smaltimento.

GARANZIA > Dieffebi garantisce che il prodotto è stato realizzato usando materiali di alta qualità - Vedi documento di garanzia.

DotBox

MADE IN ITALY

Cassettiera su ruote

L 400 x P 410 x H 470 mm

DESIGNER Hangar Design Group

BENESSERE E
AMBIENTE

> Design "green" in accordo con gli standard LEED®, per progettare ed arredare ambienti ad alto contenuto di sostenibilità.



TEST FINITURA

- > UNI EN ISO 2409:2013
- > EN ISO 1520:2006
- > NSS UNI EN ISO 9227:2017
- > UNI 9300:2015
- > UNI EN 15187:2007
- > UNI EN ISO 6272-1:2013
- > EN 12720:2013
- > UNI EN 15185:2011
- > EN 12721:2013
- > UNI EN 15186:2012, met.B
- > UNI 9429:2015

CLASSE DI

> Classe 0

REAZIONE AL
FUOCO

POSIZIONAMENTO > Libera su ruote

VINCOLI
ASSEMBLAGGIO

> Composizioni:

a muro

centro stanza

su ruote

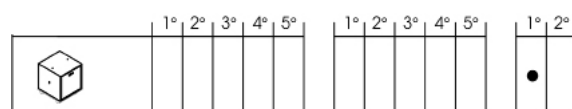

> Composizione: esempio composizione

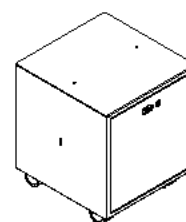
1° LIVELLO
STEP 1

ADIMEMBER



acquistinretepa.it
Il Fornitore Aggiuntivo della Pubblica Amministrazione

DotBox

MADE IN ITALY

Vernici
Varnish
Vernis
Lacke

Corpo
Cabinet Body
Caisson
Korpus

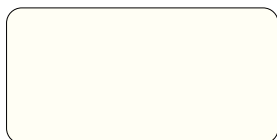

-V1
S711 (RAL 9010)
Pure white



-V2
7044 (RAL 7044)
Silk grey

Maniglie
Handles
Poignées
Griffe



-V8
6013 (RAL 6013)
Reed green



-V15
1021 (RAL 1021)
Rape yellow



-V17
5024 (RAL 5024)
Pastel blue



-V24
3005 (RAL 3005)
Wine red



-V19
S210 (RAL 7021)
Black grey

Vetro
Glass
Verre
Glas

Piano
Top
Plateau
Tischplatte



-G1
Bianco/White/Blanc/Weiß

DotBox

MADE IN ITALY

Tessuti
Fabrics
Tissus
Textilien

Cuscino
Cushion
Cousin
Sitzkissen



— T3
8009
Jet, Fidivi

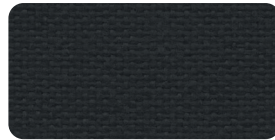

— T4
8033
Jet, Fidivi



— T7
213
Divina MD, Kvadrat



— T12
7041
Jet, Fidivi

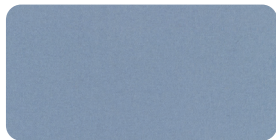

— T18
701
Hero, Kvadrat



— T24
462
Mirage, Pugi · PG



— T31
133
Mirage, Pugi · PG

DotBox

MADE IN ITALY

Unità un Cassetto Classificatore V1  bianco RAL 9010 art.6D0100010 S711
 L 800 x P 410 x H 400/413 mm V2  tortora RAL 7044 art.6D0100010 7044

DESIGNER Hangar Design Group

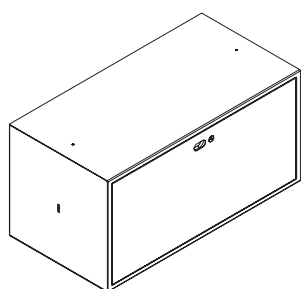

Fronte

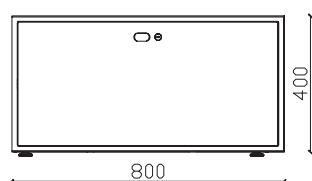

Fianco

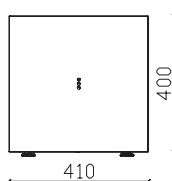

Retro

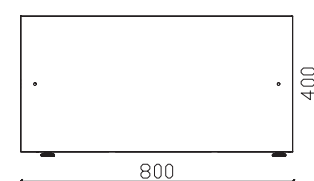

Dettaglio Piede

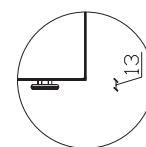

DotBox

MADE IN ITALY

Unità un Cassetto Classificatore
L 800 x P 410 x H 400/413 mm

DESIGNER Hangar Design Group

DESCRIZIONE	Sistema modulare
DIMENSIONI ESTERNE	L 800 mm x P 410 mm x H 400/413 mm
DIMENSIONI INTERNE VANO	Cassetto classificatore L 685 mm x P 325 mm x H 283 mm
CARTELLINE	Capienza N° 45 cartelline da 330 mm in verticale Capienza N° 40 cartelline da 330 mm in orizzontale
PRODUZIONE	> Dieffebi S.p.a. > Inizio produzione: anno 2013 > Luogo di produzione: Italia
MANUTENZIONE	> Pulire con panno morbido. > Non trattare le superfici con panni abrasivi.
MATERIALI	> struttura: in metallo riciclato e riciclabile
FINITURA	> Verniciatura a polveri basso emissive (materiale inerte) > Esenti da metalli pesanti > Assenza di spigoli vivi e bordi taglienti > Finitura anti riflesso > Non contiene VOC
COMPONENTI STANDARD	> Cassetto classificatore: dotato di cavalieri porta cartelle predisposto per cartelle sospese. > Maniglia in materiale plastico verniciato con colore di serie grigio antracite RAL 7021 > Serratura a cilindro con due chiavi (fissa + pieghevole), chiusura centralizzata e cilindro estraibile > Disponibile chiave master su richiesta > Guide: nascoste a scorrimento ammortizzato ad estrazione totale > Contrappeso non incluso > Piedini in Nylon 13mmH > Viti per fissaggio tra moduli

COLORI	> Disponibile in 2 colori standard > Colori standard semilucidi > Colori personalizzabili su richiesta previa disponibilità e con sovrapprezzo: www.dieffebi.com/docs/299/2832/DFB_Colour-Chart-2020.pdf www.dieffebi.com/it/news
ACCESSORI	> Top in vetro laccato bianco RAL 9010 > Maniglia in materiale plastico verniciato disponibile in 5 colori > Pannello esterno in tessuto disponibile in 7 colori standard: verde, grigio, nero, azzurro, beige chiaro, arancio, giallo. > Pannello esterno in legno > Fissaggio pannelli: con adesivo > Cuscini in tessuto ignifugo classe M1 disponibili in 7 colori standard: verde, grigio, nero, azzurro, beige chiaro, arancio, giallo > Piedini cromati livellatori h 110 mm > 4 Ruote piroettanti da ø 65 mm - con freno > 4 Ruote piroettanti da ø 65 mm - senza freno > Contrappeso
PESO NETTO	30,50 Kg
IMBALLO	> volume: 0,19 m ³ > In cartone riciclato e riciclabile > Multiplo su pallet > Ottimizzato per il trasporto con riduzione di CO2 > Fornito: Montato > N°colli: 1
END OF USE	> Corredato di scheda di disassemblaggio per smaltimento.
GARANZIA	> Dieffebi garantisce che il prodotto è stato realizzato usando materiali di alta qualità - Vedi documento di garanzia.

DotBox

MADE IN ITALY

Unità un Cassetto Classificatore
L 800 x P 410 x H 400/413 mm

DESIGNER Hangar Design Group

BENESSERE E AMBIENTE > Design "green" in accordo con gli standard LEED®, per progettare ed arredare ambienti ad alto contenuto di sostenibilità.



TEST STRUTTURA > Laboratorio CATAS
ANSI/BIFMA X5.9-2012, CLAUSE 20

TEST FINITURA > UNI EN ISO 2409:2013 > EN ISO 1520:2006
> NSS UNI EN ISO 9227:2017 > UNI 9300:2015
> UNI EN 15187:2007 > UNI EN ISO 6272-1:2013
> EN 12720:2013 > UNI EN 15185:2011
> EN 12721:2013 > UNI EN 15186:2012, met.B
> UNI 9429:2015

CLASSE DI > Classe 0

REAZIONE AL FUOCO

POSIZIONAMENTO > Sia a muro che in centro stanza

MODULARITÀ > Verticale e orizzontale

VINCOLI ASSEMBLAGGIO > Composizioni:

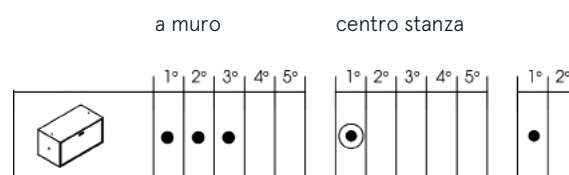

● OBBLIGATORIO CONTRAPPESO INTERNO AGGIUNTO
ADDITIONAL INTERNAL COUNTER WEIGHT REQUIRED

> Composizione: esempio composizione a muro

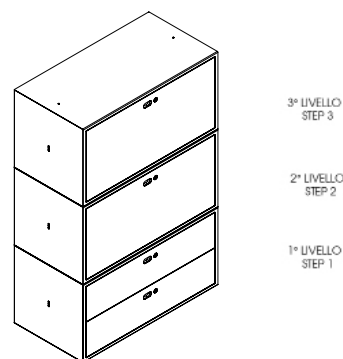

ADIMEMBER



DotBox

MADE IN ITALY

Vernici
Varnish
Vernis
Lacke

Corpo
Cabinet Body
Caisson
Korpus

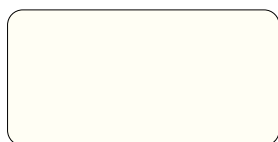

-V1
S711 (RAL 9010)
Pure white



-V2
7044 (RAL 7044)
Silk grey

Maniglie
Handles
Poignées
Griffe



-V8
6013 (RAL 6013)
Reed green



-V15
1021 (RAL 1021)
Rape yellow



-V17
5024 (RAL 5024)
Pastel blue



-V24
3005 (RAL 3005)
Wine red

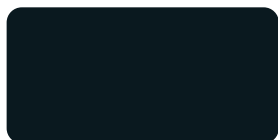

-V19
S210 (RAL 7021)
Black grey

Legno
Wood
Bois
Holz

Pannello esterno in legno
External wooden panel
Panneau extérieur en bois
Außenpaneel aus Holz



- W2
Castagno chiaro
/Light chestnut
/Châtaignier clair
/Kastanienholz hell

DotBox

MADE IN ITALY

Vetro
Glass
Verre
Glas

Laccato
Lacquer
Laqué
Lackiert

Piano
Top
Plateau
Tischplatte



-G1
Bianco/White/Blanc/Weiß

Tessuti
Fabrics
Tissus
Textilien

Cuscino
Cushion
Coussin
Sitzkissen



- T3
8009
Jet, Fidivi

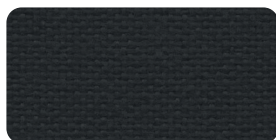

- T4
8033
Jet, Fidivi



-T7
213
Divina MD, Kvadrat



-T12
7041
Jet, Fidivi

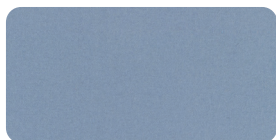

- T18
701
Hero, Kvadrat



- T24
462
Mirage, Pugi · PG



-T31
133
Mirage, Pugi · PG

Pannello esterno
External panel
Panneau extérieur
Außenpaneel



- T3
8009
Jet, Fidivi

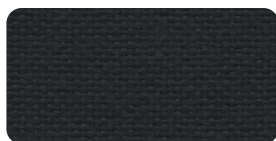

- T4
8033
Jet, Fidivi



-T7
213
Divina MD, Kvadrat

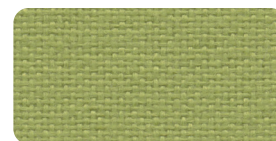

-T12
7041
Jet, Fidivi

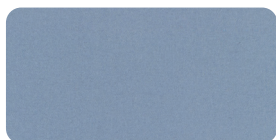

- T18
701
Hero, Kvadrat



- T24
462
Mirage, Pugi · PG



-T31
133
Mirage, Pugi · PG

DotBox

MADE IN ITALY

Unità con due cassetti V1  bianco RAL 9010 art.6D0100020 S711
L 800 x P 410 x H 400/413 mm V2  tortora RAL 7044 art.6D0100020 7044

DESIGNER Hangar Design Group

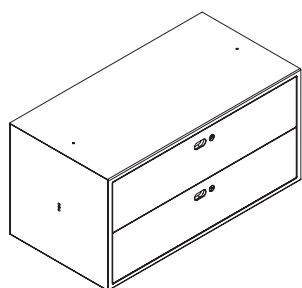

Fronte

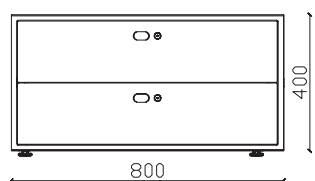

Fianco

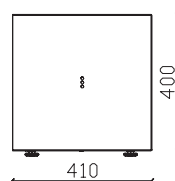

Retro

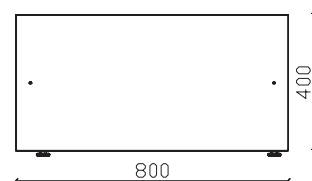

Dettaglio Piede

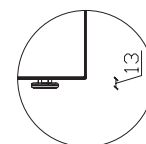

DotBox

MADE IN ITALY

Unità con due cassettei

L 800 x P 410 x H 400/413 mm

DESIGNER Hangar Design Group

DESCRIZIONE Sistema modulare

DIMENSIONI L 800 mm x P 410 mm x H 400/413 mm

ESTERNE

DIMENSIONI Casseti L 685 mm x P 310 mm x H 72 mm

INTERNE VANO

DOX Non previsto

PRODUZIONE > Dieffebi S.p.a.
> Inizio produzione: anno 2013
> Luogo di produzione: Italia

MANUTENZIONE > Pulire con panno morbido.
> Non trattare le superfici con panni abrasivi.

MATERIALI > struttura: in metallo riciclato e riciclabile

FINITURA > Verniciatura a polveri basso emissive (materiale inerte)
> Esenti da metalli pesanti
> Assenza di spigoli vivi e bordi taglienti
> Finitura anti riflesso
> Non contiene VOC

COMPONENTI STANDARD > Maniglia in materiale plastico verniciato con colore di serie grigio antracite RAL 7021
> Serratura a cilindro con due chiavi (fissa + pieghevole), 2 chiusure indipendenti e cilindro estraibile
> Disponibile chiave master su richiesta
> Guide: nascoste a scorrimento ammortizzato ad estrazione parziale
> Contrappeso non incluso
> Piedini in Nylon 13mmH
> Viti per fissaggio tra moduli

COLORI > Disponibile in 2 colori standard
> Colori standard semilucidi
> Colori personalizzabili su richiesta previa disponibilità e con sovrapprezzo:
www.dieffebi.com/docs/299/2832/DFB_Colour-Chart-2020.pdf
www.dieffebi.com/it/news

ACCESSORI > Top in vetro laccato bianco RAL 9010
> Maniglia in materiale plastico verniciato disponibile in 5 colori
> Pannelli esterni in tessuto disponibile in 7 colori standard: verde, grigio, nero, azzurro, beige chiaro, arancio, giallo
> Pannello esterno in legno
> Fissaggio pannelli: con adesivo
> Cuscini in tessuto ignifugo classe M1 disponibili in 7 colori standard: verde, grigio, nero, azzurro, beige chiaro, arancio, giallo
> Piedini cromati livellatori h 110 mm
> 4 Ruote piroettanti da ø 65 mm - con freno
> 4 Ruote piroettanti da ø 65 mm - senza freno
> Contrappeso

PESO NETTO 32,50 Kg

IMBALLO > volume: 0,19 m³
> In cartone riciclato e riciclabile
> Multiplo su pallet
> Ottimizzato per il trasporto con riduzione di CO₂
> Fornito: Montato
> N°colli: 1

END OF USE > Corredato di scheda di disassemblaggio per smaltimento.

GARANZIA > Dieffebi garantisce che il prodotto è stato realizzato usando materiali di alta qualità - Vedi documento di garanzia.

DotBox

MADE IN ITALY

Unità con due cassetti
L 800 x P 410 x H 400/413 mm

DESIGNER Hangar Design Group

BENESSERE E AMBIENTE > Design "green" in accordo con gli standard LEED®, WELL® per progettare ed arredare ambienti ad alto contenuto di sostenibilità.



www.GreenTop.com



VINCOLI ASSEMBLAGGIO > Composizioni:

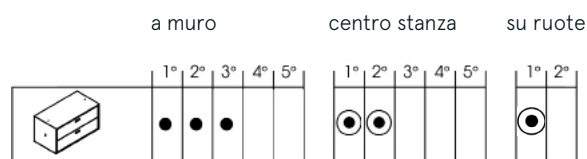

⊙ OBBLIGATORIO CONTRAPPESO INTERNO AGGIUNTO
ADDITIONAL INTERNAL COUNTER WEIGHT REQUIRED

TEST STRUTTURA > Laboratorio CATAS:

- > Ansi/bifma x5.9-2012, Clause 20
- > Ansi/bifma X5.9-2012, CLAUSE 5 (su piedini);
- > Ansi/bifma X5.9-2012, CLAUSE 11 (su ruote)

TEST FINITURA > UNI EN ISO 2409:2013 > EN ISO 1520:2006
> NSS UNI EN ISO 9227:2017 > UNI 9300:2015
> UNI EN 15187:2007 > UNI EN ISO 6272-1:2013
> EN 12720:2013 > UNI EN 15185:2011
> EN 12721:2013 > UNI EN 15186:2012, met.B
> UNI 9429:2015

CLASSE DI REAZIONE AL FUOCO > Classe 0

POSIZIONAMENTO > Sia a muro che in centro stanza

MODULARITÀ > Verticale e orizzontale

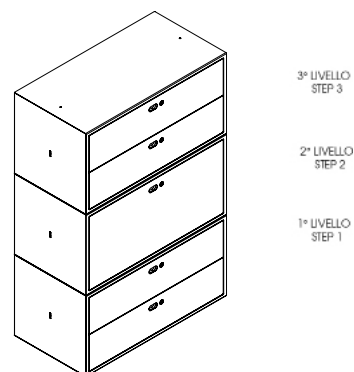

3° LIVELLO
STEP 3

2° LIVELLO
STEP 2

1° LIVELLO
STEP 1



dieffebi



MADE IN EUROPE



ASSUFFICIO
ASSOCIAZIONE FIDELIENGINARRECCI

ADIMEMBER



consip
acquistinretepa.it
Il Fornitore Aggiuntivo della Pubblica Amministrazione

DotBox

MADE IN ITALY

Vernici
Varnish
Vernis
Lacke

Corpo
Cabinet Body
Caisson
Korpus

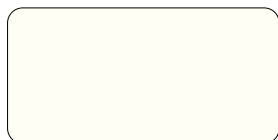

-V1
S711 (RAL 9010)
Pure white



-V2
7044 (RAL 7044)
Silk grey

Maniglie
Handles
Poignées
Griffe



-V8
6013 (RAL 6013)
Reed green



-V15
1021 (RAL 1021)
Rape yellow



-V17
5024 (RAL 5024)
Pastel blue



-V24
3005 (RAL 3005)
Wine red

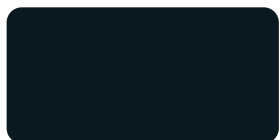

-V19
S210 (RAL 7021)
Black grey

Legno
Wood
Bois
Holz

Pannello esterno in legno
External wooden panel
Panneau extérieur en bois
Außenpaneel aus Holz



-W2
Castagno chiaro
/Light chestnut
/Châtaignier clair
/Kastanienholz hell

DotBox

MADE IN ITALY

Vetro
Glass
Verre
Glas

Laccato
Lacquer
Laqué
Lackiert

Piano
Top
Plateau
Tischplatte



-G1
Bianco/White/Blanc/Weiß

Tessuti
Fabrics
Tissus
Textilien

Cuscino
Cushion
Coussin
Sitzkissen



- T3
8009
Jet, Fidivi

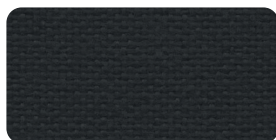

- T4
8033
Jet, Fidivi



-T7
213
Divina MD, Kvadrat



-T12
7041
Jet, Fidivi

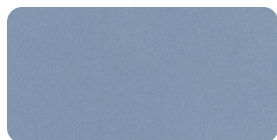

- T18
701
Hero, Kvadrat



- T24
462
Mirage, Pugi · PG



-T31
133
Mirage, Pugi · PG

Pannello esterno
External panel
Panneau extérieur
Außenpaneel



- T3
8009
Jet, Fidivi

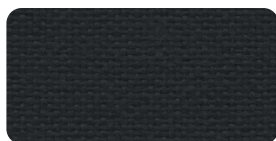

- T4
8033
Jet, Fidivi



-T7
213
Divina MD, Kvadrat

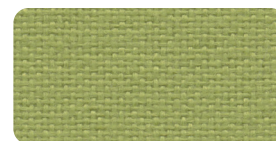

-T12
7041
Jet, Fidivi

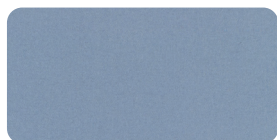

- T18
701
Hero, Kvadrat

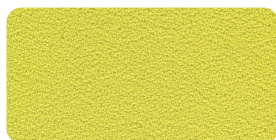

- T24
462
Mirage, Pugi · PG





-T31
133
Mirage, Pugi · PG

DotBox

MADE IN ITALY

Unità un cassetto
e un cassetto classificatore
L 800 x P 410 x H 627 mm

V1  bianco RAL 9010 art.6D0300010 S711
V2  tortora RAL 7044 art.6D0300010 7044

DESIGNER Hangar Design Group

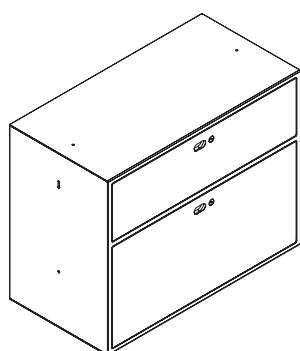

Fronte

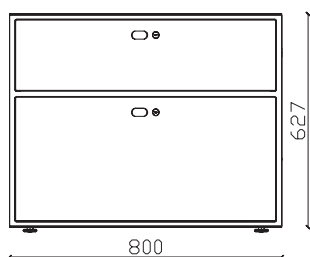

Fianco

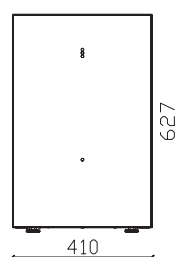

Retro

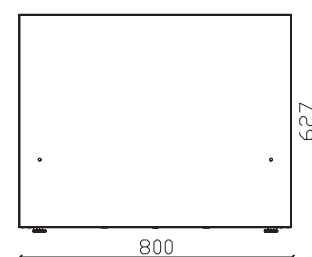

Dettaglio Piede

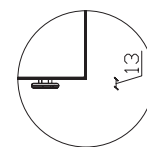

DotBox

MADE IN ITALY

Unità un cassetto
e un cassetto classificatore
L 800 x P 410 x H 627 mm

DESIGNER Hangar Design Group

DESCRIZIONE	Sistema modulare
DIMENSIONI ESTERNE	L 800 mm x P 410 mm x H 627 mm
DIMENSIONI INTERNE VANI	Cassetto L 685 mm x P 310 mm x H 72 mm Cassetto Class. L 685 mm x P 325 mm x H 283 mm
CARTELLINE	Capienza N° 45 Cartelline da 330 mm in verticale Capienza N° 40 Cartelline da 330 mm in orizzontale
PRODUZIONE	> Dieffebi S.p.a. > Inizio produzione: anno 2013 > Luogo di produzione: Italia
MANUTENZIONE	> Pulire con panno morbido. > Non trattare le superfici con panni abrasivi.
MATERIALI	> struttura: in metallo riciclato e riciclabile
FINITURA	> Verniciatura a polveri basso emissive (materiale inerte) > Esenti da metalli pesanti > Assenza di spigoli vivi e bordi taglienti > Finitura anti riflesso > Non contiene VOC
COMPONENTI STANDARD	> Cassetto classificatore: completamente chiuso dotato di cavalieri porta cartelle predisposto per cartelle sospese. > Maniglia in materiale plastico verniciato con colore di serie grigio antracite RAL 7021. > Serratura a cilindro: con due chiavi (fissa + pieghevole), 2 chiusure indipendenti e cilindro estraibile > Disponibile chiave master su richiesta > Guide: nascoste a scorrimento ammortizzato ad estrazione parziale e totale > Piedini in Nylon 13mmH > Contrappeso non incluso > Viti per fissaggio tra moduli

COLORI	> Disponibile in 2 colori standard > Colori standard semilucidi > Colori personalizzabili su richiesta previa disponibilità e con sovrapprezzo: www.dieffebi.com/docs/299/2832/DFB_Colour-Chart-2020.pdf www.dieffebi.com/it/news
ACCESSORI	> Top in vetro laccato bianco RAL 9010 > Maniglia in materiale plastico verniciato disponibile in 5 colori > Pannelli esterni in tessuto disponibile in 7 colori standard: verde, grigio, nero, azzurro, beige chiaro, arancio, giallo > Pannello esterno in legno > Fissaggio pannelli: con adesivo > Cuscini in tessuto ignifugo classe M1 disponibili in 7 colori standard: verde, grigio, nero, azzurro, beige chiaro, arancio, giallo > Piedini cromati livellatori h 110 mm > 4 Ruote piroettanti da ø 65 mm - con freno > 4 Ruote piroettanti da ø 65 mm - senza freno > Contrappeso
PESO NETTO	44,00 Kg
IMBALLO	> volume: 0,28 m ³ > In cartone riciclato e riciclabile > Multiplo su pallet > Ottimizzato per il trasporto con riduzione di CO2 > Fornito: Montato > N°colli: 1
END OF USE	> Corredato di scheda di disassemblaggio per smaltimento.
GARANZIA	> Dieffebi garantisce che il prodotto è stato realizzato usando materiali di alta qualità - Vedi documento di garanzia.

DotBox

MADE IN ITALY

Unità un cassetto
e un cassetto classificatore
L 800 x P 410 x H 627 mm

DESIGNER Hangar Design Group

BENESSERE E AMBIENTE > Design "green" in accordo con gli standard LEED®, per progettare ed arredare ambienti ad alto contenuto di sostenibilità.



www.GreenTop.com



VINCOLI ASSEMBLAGGIO > Composizioni:

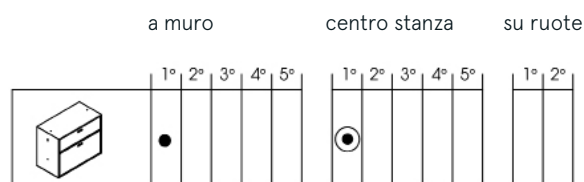

● OBBLIGATORIO CONTRAPPESO INTERNO AGGIUNTO
ADDITIONAL INTERNAL COUNTER WEIGHT REQUIRED

TEST STRUTTURA > Laboratorio CATAS
ANSI/BIFMA X5.9-2012, CLAUSE 20

TEST FINITURA > UNI EN ISO 2409:2013 > EN ISO 1520:2006
> NSS UNI EN ISO 9227:2017 > UNI 9300:2015
> UNI EN 15187:2007 > UNI EN ISO 6272-1:2013
> EN 12720:2013 > UNI EN 15185:2011
> EN 12721:2013 > UNI EN 15186:2012, met.B
> UNI 9429:2015

CLASSE DI > Classe 0

REAZIONE AL FUOCO

POSIZIONAMENTO > Sia a muro che in centro stanza

MODULARITÀ > Verticale e orizzontale

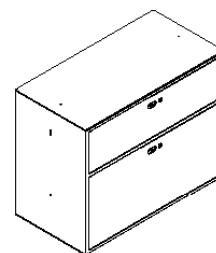

1° LIVELLO
STEP 1



dieffebi



MADE IN EUROPE



ASSUFFICIO
ASSOCIAZIONE FIDELIENSDARRECO

ADIMEMBER



consip
acquistinretepa.it
Il Portale degli Appalti della Pubblica Amministrazione

DotBox

MADE IN ITALY

Vernici
Varnish
Vernis
Lacke

Corpo
Cabinet Body
Caisson
Korpus

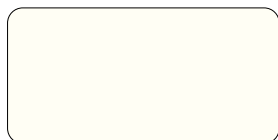

-V1
S711 (RAL 9010)
Pure white



-V2
7044 (RAL 7044)
Silk grey

Maniglie
Handles
Poignées
Griffe



-V8
6013 (RAL 6013)
Reed green



-V15
1021 (RAL 1021)
Rape yellow



-V17
5024 (RAL 5024)
Pastel blue



-V24
3005 (RAL 3005)
Wine red



-V19
S210 (RAL 7021)
Black grey

Vetro
Glass
Verre
Glas

Laccato
Lacquer
Laqué
Lackiert

Piano
Top
Plateau
Tischplatte



-G1
Bianco/White/Blanc/Weiß

DotBox

MADE IN ITALY

Tessuti
Fabrics
Tissus
Textilien

Cuscino
Cushion
Coussin
Sitzkissen

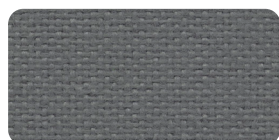

— T3
8009
Jet, Fidivi

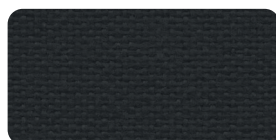

— T4
8033
Jet, Fidivi



— T7
213
Divina MD, Kvadrat

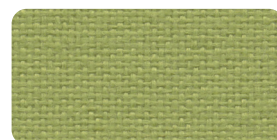

— T12
7041
Jet, Fidivi



— T18
701
Hero, Kvadrat

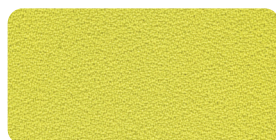

— T24
462
Mirage, Pugi · PG



— T31
133
Mirage, Pugi · PG

Pannello esterno
External panel
Panneau extérieur
Außenpaneel



— T3
8009
Jet, Fidivi

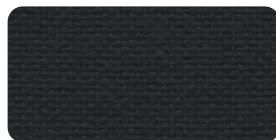

— T4
8033
Jet, Fidivi



— T7
213
Divina MD, Kvadrat

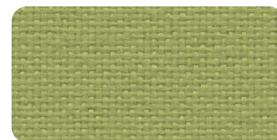

— T12
7041
Jet, Fidivi

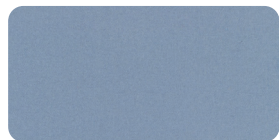

— T18
701
Hero, Kvadrat



— T24
462
Mirage, Pugi · PG



— T31
133
Mirage, Pugi · PG