



DotBox

MADE IN ITALY

Filing drawer unit
 W 800 x D 410 x H 400/413 mm

V1  white RAL 9010 art.6D0100010 S711
 V2  silk grey RAL 7044 art.6D0100010 7044

DESIGNER Hangar Design Group

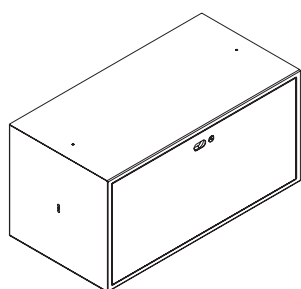

Front

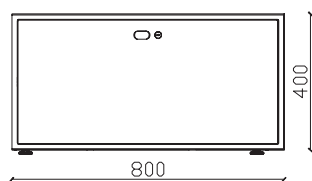

Side

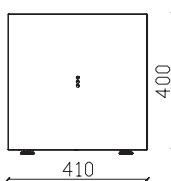

Back

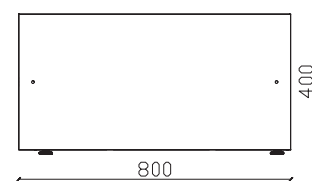

Feet detail

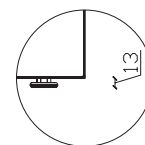

DotBox

MADE IN ITALY

Filing drawer unit

W 800 x D 410 x H 400/413 mm

DESIGNER Hangar Design Group

DESCRIPTION	Modular system
EXTERNAL DIMENSIONS	W 800 mm x D 410 mm x H 400/413 mm
INTERNAL DIMENSIONS	Filing drawer W 685 mm x D 325 mm x H 283 mm
HANGING FILES	Capacity N ° 45 of 330 mm vertically Capacity N ° 40 of 330 mm horizontally
PRODUCTION	> Dieffebi S.p.a. > Start of production: 2013 > Country of production: Italy
MAINTENANCE	> Clean with a soft cloth > Do not treat the surfaces with abrasive cloths
MATERIALS	> Structure made of recycled and recyclable metal
FINISHING	> Low-emission powder coating (material inert) > Free from heavy metals > Absence of sharp edges and cutting edges > Anti-glare finish > It does not contain VOCs
STANDARD COMPONENTS	> Filing drawer: equipped with file holders designed for hanging files > Handle in plastic material painted with the standard color anthracite gray RAL 7021 > Cylinder lock with two keys (fixed + folding), central locking and removable cylinder > Master key available on request > Guides: hidden with amortized sliding and full extension > Nylon feet H 13mm > Screws for fixing between modules

COLORS	> Available in 2 standard colors > Standard semi-gloss colors > Customizable colors available upon request and with an extra charge www.dieffebi.com/docs/299/2832/DFB_Colour-Chart-2020.pdf www.dieffebi.com/it/news
ACCESSORIES	> White lacquered glass top RAL 9010 > Painted plastic handle available in 5 colors > External fabric panels available in 7 standard colors: green, gray, black, blue, light beige, orange, yellow > External wooden panel > Panel fixing: with adhesive > Cushions in M1 class fireproof fabric available in 7 standard colors: green, gray, black, light blue, light beige, orange, yellow > Chromed leveling feet h 110 mm > Set of 4 castors without brake - ø 65 mm > Set of 4 castors with brake - ø 65 mm > Counterweight
NET WEIGHT	30,50 Kg
PACKAGING	> volume: 0,19 m ³ > recycled and recyclable cardboard > Multiple on pallets > Optimized for transport with CO2 reduction > Supplied: Assembled > No. of packages: 1
END OF USE	> Equipped with disassembly card for disposal
WARRANTY	> Dieffebi guarantees that the product was made using high quality materials - See warranty document

DotBox

MADE IN ITALY

Filing drawer unit
W 800 x D 410 x H 400/413 mm

DESIGNER Hangar Design Group

WELLNESS AND
ENVIRONMENT

> Green design in accordance with LEED® standards, to design and furnish environments with a high sustainability content



www.GreenTop.com

STRUCTURE TEST

> CATAS laboratory
ANSI/BIFMA X5.9-2012, CLAUSE 20

METAL TEST

> UNI EN ISO 2409:2013 > EN ISO 1520:2006
> NSS UNI EN ISO 9227:2017 > UNI 9300:2015
> UNI EN 15187:2007 > UNI EN ISO 6272-1:2013
> EN 12720:2013 > UNI EN 15185:2011
> EN 12721:2013 > UNI EN 15186:2012, met.B
> UNI 9429:2015

CLASS OF

> Class 0

REACTION TO
FIRE

POSITIONING

> Both on the wall and in the center of the room

MODULARITY

> Vertical and horizontal

ASSEMBLY
CONSTRAINTS

> Compositions:

on the wall center of the room on wheels

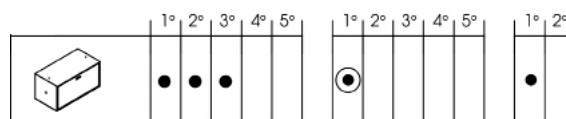

● OBBLIGATORIO CONTRAPPESO INTERNO AGGIUNTO
ADDITIONAL INTERNAL COUNTER WEIGHT REQUIRED

> Composition: example of wall composition

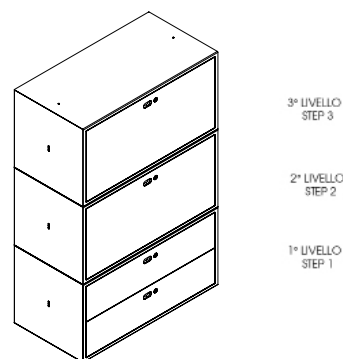

dieffebi



MADE IN EUROPE



ASSUFFICIO
ASSOCIAZIONE FIDELIENSDARRECO

ADIMEMBER



consip
acquistinretepa.it
Il Fornitore Aggiunto della Pubblica Amministrazione

Dieffebi SpA

via Palù 36
San Vendemiano,
31020 Treviso - Italia

T +39 0438 4715
F +39 0438 471600
exportsales@dieffebi.com
vendite@dieffebi.com
www.dieffebi.com

DotBox

MADE IN ITALY

Varnish
Vernici
Vernis
Lacke

Cabinet Body
Corpo
Caisson
Korpus

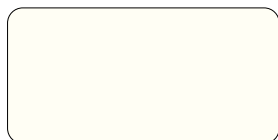

-V1
S711 (RAL 9010)
Pure white



-V2
7044 (RAL 7044)
Silk grey

Handles
Maniglie
Poignées
Griffe



-V8
6013 (RAL 6013)
Reed green



-V15
1021 (RAL 1021)
Rape yellow



-V17
5024 (RAL 5024)
Pastel blue



-V24
3005 (RAL 3005)
Wine red

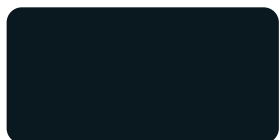

-V19
S210 (RAL 7021)
Black grey

Wood
Legno
Bois
Holz

External wooden panel
Pannello esterno in legno
Panneau extérieur en bois
Außenpaneel aus Holz



-W2
Castagno chiaro
/Light chestnut
/Châtaignier clair
/Kastanienholz hell

DotBox

MADE IN ITALY

Glass
Vetro
Verre
Glas

Lacquer
Laccato
Laqué
Lackiert

Top
Piano
Plateau
Tischplatte



-G1
Bianco/White/Blanc/Weiß

Fabrics
Tessuti
Tissus
Textilien

Cushion
Cuscino
Coussin
Sitzkissen



- T3
8009
Jet, Fidivi

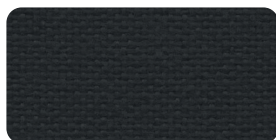

- T4
8033
Jet, Fidivi



-T7
213
Divina MD, Kvadrat



-T12
7041
Jet, Fidivi

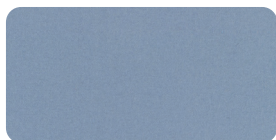

- T18
701
Hero, Kvadrat



- T24
462
Mirage, Pugi · PG



-T31
133
Mirage, Pugi · PG

External panel
Pannello esterno
Panneau extérieur
Außenpaneel



- T3
8009
Jet, Fidivi

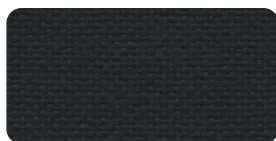

- T4
8033
Jet, Fidivi



-T7
213
Divina MD, Kvadrat

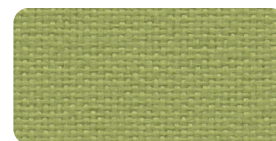

-T12
7041
Jet, Fidivi

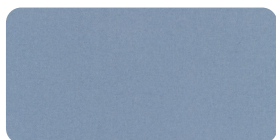

- T18
701
Hero, Kvadrat



- T24
462
Mirage, Pugi · PG



-T31
133
Mirage, Pugi · PG

DotBox

MADE IN ITALY

2 drawer unit

V1  white RAL 9010 art.6D0100020 S711

W 800 x D 410 x H 400/413 mm

V2  silk grey RAL 7044 art.6D0100020 7044

DESIGNER Hangar Design Group

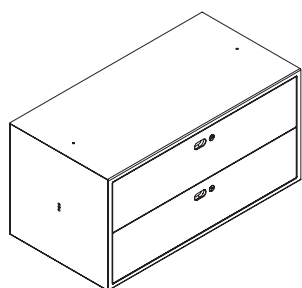

Front

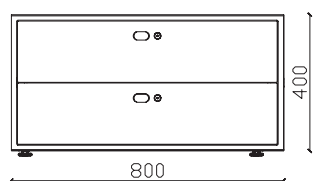

Side

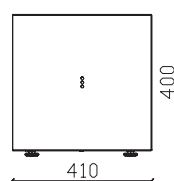

Back

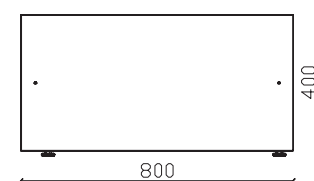

Feet detail

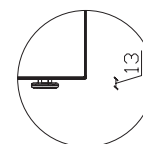

DotBox

MADE IN ITALY

2 drawer unit

W 800 x D 410 x H 400/413 mm

DESIGNER Hangar Design Group

DESCRIPTION	Modular system
EXTERNAL DIMENSIONS	W 800 mm x D 410 mm x H 400/413 mm
INTERNAL DIMENSIONS	Drawers W 685 mm x D 310 mm x H 72 mm
PRODUCTION	<ul style="list-style-type: none"> > Dieffebi S.p.a. > Start of production: 2013 > Country of production: Italy
MAINTENANCE	<ul style="list-style-type: none"> > Clean with a soft cloth > Do not treat the surfaces with abrasive cloths
MATERIALS	> Structure made of recycled and recyclable metal
FINISHING	<ul style="list-style-type: none"> > Low-emission powder coating (material inert) > Free from heavy metals > Absence of sharp edges and cutting edges > Anti-glare finish > It does not contain VOCs
STANDARD COMPONENTS	<ul style="list-style-type: none"> > Handle in plastic material painted with the standard color anthracite gray RAL 7021 > Cylinder lock: with two keys (fixed + folding), 2 independent locks and removable cylinder > Master key available on request > Guides: hidden with soft-close sliding and partial extraction > Counterweight not included > Nylon feet H 13mm > Screws for fixing between modules

COLORS	<ul style="list-style-type: none"> > Available in 2 standard colors > Standard semi-gloss colors > Customizable colors available upon request and with an extra charge <p>www.dieffebi.com/docs/299/2832/DFB_Colour-Chart-2020.pdf</p> <p>www.dieffebi.com/it/news</p>
---------------	--

ACCESSORIES	<ul style="list-style-type: none"> > White lacquered glass top RAL 9010 > Painted plastic handle available in 5 colors > External fabric panels available in 7 standard colors: green, gray, black, blue, light beige, orange, yellow > External wooden panel > Panel fixing: with adhesive > Cushions in M1 class fireproof fabric available in 7 standard colors: green, gray, black, light blue, light beige, orange, yellow > Chromed leveling feet h 110 mm > Set of 4 castors without brake - ø 65 mm > Set of 4 castors with brake - ø 65 mm > Counterweight
--------------------	---

NET WEIGHT	32,50 Kg
-------------------	----------

PACKAGING	<ul style="list-style-type: none"> > volume: 0,19 m³ > recycled and recyclable cardboard > Multiple on pallets > Optimized for transport with CO2 reduction > Supplied: Assembled > No. of packages: 1
------------------	---

END OF USE	> Equipped with disassembly card for disposal
-------------------	---

WARRANTY	> Dieffebi guarantees that the product was made using high quality materials - See warranty document
-----------------	--

DotBox

MADE IN ITALY

2 drawer unit
W 800 x D 410 x H 400/413 mm

DESIGNER Hangar Design Group

WELLNESS AND ENVIRONMENT > Green design in accordance with LEED® standards, to design and furnish environments with a high sustainability content



www.GreenTop.com



ASSEMBLY CONSTRAINTS > Compositions:

on the wall center of the room on wheels

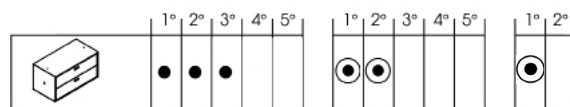

OBBLIGATORIO CONTRAPPESO INTERNO AGGIUNTO
ADDITIONAL INTERNAL COUNTER WEIGHT REQUIRED

> Composition: example of wall composition

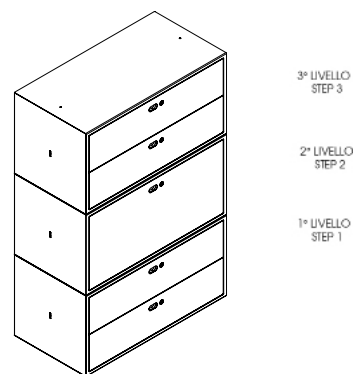

STRUCTURE TEST > CATAS laboratory
> Ansi/bifma x5.9-2012, Clause 20
> Ansi/bifma X5.9-2012, CLAUSE 5 (on feet);
> Ansi/bifma X5.9-2012, CLAUSE 11 (on wheels)

METAL TEST > UNI EN ISO 2409:2013 > EN ISO 1520:2006
> NSS UNI EN ISO 9227:2017 > UNI 9300:2015
> UNI EN 15187:2007 > UNI EN ISO 6272-1:2013
> EN 12720:2013 > UNI EN 15185:2011
> EN 12721:2013 > UNI EN 15186:2012, met.B
> UNI 9429:2015

CLASS OF REACTION TO FIRE > Class 0

POSITIONING > Both on the wall and in the center of the room

MODULARITY > Vertical and horizontal



dieffebi



MADE IN EUROPE

ASSUFFICIO
ASSOCIAZIONE FIDELIENGINARRECCI

ADIMEMBER

consip
acquistinretepa.it
Il Fornitore Aggiuntivo della Pubblica Amministrazione

DotBox

MADE IN ITALY

Varnish
Vernici
Vernis
Lacke

Cabinet Body
Corpo
Caisson
Korpus



-V1
S711 (RAL 9010)
Pure white



-V2
7044 (RAL 7044)
Silk grey

Handles
Maniglie
Poignées
Griffe



-V8
6013 (RAL 6013)
Reed green



-V15
1021 (RAL 1021)
Rape yellow



-V17
5024 (RAL 5024)
Pastel blue



-V24
3005 (RAL 3005)
Wine red

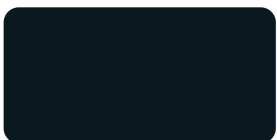

-V19
S210 (RAL 7021)
Black grey

Wood
Legno
Bois
Holz

External wooden panel
Pannello esterno in legno
Panneau extérieur en bois
Außenpaneel aus Holz



- W2
Castagno chiaro
/Light chestnut
/Châtaignier clair
/Kastanienholz hell

DotBox

MADE IN ITALY

Glass
Vetro
Verre
Glas

Lacquer
Laccato
Laqué
Lackiert

Top
Piano
Plateau
Tischplatte



-G1
Bianco/White/Blanc/Weiß

Fabrics
Tessuti
Tissus
Textilien

Cushion
Cuscino
Coussin
Sitzkissen



- T3
8009
Jet, Fidivi

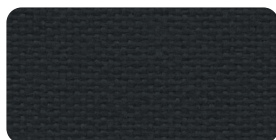

- T4
8033
Jet, Fidivi



-T7
213
Divina MD, Kvadrat



-T12
7041
Jet, Fidivi

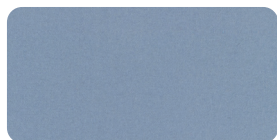

- T18
701
Hero, Kvadrat



- T24
462
Mirage, Pugi · PG



-T31
133
Mirage, Pugi · PG

External panel
Pannello esterno
Panneau extérieur
Außenpaneel



- T3
8009
Jet, Fidivi

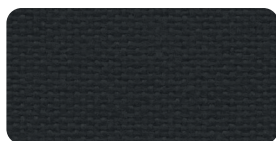

- T4
8033
Jet, Fidivi



-T7
213
Divina MD, Kvadrat

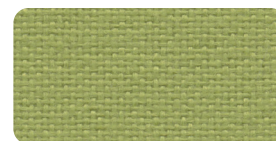

-T12
7041
Jet, Fidivi

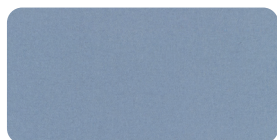

- T18
701
Hero, Kvadrat



- T24
462
Mirage, Pugi · PG





-T31
133
Mirage, Pugi · PG

DotBox

MADE IN ITALY

1 drawer
+ 1 filing drawer unit
W 800 x D 410 x H 627 mm

V1  white RAL 9010 art.6D0300010 S711
V2  silk grey RAL 7044 art.6D0300010 7044

DESIGNER Hangar Design Group

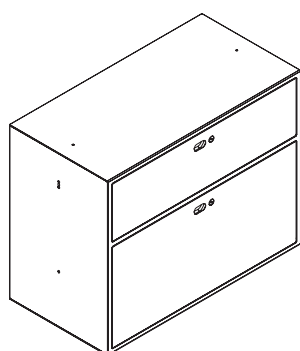

Front

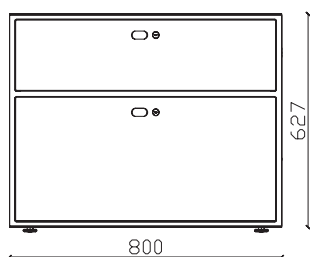

Side

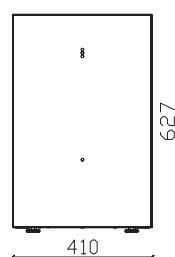

Back

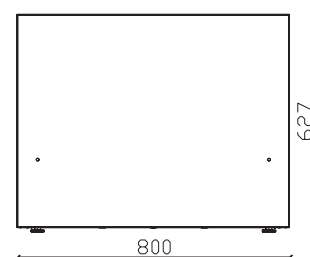

Feet detail

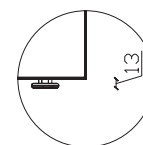

DotBox

MADE IN ITALY

1 drawer
+ 1 filing drawer unit
W 800 x D 410 x H 627 mm

DESIGNER Hangar Design Group

DESCRIPTION	Modular system
EXTERNAL DIMENSIONS	W 800 mm x D 410 mm x H 627 mm
INTERNAL DIMENSIONS	Drawers W 685 mm x D 310 mm x H 72 mm Filing drawer W 685 mm x D 325 mm x H 283 mm
HANGING FILES	Capacity N ° 45 filing drawer of 330 mm vertically Capacity N ° 40 filing drawer of 330 mm horizontally
PRODUCTION	> Dieffebi S.p.a. > Start of production: 2013 > Country of production: Italy
MAINTENANCE	> Clean with a soft cloth > Do not treat the surfaces with abrasive cloths
MATERIALS	> Structure made of recycled and recyclable metal
FINISHING	> Low-emission powder coating (material inert) > Free from heavy metals > Absence of sharp edges and cutting edges > Anti-glare finish > It does not contain VOCs
STANDARD COMPONENTS	> Filing drawer: completely closed equipped with prearranged folder holders for hanging files > Handle in plastic material painted with the standard color anthracite gray RAL 7021 > Cylinder lock: with two keys (fixed + folding), 2 independent locks and removable cylinder > Master key available on request > Guides: hidden with soft-close sliding and partial extraction > Nylon feet H 13mm > Counterweight not included > Screws for fixing between modules

COLORS	> Available in 2 standard colors > Standard semi-gloss colors > Customizable colors available upon request and with an extra charge www.dieffebi.com/docs/299/2832/DFB_Colour-Chart-2020.pdf www.dieffebi.com/it/news
ACCESSORIES	> White lacquered glass top RAL 9010 > Painted plastic handle available in 5 colors > External fabric panels available in 7 standard colors: green, gray, black, blue, light beige, orange, yellow > External wooden panel > Panel fixing: with adhesive > Cushions in M1 class fireproof fabric available in 7 standard colors: green, gray, black, light blue, light beige, orange, yellow > Chromed leveling feet h 110 mm > Set of 4 castors without brake - ø 65 mm > Set of 4 castors with brake - ø 65 mm > Counterweight
NET WEIGHT	44,00 Kg
PACKAGING	> volume: 0,28 m ³ > recycled and recyclable cardboard > Multiple on pallets > Optimized for transport with CO2 reduction > Supplied: Assembled > No. of packages: 1
END OF USE	> Equipped with disassembly card for disposal
WARRANTY	> Dieffebi guarantees that the product was made using high quality materials - See warranty document

DotBox

MADE IN ITALY

1 drawer
+ 1 filing drawer unit
W 800 x D 410 x H 627 mm

DESIGNER Hangar Design Group

WELLNESS AND ENVIRONMENT > Green design in accordance with LEED® standards, to design and furnish environments with a high sustainability content



www.GreenTop.com



ASSEMBLY CONSTRAINTS > Compositions:

on the wall center of the room on wheels

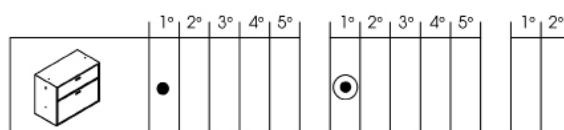

● OBBLIGATORIO CONTRAPPESO INTERNO AGGIUNTO
ADDITIONAL INTERNAL COUNTER WEIGHT REQUIRED

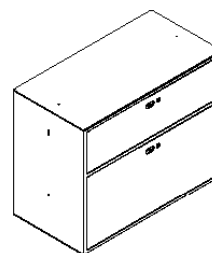

1° LIVELLO
STEP 1

STRUCTURE TEST > CATAS laboratory
ANSI/BIFMA X5.9-2012, CLAUSE 20

METAL TEST > UNI EN ISO 2409:2013 > EN ISO 1520:2006
> NSS UNI EN ISO 9227:2017 > UNI 9300:2015
> UNI EN 15187:2007 > UNI EN ISO 6272-1:2013
> EN 12720:2013 > UNI EN 15185:2011
> EN 12721:2013 > UNI EN 15186:2012, met.B
> UNI 9429:2015

CLASS OF REACTION TO FIRE > Class 0

POSITIONING > Both on the wall and in the center of the room

MODULARITY > Vertical and horizontal



dieffebi



MADE IN EUROPE



ASSUFFICIO
ASSOCIAZIONE FIDELIENSDARRECO

ADIMEMBER



consip
acquistinretepa.it
Il Fornitore Aggiuntivo della Pubblica Amministrazione

Dieffebi SpA

via Palù 36
San Vendemiano,
31020 Treviso - Italia

T +39 0438 4715
F +39 0438 471600
exportsales@dieffebi.com
vendite@dieffebi.com
www.dieffebi.com

DotBox

MADE IN ITALY

Varnish
Vernici
Vernis
Lacke

Cabinet Body
Corpo
Caisson
Korpus

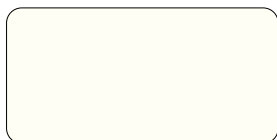

-V1
S711 (RAL 9010)
Pure white



-V2
7044 (RAL 7044)
Silk grey

Handles
Maniglie
Poignées
Griffe



-V8
6013 (RAL 6013)
Reed green



-V15
1021 (RAL 1021)
Rape yellow



-V17
5024 (RAL 5024)
Pastel blue



-V24
3005 (RAL 3005)
Wine red

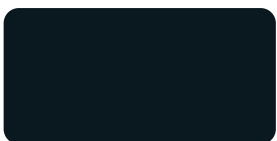

-V19
S210 (RAL 7021)
Black grey

Glass
Vetro
Verre
Glas

Lacquer
Laccato
Laqué
Lackiert

Top
Piano
Plateau
Tischplatte

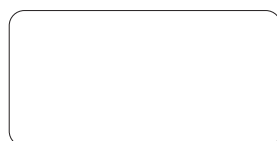

-G1
Bianco/White/Blanc/Weiß

DotBox

MADE IN ITALY

Fabrics
Tessuti
Tissus
Textilien

Cushion
Cuscino
Coussin
Sitzkissen



– T3
8009
Jet, Fidivi

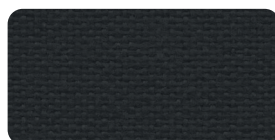

– T4
8033
Jet, Fidivi



–T7
213
Divina MD, Kvadrat

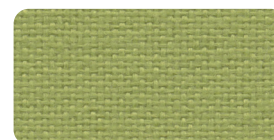

–T12
7041
Jet, Fidivi



– T18
701
Hero, Kvadrat

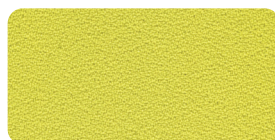

– T24
462
Mirage, Pugi · PG



–T31
133
Mirage, Pugi · PG

External panel
Pannello esterno
Panneau extérieur
Außenpaneel



– T3
8009
Jet, Fidivi

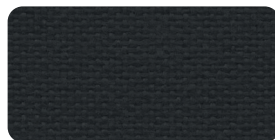

– T4
8033
Jet, Fidivi



–T7
213
Divina MD, Kvadrat



–T12
7041
Jet, Fidivi

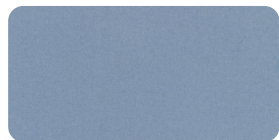

– T18
701
Hero, Kvadrat



– T24
462
Mirage, Pugi · PG



–T31
133
Mirage, Pugi · PG

DotBox

MADE IN ITALY

Pedestal V1  white RAL 9010 art.6DB00010P S711
 W 400 x D 410 x H 400/413 mm V2  silk grey RAL 7044 art.6DB00010P 7044

DESIGNER Hangar Design Group

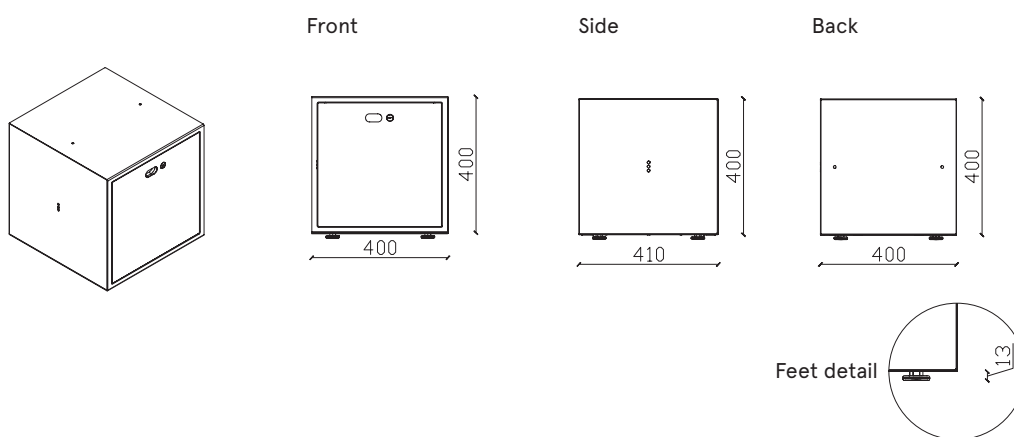

DotBox

MADE IN ITALY

Pedestal

W 400 x D 410 x H 400/413 mm

DESIGNER Hangar Design Group

DESCRIPTION	Modular system
EXTERNAL DIMENSIONS	W 400 mm x D 410 mm x H 400/413 mm
INTERNAL DIMENSIONS	Filing drawer W 285 mm x D 325 mm x H 255 mm
BINDERS	N°8 h 320 mm
HANGING FILES	Capacity N ° 22 hanging files of 330 mm vertically
PRODUCTION	<ul style="list-style-type: none"> > Dieffebi S.p.a. > Start of production: 2013 > Country of production: Italy
MAINTENANCE	<ul style="list-style-type: none"> > Clean with a soft cloth > Do not treat the surfaces with abrasive cloths
MATERIALS	> Structure made of recycled and recyclable metal
FINISHING	<ul style="list-style-type: none"> > Low-emission powder coating (material inert) > Free from heavy metals > Absence of sharp edges and cutting edges > Anti-glare finish > It does not contain VOCs
STANDARD COMPONENTS	<ul style="list-style-type: none"> > Handle in plastic material painted with the standard color anthracite gray RAL 7021 > Cylinder lock with two keys (fixed + folding), central locking and removable cylinder > Master key available on request > Guides: hidden with amortized sliding and full extension > Filing drawer: equipped with file holders designed for hanging files > Counterweight included > Nylon feet H 13mm > Screws for fixing between modules

COLORS	<ul style="list-style-type: none"> > Available in 2 standard colors > Standard semi-gloss colors > Customizable colors available upon request and with an extra charge <p>www.dieffebi.com/docs/299/2832/DFB_Colour-Chart-2020.pdf</p> <p>www.dieffebi.com/it/news</p>
ACCESSORIES	<ul style="list-style-type: none"> > White lacquered glass top RAL 9010 > Painted plastic handle available in 5 colors > Cushions in M1 class fireproof fabric available in 7 standard colors: green, gray, black, light blue, light beige, orange, yellow > Chromed leveling feet h 110 mm > Set of 4 castors without brake - ø 65 mm > Set of 4 castors with brake - ø 65 mm
NET WEIGHT	27,10 Kg
PACKAGING	<ul style="list-style-type: none"> > volume: 0,10 m³ > recycled and recyclable cardboard > Multiple on pallets > Optimized for transport with CO2 reduction > Supplied: Assembled > No. of packages: 1
END OF USE	> Equipped with disassembly card for disposal
WARRANTY	> Dieffebi guarantees that the product was made using high quality materials - See warranty document

DotBox

MADE IN ITALY

Pedestal
W 400 x D 410 x H 400/413 mm

DESIGNER Hangar Design Group

WELLNESS AND ENVIRONMENT > Green design in accordance with LEED® standards, to design and furnish environments with a high sustainability content



ASSEMBLY CONSTRAINTS > Compositions:
on the wall center of the room on wheels

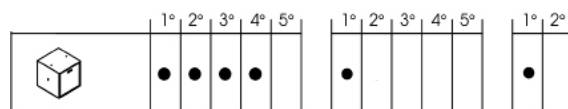

METAL TEST

- > UNI EN ISO 2409:2013 > EN ISO 1520:2006
- > NSS UNI EN ISO 9227:2017 > UNI 9300:2015
- > UNI EN 15187:2007 > UNI EN ISO 6272-1:2013
- > EN 12720:2013 > UNI EN 15185:2011
- > EN 12721:2013 > UNI EN 15186:2012, met.B
- > UNI 9429:2015

> Composition: example

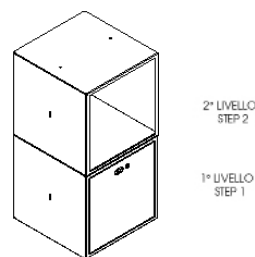

CLASS OF REACTION TO FIRE > Class 0

POSITIONING > Both on the wall and in the center of the room

MODULARITY > Vertical and horizontal



ADIMEMBER



DotBox

MADE IN ITALY

Varnish
Vernici
Vernis
Lacke

Cabinet Body
Corpo
Caisson
Korpus

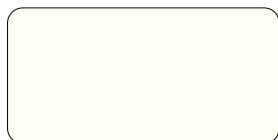

-V1
S711 (RAL 9010)
Pure white



-V2
7044 (RAL 7044)
Silk grey

Handles
Maniglie
Poignées
Griffe



-V8
6013 (RAL 6013)
Reed green



-V15
1021 (RAL 1021)
Rape yellow



-V17
5024 (RAL 5024)
Pastel blue



-V24
3005 (RAL 3005)
Wine red

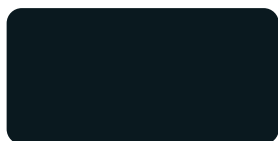

-V19
S210 (RAL 7021)
Black grey

Glass
Vetro
Verre
Glas

Lacquer
Laccato
Laqué
Lackiert

Top
Piano
Plateau
Tischplatte



-G1
Bianco/White/Blanc/Weiß

DotBox

MADE IN ITALY

Fabrics
Tessuti
Tissus
Textilien

Cushion
Cuscino
Coussin
Sitzkissen



- T3
8009
Jet, Fidivi

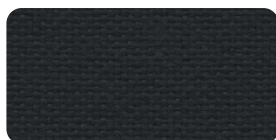

- T4
8033
Jet, Fidivi



-T7
213
Divina MD, Kvadrat



-T12
7041
Jet, Fidivi

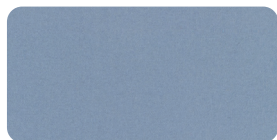

- T18
701
Hero, Kvadrat

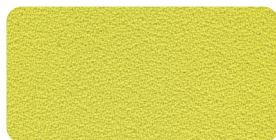

- T24
462
Mirage, Pugi · PG



-T31
133
Mirage, Pugi · PG

DotBox

MADE IN ITALY

Mobile pedestal

W 400 x D 410 x H 470 mm

V1 ○ white

V2 ● silk grey

RAL 9010

RAL 7044

art.6D0400010 S711

art.6D0400010 7044

DESIGNER Hangar Design Group

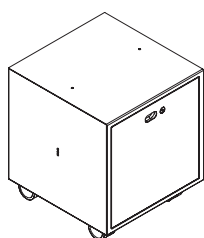

Front

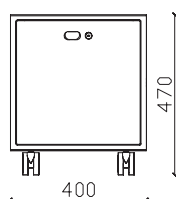

Side

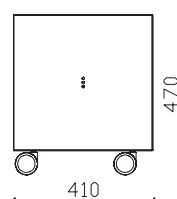

Back

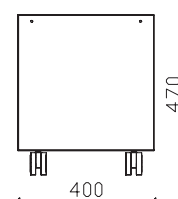

DotBox

MADE IN ITALY

Mobile pedestal

W 400 x D 410 x H 470 mm

DESIGNER Hangar Design Group

DESCRIPTION	Modular system	COLORS	<ul style="list-style-type: none"> > Available in 2 standard colors > Standard semi-gloss colors > Customizable colors available upon request and with an extra charge www.dieffebi.com/docs/299/2832/DFB_Colour-Chart-2020.pdf. www.dieffebi.com/it/news
EXTERNAL DIMENSIONS	W 400 mm x D 410 mm x H 470 mm	ACCESSORIES	<ul style="list-style-type: none"> > White lacquered glass top RAL 9010 > Painted plastic handle available in 5 colors > Cushions in M1 class fireproof fabric available in 7 standard colors: green, gray, black, light blue, light beige, orange, yellow > Set of 4 castors with brake - ø 65 mm
INTERNAL DIMENSIONS	Filing drawer W 285 mm x D 325 mm x H 255 mm	NET WEIGHT	27,50 Kg
HANGING FILES	Capacity N ° 22 hanging files of 330 mm vertically	PACKAGING	<ul style="list-style-type: none"> > volume: 0,10 m³ > recycled and recyclable cardboard > Multiple on pallets > Optimized for transport with CO2 reduction > Supplied: Assembled > No. of packages: 1
PRODUCTION	<ul style="list-style-type: none"> > Dieffebi S.p.a. > Start of production: 2013 > Country of production: Italy 	END OF USE	> Equipped with disassembly card for disposal
MAINTENANCE	<ul style="list-style-type: none"> > Clean with a soft cloth > Do not treat the surfaces with abrasive cloths 	WARRANTY	> Dieffebi guarantees that the product was made using high quality materials - See warranty document
MATERIALS	> Structure made of recycled and recyclable metal		
FINISHING	<ul style="list-style-type: none"> > Low-emission powder coating (material inert) > Free from heavy metals > Absence of sharp edges and cutting edges > Anti-glare finish > It does not contain VOCs 		
STANDARD COMPONENTS	<ul style="list-style-type: none"> > Handle in plastic material painted with the standard color anthracite gray RAL 7021 > Cylinder lock with two keys (fixed + folding), central locking and removable cylinder > Master key available on request > Guides: hidden with amortized sliding and full extension > Filing drawer: completely closed equipped with prearranged folder holders for 330 mm suspension files > Counterweight included > Screws for fixing between modules 		

DotBox

MADE IN ITALY

Mobile pedestal
W 400 x D 410 x H 470 mm

DESIGNER Hangar Design Group

WELLNESS AND ENVIRONMENT

> Green design in accordance with LEED® standards, to design and furnish environments with a high sustainability content



www.GreenTop.com

METAL TEST

- > UNI EN ISO 2409:2013
- > EN ISO 1520:2006
- > NSS UNI EN ISO 9227:2017
- > UNI 9300:2015
- > UNI EN 15187:2007
- > UNI EN ISO 6272-1:2013
- > EN 12720:2013
- > UNI EN 15185:2011
- > EN 12721:2013
- > UNI EN 15186:2012, met.B
- > UNI 9429:2015

CLASS OF

> Class 0

REACTION TO FIRE

POSITIONING

> Free standing

ASSEMBLY CONSTRAINTS

> Compositions:

on the wall center of the room on wheels

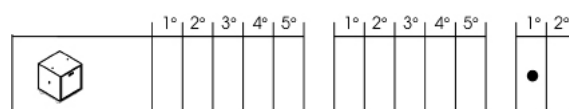

> Composition: example

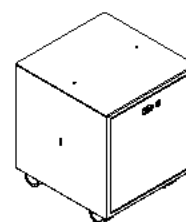

1° LIVELLO
STEP 1



ADIMEMBER



acquistinretepa.it
Il Portale degli Appalti della Pubblica Amministrazione

DotBox

MADE IN ITALY

Varnish
Vernici
Vernis
Lacke

Cabinet Body
Corpo
Caisson
Korpus

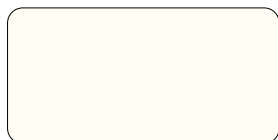

-V1
S711 (RAL 9010)
Pure white



-V2
7044 (RAL 7044)
Silk grey

Handles
Maniglie
Poignées
Griffe



-V8
6013 (RAL 6013)
Reed green



-V15
1021 (RAL 1021)
Rape yellow



-V17
5024 (RAL 5024)
Pastel blue



-V24
3005 (RAL 3005)
Wine red

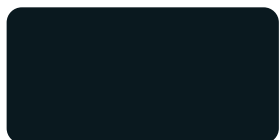

-V19
S210 (RAL 7021)
Black grey

Glass
Vetro
Verre
Glas

Top
Piano
Plateau
Tischplatte



-G1
Bianco/White/Blanc/Weiß

DotBox

MADE IN ITALY

Fabrics
Tessuti
Tissus
Textilien

Cushion
Cuscino
Coussin
Sitzkissen



- T3
8009
Jet, Fidivi

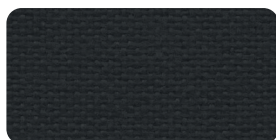

- T4
8033
Jet, Fidivi



-T7
213
Divina MD, Kvadrat

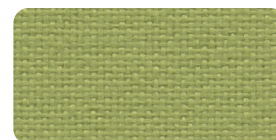

-T12
7041
Jet, Fidivi

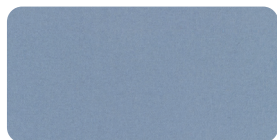

- T18
701
Hero, Kvadrat



- T24
462
Mirage, Pugi · PG



-T31
133
Mirage, Pugi · PG