



## DotBox

MADE IN ITALY

Flower container  
W 800 x D 410 x H 180 mm

V1  white RAL 9010 art.6D0500010 S711  
V2  silk grey RAL 7044 art.6D0500010 7044

DESIGNER Hangar Design Group

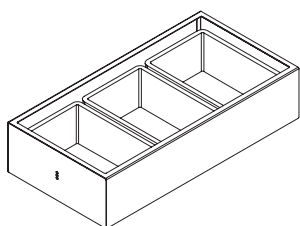

Front

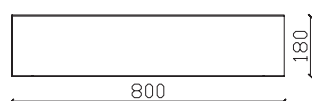

Side

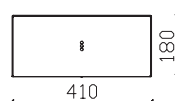

Back

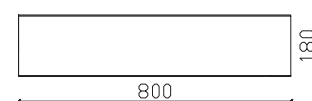

# DotBox

MADE IN ITALY

## Flower container

W 800 x D 410 x H 180 mm

### DESIGNER Hangar Design Group

<b>DESCRIPTION</b>	Modular system
<b>DIMENSIONS</b>	W 800 mm x D 410 mm x H180 mm
<b>INTERNAL DIMENSIONS</b>	W 765 mm x D 365 mm x H178 mm
<b>PRODUCTION</b>	<ul style="list-style-type: none"> <li>&gt; Dieffebi S.p.a.</li> <li>&gt; Start of production: 2013</li> <li>&gt; Country of production: Italy</li> </ul>
<b>MAINTENANCE</b>	<ul style="list-style-type: none"> <li>&gt; Clean with a soft cloth</li> <li>&gt; Do not treat the surfaces with abrasive cloths</li> </ul>
<b>MATERIALS</b>	> Structure made of recycled and recyclable metal
<b>FINISHING</b>	<ul style="list-style-type: none"> <li>&gt; Low-emission powder coating (material inert)</li> <li>&gt; Free from heavy metals</li> <li>&gt; Absence of sharp edges and cutting edges</li> <li>&gt; Anti-glare finish</li> <li>&gt; It does not contain VOCs</li> </ul>
<b>STANDARD COMPONENTS</b>	<ul style="list-style-type: none"> <li>&gt; Three plastic trays to contain plants</li> <li>&gt; Screws and double-sided tape for fixing between modules</li> </ul>

<b>COLORS</b>	<ul style="list-style-type: none"> <li>&gt; Available in 2 standard colors</li> <li>&gt; Standard semi-gloss colors</li> <li>&gt; Customizable colors available upon request and with an extra charge</li> </ul> <p><a href="http://www.dieffebi.com/docs/299/2832/DFB_Colour-Chart-2020.pdf">www.dieffebi.com/docs/299/2832/DFB_Colour-Chart-2020.pdf</a></p> <p><a href="http://www.dieffebi.com/it/news">www.dieffebi.com/it/news</a></p>
---------------	--

<b>NET WEIGHT</b>	7,00 Kg
-------------------	---------

<b>PACKAGING</b>	<ul style="list-style-type: none"> <li>&gt; volume: 0,08 m<sup>3</sup></li> <li>&gt; recycled and recyclable cardboard</li> <li>&gt; Multiple on pallets</li> <li>&gt; Optimized for transport with CO2 reduction</li> <li>&gt; Supplied: assembled</li> <li>&gt; No. of packages: 1</li> </ul>
------------------	---

<b>END OF USE</b>	> Equipped with disassembly card for disposal
-------------------	---

<b>WARRANTY</b>	> Dieffebi guarantees that the product was made using high quality materials - <a href="#">See warranty document</a>
-----------------	--

# DotBox

MADE IN ITALY

Flower container  
W 800 x D 410 x H 180 mm

DESIGNER Hangar Design Group

**WELLNESS AND ENVIRONMENT** > Green design in accordance with LEED® standards, to design and furnish environments with a high sustainability content



**ASSEMBLY CONSTRAINTS** > Compositions:  
on the wall      center of the room      on wheels

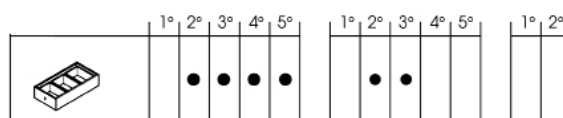

**METAL TEST**

- > UNI EN ISO 2409:2013      > EN ISO 1520:2006
- > NSS UNI EN ISO 9227:2017      > UNI 9300:2015
- > UNI EN 15187:2007      > UNI EN ISO 6272-1:2013
- > EN 12720:2013      > UNI EN 15185:2011
- > EN 12721:2013      > UNI EN 15186:2012, met.B
- > UNI 9429:2015

> Composition: example

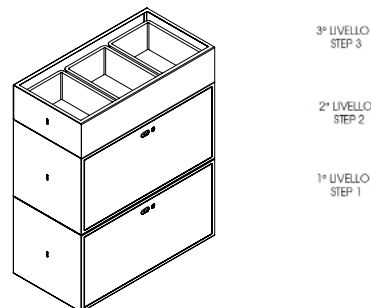

**CLASS OF REACTION TO FIRE** > Class 0

**POSITIONING** > Both on the wall and in the center of the room



## DotBox

MADE IN ITALY

---

Varnish  
Vernici  
Vernis  
Lacke

---

Cabinet Body  
Corpo  
Caisson  
Korpus



**-V1**  
S711 (RAL 9010)  
Pure white





**-V2**  
7044 (RAL 7044)  
Silk grey

## DotBox

MADE IN ITALY

Unit with  
air device Itair  
W 800 x D 410 x H 400 mm

V1  white RAL 9010 art.6D1100040 S711  
V2  silk grey RAL 7044 art.6D1100040 7044

DESIGNER Hangar Design Group

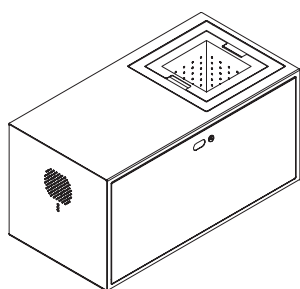

Front

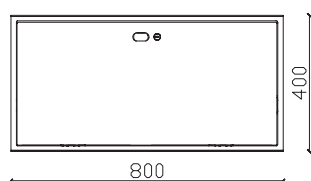

Side

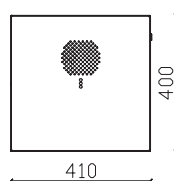

Back

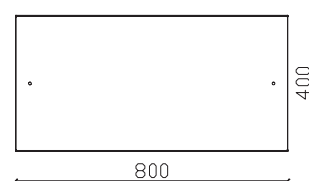

## DotBox

MADE IN ITALY

Unit with  
air device Itair  
W 800 x D 410 x H 400 mm

DESIGNER Hangar Design Group

<b>DESCRIPTION</b>	Modular system	> Master key available on request > Screws for fixing between modules
<b>DIMENSIONS</b>	W 800 mm x D 410 mm x H 400 mm	
<b>INTERNAL DIMENSIONS</b>	Basket for plants W 184 mm x D 184 mm x H 215 mm	
<b>PRODUCTION</b>	> Dieffebi S.p.a. > Start of production: 2013 > Country of production: Italy	
<b>MAINTENANCE</b>	> Clean with a soft cloth > Do not treat the surfaces with abrasive cloths	
<b>MATERIALS</b>	> Structure made of recycled and recyclable metal	
<b>FINISHING</b>	> Low-emission powder coating (material inert) > Free from heavy metals > Absence of sharp edges and cutting edges > Anti-glare finish > It does not contain VOCs	
<b>STANDARD COMPONENTS</b>	> Internal vase for plant housing in metal with self-watering system > External metal vase containing tech-unit, dimensions 290 x 260 x H230 / frame 325 x 325 > Power supply 100-240 Vac - max consumption 6W > Sensors for detecting temperature, humidity and air quality for the detection of volatile organic compounds (VOC) > Wifi b / g / n connections > IOS - Android app > Handle in plastic material painted with the standard color anthracite gray RAL 7021 > Flap opening door with articulated arms and support and closure hinges on the casing with lock BURG F.W. Lüling KG > Cylinder lock: with two keys (fixed + folding), central locking and removable cylinder	
<b>COLORS</b>	> Available in 2 standard colors > Standard semi-gloss colors > Customizable colors available upon request and with an extra charge <a href="http://www.dieffebi.com/docs/299/2832/DFB_Colour-Chart-2020.pdf">www.dieffebi.com/docs/299/2832/DFB_Colour-Chart-2020.pdf</a> <a href="http://www.dieffebi.com/it/news">www.dieffebi.com/it/news</a>	
<b>ACCESSORIES</b>	> Painted plastic handle available in 5 colors > External fabric panel available in 7 standard colors: green, gray, black, light blue, light beige, orange, yellow > Panel fixing: with adhesive > Chromed leveling feet h 110 mm > Set of 4 castors with brake - ø 65 mm > Set of 4 castors without brake - ø 65 mm	
<b>NET WEIGHT</b>	29,00 Kg	
<b>PACKAGING</b>	> volume: 0,19 m <sup>3</sup> > recycled and recyclable cardboard > Multiple on pallets > Optimized for transport with CO2 reduction > Supplied: assembled > No. of packages: 1	
<b>END OF USE</b>	> Equipped with disassembly card for disposal	
<b>WARRANTY</b>	> Dieffebi guarantees that the product was made using high quality materials - <a href="#">See warranty document</a>	

# DotBox

MADE IN ITALY

Unit with  
air device Itair  
W 800 x D 410 x H 400 mm

DESIGNER Hangar Design Group

**WELLNESS AND ENVIRONMENT** > Green design in accordance with LEED® standards, to design and furnish environments with a high sustainability content



**ASSEMBLY CONSTRAINTS** > Compositions:  
on the wall      center of the room      on wheels

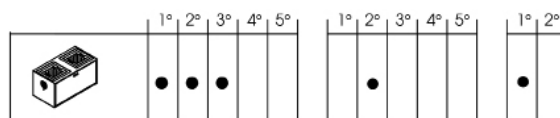

**METAL TEST**

- > UNI EN ISO 2409:2013      > EN ISO 1520:2006
- > NSS UNI EN ISO 9227:2017      > UNI 9300:2015
- > UNI EN 15187:2007      > UNI EN ISO 6272-1:2013
- > EN 12720:2013      > UNI EN 15185:2011
- > EN 12721:2013      > UNI EN 15186:2012, met.B
- > UNI 9429:2015

> Composition: example of wall composition

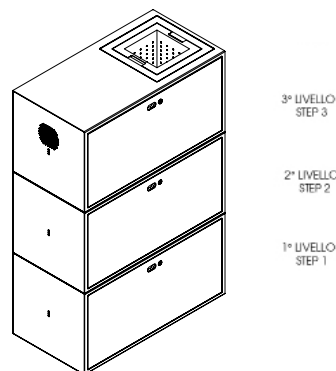

**CLASS OF REACTION TO FIRE** > Class 0

**POSITIONING** > Both on the wall and in the center of the room

**MODULARITY** > Horizontal



ADIMEMBER



## DotBox

MADE IN ITALY

Varnish  
Vernici  
Vernis  
Lacke

Cabinet Body  
Corpo  
Caisson  
Korpus



-V1  
S711 (RAL 9010)  
Pure white



-V2  
7044 (RAL 7044)  
Silk grey

Handles  
Maniglie  
Poignées  
Griffe



-V8  
6013 (RAL 6013)  
Reed green



-V15  
1021 (RAL 1021)  
Rape yellow



-V17  
5024 (RAL 5024)  
Pastel blue



-V24  
3005 (RAL 3005)  
Wine red

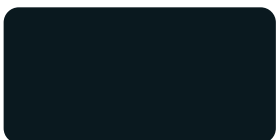

-V19  
S210 (RAL 7021)  
Black grey

Fabrics  
Tessuti  
Tissus  
Textilien

External panel  
Pannello esterno  
Panneau extérieur  
Außenpaneel



- T3  
8009  
Jet, Fidivi

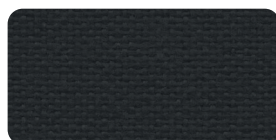

- T4  
8033  
Jet, Fidivi



-T7  
213  
Divina MD, Kvadrat

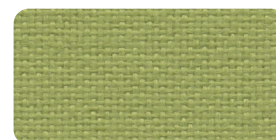

-T12  
7041  
Jet, Fidivi

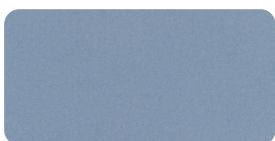

- T18  
701  
Hero, Kvadrat

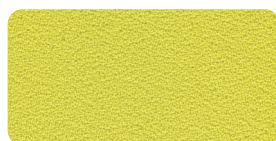

- T24  
462  
Mirage, Pugi · PG



-T31  
153  
Mirage, Pugi · PG



## DotBox

MADE IN ITALY

Unit with air  
and music devices Itair  
W 800 x D 410 x H 400 mm

V1  white RAL 9010 art.6D1100030 S711  
V2  silk grey RAL 7044 art.6D1100030 7044

DESIGNER Hangar Design Group

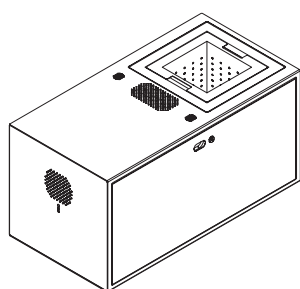

Front

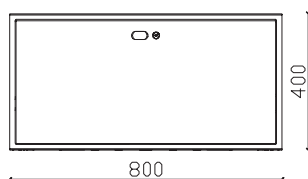

Side

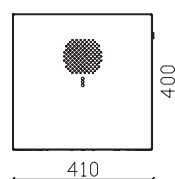

Back

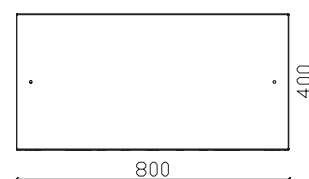

## DotBox

MADE IN ITALY

Unit with air  
and music devices Itair  
W 800 x D 410 x H 400 mm

DESIGNER Hangar Design Group

<b>DESCRIPTION</b>	Modular system	<ul style="list-style-type: none"> <li>&gt; Single container volume 1.1 L, total volume plant 2.2 L.</li> </ul>
<b>DIMENSIONS</b>	W 800 mm x D 410 mm x H 400 mm	<ul style="list-style-type: none"> <li>&gt; Handle in plastic material painted with the standard color anthracite gray RAL 7021</li> <li>&gt; Flap opening door with articulated arms and support and closure hinges on the casing with lock BURG F.W. Lüling KG</li> <li>&gt; Cylinder lock: with two keys (fixed + folding), central locking with removable cylinder</li> <li>&gt; Master key available on request</li> <li>&gt; Screws for fixing between modules</li> </ul>
<b>INTERNAL DIMENSIONS</b>	Basket for plants W 184 mm x D 184 mm x H 215 mm	
<b>PRODUCTION</b>	<ul style="list-style-type: none"> <li>&gt; Dieffebi S.p.a.</li> <li>&gt; Start of production: 2013</li> <li>&gt; Country of production: Italy</li> </ul>	
<b>MAINTENANCE</b>	<ul style="list-style-type: none"> <li>&gt; Clean with a soft cloth</li> <li>&gt; Do not treat the surfaces with abrasive cloths</li> </ul>	<b>COLORS</b>
<b>MATERIALS</b>	<ul style="list-style-type: none"> <li>&gt; Structure made of recycled and recyclable metal</li> </ul>	<ul style="list-style-type: none"> <li>&gt; Available in 2 standard colors</li> <li>&gt; Standard semi-gloss colors</li> <li>&gt; Customizable colors available upon request and with an extra charge</li> <li><a href="http://www.dieffebi.com/docs/299/2832/DFB_Colour-Chart-2020.pdf">www.dieffebi.com/docs/299/2832/DFB_Colour-Chart-2020.pdf</a>.</li> <li><a href="http://www.dieffebi.com/it/news">www.dieffebi.com/it/news</a></li> </ul>
<b>FINISHING</b>	<ul style="list-style-type: none"> <li>&gt; Low-emission powder coating (material inert)</li> <li>&gt; Free from heavy metals</li> <li>&gt; Absence of sharp edges and cutting edges</li> <li>&gt; Anti-glare finish</li> <li>&gt; It does not contain VOCs</li> </ul>	<b>ACCESSORIES</b>
<b>STANDARD COMPONENTS</b>	<ul style="list-style-type: none"> <li>&gt; Internal vase for plant housing in metal with self-watering system</li> <li>&gt; External metal vase containing tech-unit, dimensions 290x260xH230 / frame 325x325</li> <li>&gt; Power supply 100-240 Vac - max consumption 6W</li> <li>&gt; Sensors for detecting temperature, humidity and air quality for the detection of volatile organic compounds (VOC)</li> <li>&gt; Wifi b / g / n connections</li> <li>&gt; IOS - Android app</li> <li>&gt; Music No. 4 full-range speakers</li> <li>&gt; No. 1 control board</li> <li>&gt; Maximum power 12 Wrms</li> <li>&gt; Bluetooth 3.0 connection with A2DP profile</li> <li>&gt; Class D amplifier</li> <li>&gt; Frequency response 200-20.000 Hz</li> <li>&gt; Electrical insulation class CLASS II</li> <li>&gt; Power supply 100-240 Vac 50/60 Hz 15W max</li> </ul>	<ul style="list-style-type: none"> <li>&gt; Painted plastic handle available in 5 colors</li> <li>&gt; External fabric panel available in 7 standard colors: green, gray, black, light blue, light beige, orange, yellow</li> <li>&gt; Panel fixing: with adhesive</li> <li>&gt; Chromed leveling feet h 110 mm</li> <li>&gt; Set of 4 castors with brake - ø 65 mm</li> <li>&gt; Set of 4 castors without brake - ø 65 mm</li> </ul>
		<b>NET WEIGHT</b>
		30,50 Kg
		<b>PACKAGING</b>
		<ul style="list-style-type: none"> <li>&gt; volume: 0,19 m<sup>3</sup></li> <li>&gt; recycled and recyclable cardboard</li> <li>&gt; Multiple on pallets</li> <li>&gt; Optimized for transport with CO2 reduction</li> <li>&gt; Supplied: assembled</li> <li>&gt; No. of packages: 1</li> </ul>
		<b>END OF USE</b>
		<ul style="list-style-type: none"> <li>&gt; Equipped with disassembly card for disposal</li> </ul>
		<b>WARRANTY</b>
		<ul style="list-style-type: none"> <li>&gt; Dieffebi guarantees that the product was made using high quality materials - <a href="#">See warranty document</a></li> </ul>

## DotBox

MADE IN ITALY

Unit with air  
and music devices Itair  
W 800 x D 410 x H 400 mm

DESIGNER Hangar Design Group

## WELLNESS AND ENVIRONMENT

> Green design in accordance with LEED® standards, to design and furnish environments with a high sustainability content



www.GreenTop.com

## METAL TEST

> UNI EN ISO 2409:2013 > EN ISO 1520:2006  
> NSS UNI EN ISO 9227:2017 > UNI 9300:2015  
> UNI EN 15187:2007 > UNI EN ISO 6272-1:2013  
> EN 12720:2013 > UNI EN 15185:2011  
> EN 12721:2013 > UNI EN 15186:2012, met.B  
> UNI 9429:2015

## CLASS OF REACTION TO FIRE

> Class 0

## POSITIONING

> Both on the wall and in the center of the room

## MODULARITY

> Horizontal

## ASSEMBLY CONSTRAINTS

> Compositions:

on the wall center of the room on wheels

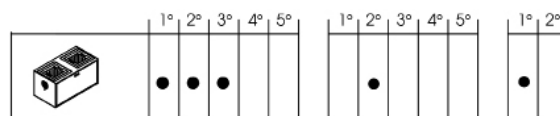

> Composition: example

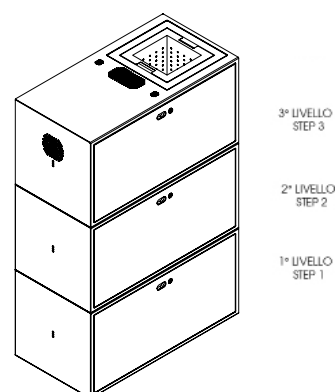

dieffebi



MADE IN EUROPE



ASSUFFICIO ASSOCIAZIONE FIDELIENSDARRECO

ADIMEMBER



consip  
acquistinretepa.it  
Il Portale degli Appalti della Pubblica Amministrazione

## DotBox

MADE IN ITALY

Varnish  
Vernici  
Vernis  
Lacke

Cabinet Body  
Corpo  
Caisson  
Korpus

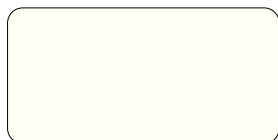

-V1  
S711 (RAL 9010)  
Pure white



-V2  
7044 (RAL 7044)  
Silk grey

Handles  
Maniglie  
Poignées  
Griffe



-V8  
6013 (RAL 6013)  
Reed green



-V15  
1021 (RAL 1021)  
Rape yellow



-V17  
5024 (RAL 5024)  
Pastel blue



-V24  
3005 (RAL 3005)  
Wine red

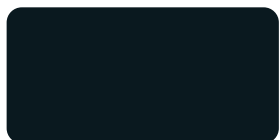

-V19  
S210 (RAL 7021)  
Black grey

Fabrics  
Tessuti  
Tissus  
Textilien

External panel  
Pannello esterno  
Panneau extérieur  
Außenpaneel



- T3  
8009  
Jet, Fidivi

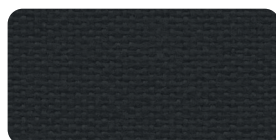

- T4  
8033  
Jet, Fidivi



-T7  
213  
Divina MD, Kvadrat

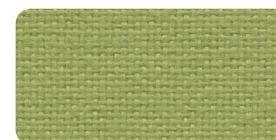

-T12  
7041  
Jet, Fidivi

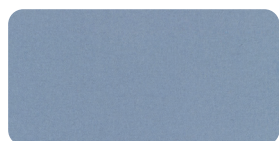

- T18  
701  
Hero, Kvadrat

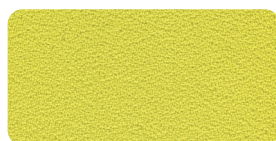

- T24  
462  
Mirage, Pugi · PG





-T31  
153  
Mirage, Pugi · PG

## DotBox

MADE IN ITALY

Unit with  
two air devices Itair  
W 800 x D 410 x H 400 mm

V1  white RAL 9010 art.6D1100020 S711  
V2  silk grey RAL 7044 art.6D1100020 7044

DESIGNER Hangar Design Group

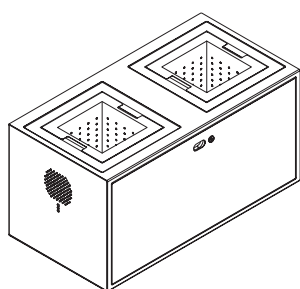

Front

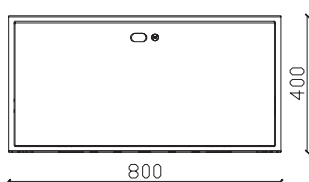

Side

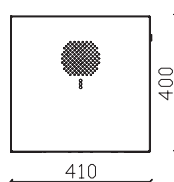

Back

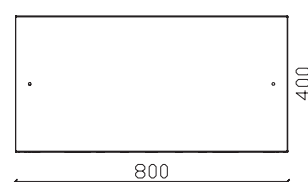

## DotBox

MADE IN ITALY

Unit with  
two air devices Itair  
W 800 x D 410 x H 400 mm

DESIGNER Hangar Design Group

<b>DESCRIPTION</b>	Modular system	<ul style="list-style-type: none"> <li>&gt; Master key available on request</li> <li>&gt; Screws for fixing between modules</li> </ul>
<b>DIMENSIONS</b>	W 800 mm x D 410 mm x H 400 mm	
<b>INTERNAL DIMENSIONS</b>	Baskets - N° 2 - for plants W 184 mm x D 184 mm x H 215 mm	<b>COLORS</b> <ul style="list-style-type: none"> <li>&gt; Available in 2 standard colors</li> <li>&gt; Standard semi-gloss colors</li> <li>&gt; Customizable colors available upon request and with an extra charge</li> <li><a href="http://www.dieffebi.com/docs/299/2832/DFB_Colour-Chart-2020.pdf">www.dieffebi.com/docs/299/2832/DFB_Colour-Chart-2020.pdf</a></li> <li><a href="http://www.dieffebi.com/it/news">www.dieffebi.com/it/news</a></li> </ul>
<b>PRODUCTION</b>	<ul style="list-style-type: none"> <li>&gt; Dieffebi S.p.a.</li> <li>&gt; Start of production: 2013</li> <li>&gt; Country of production: Italy</li> </ul>	
<b>MAINTENANCE</b>	<ul style="list-style-type: none"> <li>&gt; Clean with a soft cloth</li> <li>&gt; Do not treat the surfaces with abrasive cloths</li> </ul>	
<b>MATERIALS</b>	> Structure made of recycled and recyclable metal	<b>ACCESSORIES</b> <ul style="list-style-type: none"> <li>&gt; Painted plastic handle available in 5 colors</li> <li>&gt; External fabric panel available in 7 standard colors: green, gray, black, light blue, light beige, orange, yellow</li> <li>&gt; Panel fixing: with adhesive</li> <li>&gt; Chromed leveling feet h 110 mm</li> <li>&gt; Set of 4 castors with brake - ø 65 mm</li> <li>&gt; Set of 4 castors without brake - ø 65 mm</li> </ul>
<b>FINISHING</b>	<ul style="list-style-type: none"> <li>&gt; Low-emission powder coating (material inert)</li> <li>&gt; Free from heavy metals</li> <li>&gt; Absence of sharp edges and cutting edges</li> <li>&gt; Anti-glare finish</li> <li>&gt; It does not contain VOCs</li> </ul>	
<b>STANDARD COMPONENTS</b>	<ul style="list-style-type: none"> <li>&gt; Internal vase for plant housing in metal with self-watering system</li> <li>&gt; External metal vase containing tech-unit, dimensions 290x260xH230 / frame 325x325</li> <li>&gt; Power supply 100-240 Vac - max consumption 6W</li> <li>&gt; Sensors for detecting temperature, humidity and air quality for the detection of volatile organic compounds (VOC)</li> <li>&gt; Wifi b / g / n connections</li> <li>&gt; IOS - Android app</li> <li>&gt; Handle in plastic material painted with the standard color anthracite gray RAL 7021</li> <li>&gt; Flap opening door with articulated arms and support and closure hinges on the casing with lock BURG F.W. Lüling KG</li> <li>&gt; Cylinder lock: with two keys (fixed + folding), central locking and removable cylinder</li> </ul>	<b>NET WEIGHT</b> 31,00 Kg  <b>PACKAGING</b> <ul style="list-style-type: none"> <li>&gt; volume: 0,19 m<sup>3</sup></li> <li>&gt; recycled and recyclable cardboard</li> <li>&gt; Multiple on pallets</li> <li>&gt; Optimized for transport with CO2 reduction</li> <li>&gt; Supplied: assembled</li> <li>&gt; No. of packages: 1</li> </ul>
		<b>END OF USE</b> <ul style="list-style-type: none"> <li>&gt; Equipped with disassembly card for disposal</li> </ul>
		<b>WARRANTY</b> <ul style="list-style-type: none"> <li>&gt; Dieffebi guarantees that the product was made using high quality materials - <a href="#">See warranty document</a></li> </ul>

# DotBox

MADE IN ITALY

Unit with  
two air devices Itair  
W 800 x D 410 x H 400 mm

DESIGNER Hangar Design Group

**WELLNESS AND ENVIRONMENT** > Green design in accordance with LEED® standards, to design and furnish environments with a high sustainability content



**ASSEMBLY CONSTRAINTS** > Compositions:  
on the wall      center of the room      on wheels

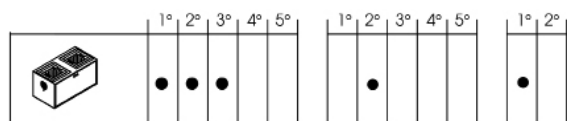

**METAL TEST**

- > UNI EN ISO 2409:2013      > EN ISO 1520:2006
- > NSS UNI EN ISO 9227:2017      > UNI 9300:2015
- > UNI EN 15187:2007      > UNI EN ISO 6272-1:2013
- > EN 12720:2013      > UNI EN 15185:2011
- > EN 12721:2013      > UNI EN 15186:2012, met.B
- > UNI 9429:2015

> Composition: example of wall composition

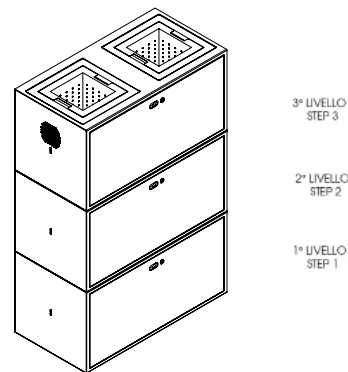

**CLASS OF REACTION TO FIRE** > Class 0

**POSITIONING** > Both on the wall and in the center of the room

**MODULARITY** > Horizontal



ADIMEMBER



## DotBox

MADE IN ITALY

Varnish  
Vernici  
Vernis  
Lacke

Cabinet Body  
Corpo  
Caisson  
Korpus

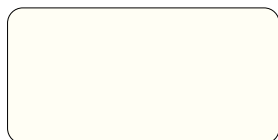

-V1  
S711 (RAL 9010)  
Pure white



-V2  
7044 (RAL 7044)  
Silk grey

Handles  
Maniglie  
Poignées  
Griffe



-V8  
6013 (RAL 6013)  
Reed green



-V15  
1021 (RAL 1021)  
Rape yellow



-V17  
5024 (RAL 5024)  
Pastel blue



-V24  
3005 (RAL 3005)  
Wine red

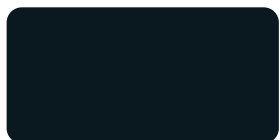

-V19  
S210 (RAL 7021)  
Black grey

Fabrics  
Tessuti  
Tissus  
Textilien

External panel  
Pannello esterno  
Panneau extérieur  
Außenpaneel



- T3  
8009  
Jet, Fidivi

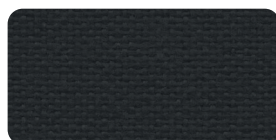

- T4  
8033  
Jet, Fidivi



-T7  
213  
Divina MD, Kvadrat

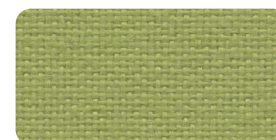

-T12  
7041  
Jet, Fidivi

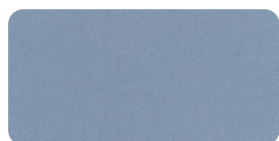

- T18  
701  
Hero, Kvadrat

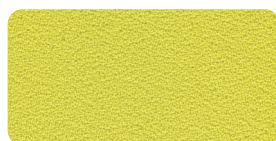

- T24  
462  
Mirage, Pugi · PG





-T31  
153  
Mirage, Pugi · PG



## DotBox

MADE IN ITALY

Unit with two air  
and music devices Itair  
W 800 x D 410 x H 400 mm

V1  white RAL 9010 art.6D1100010 S711  
V2  silk grey RAL 7044 art.6D1100010 7044

DESIGNER Hangar Design Group

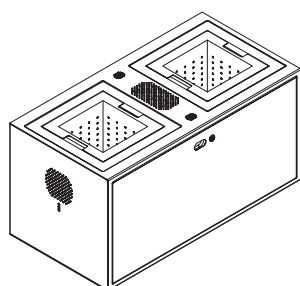

Front

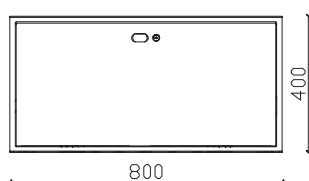

Side

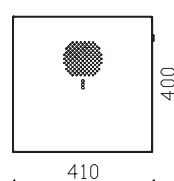

Back



## DotBox

MADE IN ITALY

Unit with two air  
and music devices Itair  
W 800 x D 410 x H 400 mm

DESIGNER Hangar Design Group

<b>DESCRIPTION</b>	Modular system	> Single container volume 1.1 L, total volume plant 2.2 L.
<b>DIMENSIONS</b>	W 800 mm x D 410 mm x H 400 mm	> Handle in plastic material painted with the standard color anthracite gray RAL 7021
<b>INTERNAL DIMENSIONS</b>	Baskets - N° 2 - for plants W 184 mm x D 184 mm x H 215 mm	> Flap opening door with articulated arms and support and closure hinges on the casing with lock BURG F.W. Lüling KG
<b>PRODUCTION</b>	> Dieffebi S.p.a. > Start of production: 2013 > Country of production: Italy	> Cylinder lock: with two keys (fixed + folding), central locking with removable cylinder > Master key available on request > Screws for fixing between modules
<b>MAINTENANCE</b>	> Clean with a soft cloth > Do not treat the surfaces with abrasive cloths	<b>COLORS</b>
<b>MATERIALS</b>	> Structure made of recycled and recyclable metal	> Available in 2 standard colors > Standard semi-gloss colors > Customizable colors available upon request and with an extra charge <a href="http://www.dieffebi.com/docs/299/2832/DFB_Colour-Chart-2020.pdf">www.dieffebi.com/docs/299/2832/DFB_Colour-Chart-2020.pdf</a> <a href="http://www.dieffebi.com/it/news">www.dieffebi.com/it/news</a>
<b>FINISHING</b>	> Low-emission powder coating (material inert) > Free from heavy metals > Absence of sharp edges and cutting edges > Anti-glare finish > It does not contain VOCs	<b>ACCESSORIES</b>
<b>STANDARD COMPONENTS</b>	> Internal vase for plant housing in metal with self-watering system > External metal vase containing tech-unit, dimensions 290x260xH230 / frame 325x325 > Power supply 100-240 Vac - max consumption 6W > Sensors for detecting temperature, humidity and air quality for the detection of volatile organic compounds (VOC) > Wifi b / g / n connections > IOS - Android app > Music No. 4 full-range speakers > No. 1 control board > Maximum power 12 Wrms > Bluetooth 3.0 connection with A2DP profile > Class D amplifier > Frequency response 200-20.000 Hz > Electrical insulation class CLASS II > Power supply 100-240 Vac 50/60 Hz 15W max	> Painted plastic handle available in 5 colors > External fabric panel available in 7 standard colors: green, gray, black, light blue, light beige, orange, yellow > Panel fixing: with adhesive > Chromed leveling feet h 110 mm > Set of 4 castors with brake - ø 65 mm > Set of 4 castors without brake - ø 65 mm
		<b>NET WEIGHT</b> 32,50 Kg
		<b>PACKAGING</b>
		> volume: 0,19 m <sup>3</sup> > recycled and recyclable cardboard > Multiple on pallets > Optimized for transport with CO2 reduction > Supplied: assembled > No. of packages: 1
		<b>END OF USE</b>
		> Equipped with disassembly card for disposal
		<b>WARRANTY</b>
		> Dieffebi guarantees that the product was made using high quality materials - <a href="#">See warranty document</a>

# DotBox

MADE IN ITALY

Unit with two air and music devices Itair  
W 800 x D 410 x H 400 mm

DESIGNER Hangar Design Group

**WELLNESS AND ENVIRONMENT** > Green design in accordance with LEED® standards, to design and furnish environments with a high sustainability content



**ASSEMBLY CONSTRAINTS** > Compositions:  
on the wall      center of the room      on wheels

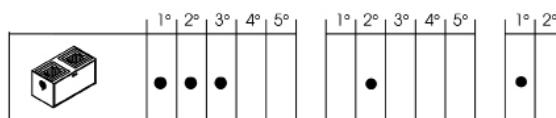

**METAL TEST**

- > UNI EN ISO 2409:2013      > EN ISO 1520:2006
- > NSS UNI EN ISO 9227:2017      > UNI 9300:2015
- > UNI EN 15187:2007      > UNI EN ISO 6272-1:2013
- > EN 12720:2013      > UNI EN 15185:2011
- > EN 12721:2013      > UNI EN 15186:2012, met.B
- > UNI 9429:2015

> Composition: example

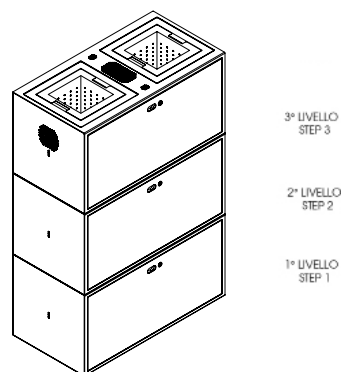

**CLASS OF REACTION TO FIRE** > Class 0

**POSITIONING** > Both on the wall and in the center of the room

**MODULARITY** > Horizontal



ADIMEMBER



## DotBox

MADE IN ITALY

Varnish  
Vernici  
Vernis  
Lacke

Cabinet Body  
Corpo  
Caisson  
Korpus

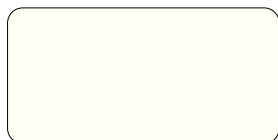

-V1  
S711 (RAL 9010)  
Pure white



-V2  
7044 (RAL 7044)  
Silk grey

Handles  
Maniglie  
Poignées  
Griffe



-V8  
6013 (RAL 6013)  
Reed green



-V15  
1021 (RAL 1021)  
Rape yellow



-V17  
5024 (RAL 5024)  
Pastel blue



-V24  
3005 (RAL 3005)  
Wine red

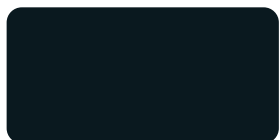

-V19  
S210 (RAL 7021)  
Black grey

Fabrics  
Tessuti  
Tissus  
Textilien

External panel  
Pannello esterno  
Panneau extérieur  
Außenpaneel



- T3  
8009  
Jet, Fidivi

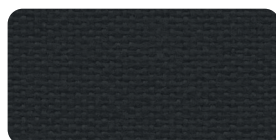

- T4  
8033  
Jet, Fidivi



-T7  
213  
Divina MD, Kvadrat



-T12  
7041  
Jet, Fidivi

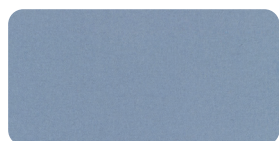

- T18  
701  
Hero, Kvadrat

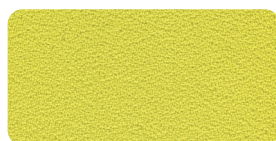

- T24  
462  
Mirage, Pugi · PG



-T31  
153  
Mirage, Pugi · PG