

T-Share

MADE IN ITALY

Tavolo T-Share Meeting/Operativo

L 2200 mm x P 1300 mm
x H 740 mm

Piano: Fenix

FX1 ○ bianco Malè
FX2 ● grigio Efeso
FX3 ● grigio London

Struttura: metallo

V1 ○ bianco RAL 9010
V16 ● manganese S051
V16 ● manganese S051

Canalina: metallo

V26 ● nero RAL 9005
V25 ● giallo RAL 1006
V25 ● giallo RAL 1006art.3H2201300 XBBN
art.3H2201300 XGAF
art.3H2201300 XGAC

Piano: MDF Perfect Sense

D1 ○ bianco
D2 ● grigio caldo
D3 ● nero opaco

Struttura: metallo

V1 ○ bianco RAL 9010
V16 ● manganese S051
V26 ● nero RAL 9005

Canalina: metallo

V1 ○ bianco RAL 9010
V25 ● giallo RAL 1006
V26 ● nero RAL 9005art.3H2201300 XM2C
art.3H2201300 XM3A
art.3H2201300 XM3N

Piano: melaminico

M1 ○ bianco
M2 ● grigio chiaro
MW1 ● acero

Struttura: metallo

V1 ○ bianco RAL 9010
V16 ● manganese S051
V26 ● nero RAL 9005

Canalina: metallo

V1 ○ bianco RAL 9010
V25 ● giallo RAL 1006
V26 ● nero RAL 9005art.3H2201300 XM3B
art.3H2201300 XM1G
art.3H2201300 XM1N

DESIGN 967 ARCH

Fianco

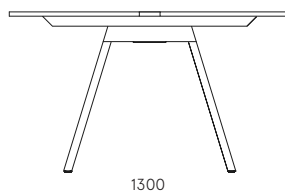

Fronte

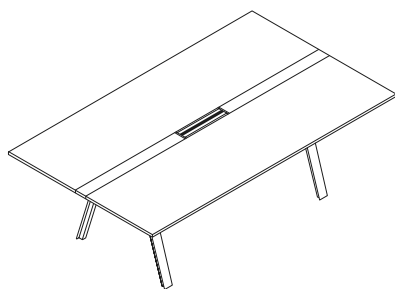
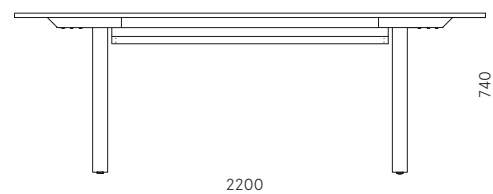

Copyright © dieffebi

T-Share

MADE IN ITALY

Tavolo T-Share Meeting/Operativo

L 2200 mm x P 1300 mm x H 740 mm

DESIGN 967 ARCH

DESCRIZIONE	Tavolo T-Share Meeting/Operativo	COLORI	<p>COLORI Struttura</p> <ul style="list-style-type: none"> > Disponibile in 2 colori standard V1 Bianco (RAL 9010) V16 Manganese <p>COLORI Canale</p> <ul style="list-style-type: none"> > Disponibile in 3 colori standard V25 Giallo (RAL 1006) V26 Nero (RAL 9005) V1 Bianco (RAL 9010) <p>COLORI PIANO</p> <ul style="list-style-type: none"> > Fenix disponibile in 3 colori standard FX1 Bianco (Malè); FX2 Grigio (Efeso); FX3 Grigio (London) > MDF Perfect Sense disponibile in 3 colori standard: D1 Bianco opaco; D2 Grigio caldo; D3 Nero opaco > Melaminico disponibile in 3 colori standard: M1 Bianco; M2 Grigio chiaro; MW1 Acero > Colori standard semilucidi > Colori personalizzabili su richiesta previa disponibilità e con sovrapprezzo: www.dieffebi.com/docs/299/2832/DFB_Colour-Chart-2020.pdf
DIMENSIONI ESTERNE	L 2200 mm x P 1300 mm x H 740 mm		
PRODUZIONE	<ul style="list-style-type: none"> > Dieffebi S.p.a. > Inizio produzione: anno 2019 > Luogo di produzione: Italia 		
MATERIALI	<ul style="list-style-type: none"> > struttura in metallo riciclato e riciclabile > piano in Fenix: alta resistenza al graffio e al calore, anti impronta, morbidezza al tatto, bassa riflessione della luce, riparabilità termica dei micrograffi, alta attività di abbattimento della carica batterica > Piano in MDF PerfectSense: in Premium Matt si distingue dalle altre superfici per mobili per le sue caratteristiche visive e tattili. La speciale proprietà anti-impronta riduce la formazione di impronte sulla superficie e rende la pulizia molto più semplice. Il design di tendenza, caldo e vellutato al tatto, invita a toccare la superficie > Melaminico: pannello ecologico in truciolare ricavato da legno di riciclo. Le superfici in nobilitato sono resistenti ed igieniche e non richiedono alcuna manutenzione particolare 		
FINITURA STRUTTURA	<ul style="list-style-type: none"> > Verniciatura a polveri basso emissive (materiale inerte) > Esenti da metalli pesanti > Assenza di spigoli vivi e bordi taglienti > Finitura anti riflesso > Non contiene VOC 	ACCESSORI	<ul style="list-style-type: none"> > Pannello divisorio frontale in tessuto > Pannello divisorio laterale in tessuto
COMPONENTI STANDARD	<ul style="list-style-type: none"> > Top Access (1) in alluminio verniciato con doppio sportello e setole ritenuta cavi > Canala raccogli cavi verniciata in tinta > Cover gamba per copertura passaggio cavo di alimentazione > Piedini regolabili H 10mm > Viti per assemblaggio 	PESO NETTO	94,00 Kg
		MANUTENZIONE	<ul style="list-style-type: none"> > Pulire con panno morbido > Non trattare le superfici con panni abrasivi
		IMBALLO	<ul style="list-style-type: none"> > volume: 0,77 m3 > imballo in scatola di cartone > Fornito smontato > N°colli: 9
		END OF USE	> Corredato di scheda di disassemblaggio per smaltimento
		GARANZIA	> Dieffebi garantisce che il prodotto è stato realizzato usando materiali di alta qualità - Vedi documento di garanzia.

T-Share

MADE IN ITALY

Tavolo T-Share Meeting/Operativo

L 2200 mm x P 1300 mm x H 740 mm

DESIGN 967ARCH

BENESSERE E AMBIENTE > Design "green" in accordo con gli standard LEED®, per progettare ed arredare ambienti ad alto contenuto di sostenibilità.



www.GreenTop.com



TEST FINITURA UNI EN ISO 2409:2013
STRUTTURA NSS UNI EN ISO 9227:2017
METALLO UNI EN 15187:2007EN ISO 1520:2006
 UNI EN ISO 6272-1:2013
 UNI EN 15185:2011
 UNI EN 15186:2012, met.B
 UNI 9300:2015
 EN 12720:2013
 EN 12721:2013
 UNI 9429:2015

CLASSE DI REAZIONE AL FUOCO > Struttura: Classe 0
 > Piano: Classe s1,d0



dieffebi



MADE IN EUROPE



ASSUFFICIO
 ASSOCIAZIONE FIDELIENEGARRECO

ADIMEMBER



consip
 acqustinretepa.it
Il Fornitore degli Appalti Pubblici per l'edilizia

Dieffebi SpA

via Palù 36
 San Vendemiano,
 31020 Treviso - Italia

T +39 0438 4715
 F +39 0438 471600
 exportsales@dieffebi.com
 vendite@dieffebi.com
 www.dieffebi.com

T-Share

Vernici
Varnish
Vernis
Lacke

Struttura
Frame
Piètement
Gestell



-V1
S711 (RAL 9010)
Pure white



-V16
S051
Manganese



-V26
S885 (RAL 9005)
Black opaco

Canalina
Cable duct
Goulotte pour
câblage
Kabelwanne



-V4
S708 (RAL 9010)
Pure white textured finish



-V25
S107 (RAL 1006)
Yellow



-V26
S885 (RAL 9005)
Black opaco

Fenix

Piano
Top
Plateau
Tischplatte



-FX1
Bianco/White /Blanc/Weiß – Malè



-FX2
Grigio/Grey/Gris/Grau – Efeso



-FX3
Grigio/Grey/Gris/Grau – London

MDF Perfect Sense

Piano
Top
Plateau
Tischplatte



-D1
Bianco opaco/Matt White
/Blanc mat/Matt weiß



-D2
Grigio caldo/Warm grey
/Gris chaud/Warmes Grau



-D3
Nero opaco/Matt black
/Noir mat/Mattschwarz

T-Share

Melaminico
Melamine
Mélaminé
Melamin

Piano
Top
Plateau
Tischplatte

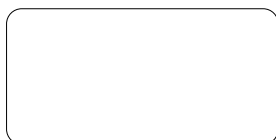

-M1
Bianco/White/Blanc/Weiß



-M2
Grigio chiaro/Light grey
/Gris clair/Hellgrau



-MW1
Acero/Maple/Érable/Ahorn

Tessuti
Fabrics
Tissus
Textilien

Pannello acustico
completo
di supporto magnetico
Fabric acoustic panel
complete
with magnetic support
Panneau acoustique
avec support magnétique
Stoffbezogene
Akustikplatte mit
magnetischer
Unterstützung



- TP7
Caimi
Bianco Ghiaccio 8002



- TP8
Caimi
Giallo 3008



- TP9
Caimi
Nero 8033

T-Share

MADE IN ITALY

Tavolo T-Share Meeting/Operativo

L 2400 mm x P 1300 mm
x H 740 mm

Piano: Fenix

FX1 ○ bianco Malè
FX2 ● grigio Efeso
FX3 ● grigio London

Struttura: metallo

V1 ○ bianco RAL 9010
V16 ● manganese S051
V16 ● manganese S051

Canalina: metallo

V26 ● nero RAL 9005
V25 ● giallo RAL 1006
V25 ● giallo RAL 1006art.3H2401300 XBBN
art.3H2401300 XGAF
art.3H2401300 XGAC

Piano: MDF Perfect Sense

D1 ○ bianco
D2 ● grigio caldo
D3 ● nero opaco

Struttura: metallo

V1 ○ bianco RAL 9010
V16 ● manganese S051
V26 ● nero RAL 9005

Canalina: metallo

V1 ○ bianco RAL 9010
V25 ● giallo RAL 1006
V26 ● nero RAL 9005art.3H2401300 XM2C
art.3H2401300 XM3A
art.3H2401300 XM3N

Piano: melaminico

M1 ○ bianco
M2 ● grigio chiaro
MW1 ● acero

Struttura: metallo

V1 ○ bianco RAL 9010
V16 ● manganese S051
V26 ● nero RAL 9005

Canalina: metallo

V1 ○ bianco RAL 9010
V25 ● giallo RAL 1006
V26 ● nero RAL 9005art.3H2401300 XM3B
art.3H2401300 XM1G
art.3H2401300 XM1N

DESIGN 967 ARCH

Fronte

Fianco

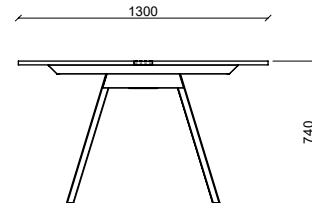
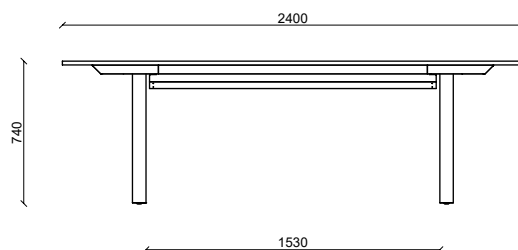
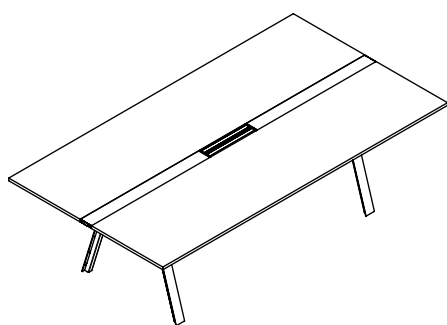

Copyright © dieffebi

T-Share

MADE IN ITALY

Tavolo T-Share Meeting/Operativo

L 2400 mm x P 1300 mm x H 740 mm

DESIGN 967 ARCH

DESCRIZIONE	Tavolo T-Share Meeting/Operativo	COLORI	<p>COLORI Struttura</p> <ul style="list-style-type: none"> > Disponibile in 2 colori standard V1 Bianco (RAL 9010) V16 Manganese <p>COLORI Canale</p> <ul style="list-style-type: none"> > Disponibile in 3 colori standard V25 Giallo (RAL 1006) V26 Nero (RAL 9005) V1 Bianco (RAL 9010) <p>COLORI PIANO</p> <ul style="list-style-type: none"> > Fenix disponibile in 3 colori standard FX1 Bianco (Malè); FX2 Grigio (Efeso); FX3 Grigio (London) > MDF Perfect Sense disponibile in 3 colori standard: D1 Bianco opaco; D2 Grigio caldo; D3 Nero opaco > Melaminico disponibile in 3 colori standard: M1 Bianco; M2 Grigio chiaro; MW1 Acero > Colori standard semilucidi > Colori personalizzabili su richiesta previa disponibilità e con sovrapprezzo: www.dieffebi.com/docs/299/2832/DFB_Colour-Chart-2020.pdf
DIMENSIONI	L 2400 mm x P 1300 mm x H 740 mm		
ESTERNE			
PRODUZIONE	<ul style="list-style-type: none"> > Dieffebi S.p.a. > Inizio produzione: anno 2019 > Luogo di produzione: Italia 		
MATERIALI	<ul style="list-style-type: none"> > struttura in metallo riciclato e riciclabile > piano in Fenix: alta resistenza al graffio e al calore, anti impronta, morbidezza al tatto, bassa riflessione della luce, riparabilità termica dei micrograffi, alta attività di abbattimento della carica batterica > Piano in MDF PerfectSense: in Premium Matt si distingue dalle altre superfici per mobili per le sue caratteristiche visive e tattili. La speciale proprietà anti-impronta riduce la formazione di impronte sulla superficie e rende la pulizia molto più semplice. Il design di tendenza, caldo e vellutato al tatto, invita a toccare la superficie > Melaminico: pannello ecologico in truciolare ricavato da legno di riciclo. Le superfici in nobilitato sono resistenti ed igieniche e non richiedono alcuna manutenzione particolare 		
FINITURA	<ul style="list-style-type: none"> > Verniciatura a polveri basso emissive (materiale inerte) > Esenti da metalli pesanti > Assenza di spigoli vivi e bordi taglienti > Finitura anti riflesso > Non contiene VOC 	ACCESSORI	<ul style="list-style-type: none"> > Pannello divisorio frontale in tessuto > Pannello divisorio laterale in tessuto
		PESO NETTO	103,00 Kg
		MANUTENZIONE	<ul style="list-style-type: none"> > Pulire con panno morbido > Non trattare le superfici con panni abrasivi
COMPONENTI STANDARD	<ul style="list-style-type: none"> > Top Access (1) in alluminio verniciato con doppio sportello e setole ritenuta cavi. > Canala raccogli cavi verniciata in tinta > Cover gamba per copertura passaggio cavo di alimentazione > Piedini regolabili H 10mm > Viti per assemblaggio 	IMBALLO	<ul style="list-style-type: none"> > volume: 0,79 m3 > imballo in scatola di cartone > Fornito smontato > N°colli: 9
		END OF USE	> Corredato di scheda di disassemblaggio per smaltimento
		GARANZIA	> Dieffebi garantisce che il prodotto è stato realizzato usando materiali di alta qualità - Vedi documento di garanzia.

T-Share

MADE IN ITALY

Tavolo T-Share Meeting/Operativo

L 2400 mm x P 1300 mm x H 740 mm

DESIGN 967ARCH

BENESSERE E AMBIENTE > Design "green" in accordo con gli standard LEED®, per progettare ed arredare ambienti ad alto contenuto di sostenibilità.



TEST FINITURA UNI EN ISO 2409:2013
STRUTTURA NSS UNI EN ISO 9227:2017
METALLO UNI EN 15187:2007EN ISO 1520:2006
 UNI EN ISO 6272-1:2013
 UNI EN 15185:2011
 UNI EN 15186:2012, met.B
 UNI 9300:2015
 EN 12720:2013
 EN 12721:2013
 UNI 9429:2015

CLASSE DI REAZIONE AL FUOCO > Struttura: Classe 0
 > Piano: Classe s1,d0



ADIMEMBER



Dieffebi SpA

via Palù 36
 San Vendemiano,
 31020 Treviso - Italia

T +39 0438 4715
 F +39 0438 471600
 exportsales@dieffebi.com
 vendite@dieffebi.com
 www.dieffebi.com

T-Share

Vernici
Varnish
Vernis
Lacke

Struttura
Frame
Piètement
Gestell



-V1
S711 (RAL 9010)
Pure white



-V16
S051
Manganese



-V26
S885 (RAL 9005)
Black opaco

Canalina
Cable duct
Goulotte pour
câblage
Kabelwanne



-V4
S708 (RAL 9010)
Pure white textured finish



-V25
S107 (RAL 1006)
Yellow



-V26
S885 (RAL 9005)
Black opaco

Fenix

Piano
Top
Plateau
Tischplatte

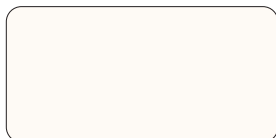

-FX1
Bianco/White /Blanc/Weiß – Malè



-FX2
Grigio/Grey/Gris/Grau – Efeso



-FX3
Grigio/Grey/Gris/Grau – London

MDF Perfect Sense

Piano
Top
Plateau
Tischplatte



-D1
Bianco opaco/Matt White
/Blanc mat/Matt weiß



-D2
Grigio caldo/Warm grey
/Gris chaud/Warmes Grau



-D3
Nero opaco/Matt black
/Noir mat/Mattschwarz

T-Share

Melaminico
Melamine
Mélaminé
Melamin

Piano
Top
Plateau
Tischplatte



-M1
Bianco/White/Blanc/Weiß



-M2
Grigio chiaro/Light grey
/Gris clair/Hellgrau



-MW1
Acero/Maple/Érable/Ahorn

Tessuti
Fabrics
Tissus
Textilien

Pannello acustico
completo
di supporto magnetico
Fabric acoustic panel
complete
with magnetic support
Panneau acoustique
avec support magnétique
Stoffbezogene
Akustikplatte mit
magnetischer
Unterstützung



- TP7
Caimi
Bianco Ghiaccio 8002



- TP8
Caimi
Giallo 3008



- TP9
Caimi
Nero 8033

T-Share

MADE IN ITALY

Tavolo T-Share Meeting/Operativo

L 2400 mm x P 1300 mm
x H 740 mm

Piano: Fenix

FX1 ○ bianco Malè

FX2 ● grigio Efeso

FX3 ● grigio London

Struttura: metallo

V1 ○ bianco RAL 9010

V16 ● manganese S051

V16 ● manganese S051

Canalina: metallo

V26 ● nero RAL 9005

V25 ● giallo RAL 1006

V25 ● giallo RAL 1006

art.3H24S1300 XBBN

art.3H24S1300 XGAF

art.3H24S1300 XGAC

Piano: MDF Perfect Sense

D1 ○ bianco

D2 ● grigio caldo

D3 ● nero opaco

Struttura: metallo

V1 ○ bianco RAL 9010

V16 ● manganese S051

V26 ● nero RAL 9005

Canalina: metallo

V1 ○ bianco RAL 9010

V25 ● giallo RAL 1006

V26 ● nero RAL 9005

art.3H24S1300 XM2C

art.3H24S1300 XM3A

art.3H24S1300 XM3N

Piano: melaminico

M1 ○ bianco

M2 ● grigio chiaro

MW1 ● acero

Struttura: metallo

V1 ○ bianco RAL 9010

V16 ● manganese S051

V26 ● nero RAL 9005

Canalina: metallo

V1 ○ bianco RAL 9010

V25 ● giallo RAL 1006

V26 ● nero RAL 9005

art.3H24S1300 XM3B

art.3H24S1300 XM1G

art.3H24S1300 XM1N

DESIGN 967 ARCH

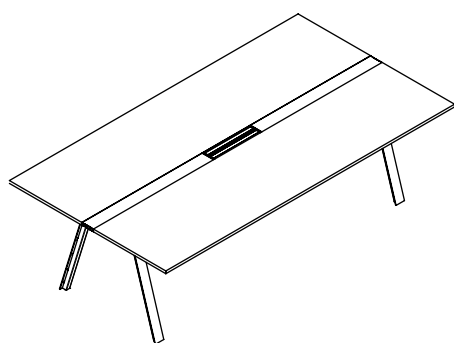

Fronte



Fianco

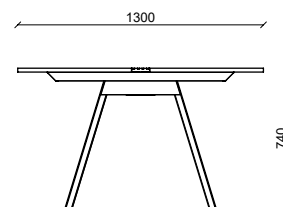

Copyright © dieffebi

Dieffebi SpA

T +39 0438 4715

F +39 0438 471600

exportsales@dieffebi.com

vendite@dieffebi.com

www.dieffebi.com

1 via Palù 36
San Vendemiano,
31020 Treviso - Italia

02 08 2021

T-Share

MADE IN ITALY

Tavolo T-Share Meeting/Operativo

L 2400 mm x P 1300 mm x H 740 mm

DESIGN 967 ARCH

DESCRIZIONE	Tavolo T-Share Meeting/Operativo	COLORI	COLORI Struttura > Disponibile in 2 colori standard V1 Bianco (RAL 9010) V16 Manganese COLORI Canale > Disponibile in 3 colori standard V25 Giallo (RAL 1006) V26 Nero (RAL 9005) V1 Bianco (RAL 9010) COLORI PIANO > Fenix disponibile in 3 colori standard FX1 Bianco (Malè); FX2 Grigio (Efeso); FX3 Grigio (London) > MDF Perfect Sense disponibile in 3 colori standard: D1 Bianco opaco; D2 Grigio caldo; D3 Nero opaco > Melaminico disponibile in 3 colori standard: M1 Bianco; M2 Grigio chiaro; MW1 Acero > Colori standard semilucidi > Colori personalizzabili su richiesta previa disponibilità e con sovrapprezzo: www.dieffebi.com/docs/299/2832/DFB_Colour-Chart-2020.pdf
DIMENSIONI ESTERNE	L 2400 mm x P 1300 mm x H 740 mm		
PRODUZIONE	> Dieffebi S.p.a. > Inizio produzione: anno 2019 > Luogo di produzione: Italia		
MATERIALI	> struttura in metallo riciclato e riciclabile > piano in Fenix: alta resistenza al graffio e al calore, anti impronta, morbidezza al tatto, bassa riflessione della luce, riparabilità termica dei micrograffi, alta attività di abbattimento della carica batterica > Piano in MDF PerfectSense: in Premium Matt si distingue dalle altre superfici per mobili per le sue caratteristiche visive e tattili. La speciale proprietà anti-impronta riduce la formazione di impronte sulla superficie e rende la pulizia molto più semplice. Il design di tendenza, caldo e vellutato al tatto, invita a toccare la superficie > Melaminico: pannello ecologico in truciolare ricavato da legno di riciclo. Le superfici in nobilitato sono resistenti ed igieniche e non richiedono alcuna manutenzione particolare	ACCESSORI	> Pannello divisorio frontale in tessuto > Pannello divisorio laterale in tessuto
FINITURA STRUTTURA	> Verniciatura a polveri basso emissive (materiale inerte) > Esenti da metalli pesanti > Assenza di spigoli vivi e bordi taglienti > Finitura anti riflesso > Non contiene VOC	PESO NETTO	105,00 Kg
COMPONENTI STANDARD	> Top Access (1) in alluminio verniciato con doppio sportello e setole ritenuta cavi. > Canala raccogli cavi verniciata in tinta > Cover gamba per copertura passaggio cavo di alimentazione > Piedini regolabili H 10mm > Viti per assemblaggio	MANUTENZIONE	> Pulire con panno morbido > Non trattare le superfici con panni abrasivi
		IMBALLO	> volume: 0,79 m3 > imballo in scatola di cartone > Fornito smontato > N°colli: 8
		END OF USE	> Corredato di scheda di disassemblaggio per smaltimento
		GARANZIA	> Dieffebi garantisce che il prodotto è stato realizzato usando materiali di alta qualità - Vedi documento di garanzia.

T-Share

MADE IN ITALY

Tavolo T-Share Meeting/Operativo

L 2400 mm x P 1300 mm x H 740 mm

DESIGN 967ARCH

BENESSERE E AMBIENTE > Design "green" in accordo con gli standard LEED®, per progettare ed arredare ambienti ad alto contenuto di sostenibilità.



TEST FINITURA	UNI EN ISO 2409:2013
STRUTTURA	NSS UNI EN ISO 9227:2017
METALLO	UNI EN 15187:2007EN ISO 1520:2006
	UNI EN ISO 6272-1:2013
	UNI EN 15185:2011
	UNI EN 15186:2012, met.B
	UNI 9300:2015
	EN 12720:2013
	EN 12721:2013
	UNI 9429:2015

- > Struttura: Classe 0
- > Piano: Classe s1,d0



ADIMEMBER



T-Share

Vernici
Varnish
Vernis
Lacke

Struttura
Frame
Piètement
Gestell



-V1
S711 (RAL 9010)
Pure white



-V16
S051
Manganese



-V26
S885 (RAL 9005)
Black opaco

Canalina
Cable duct
Goulotte pour
câblage
Kabelwanne



-V4
S708 (RAL 9010)
Pure white textured finish



-V25
S107 (RAL 1006)
Yellow



-V26
S885 (RAL 9005)
Black opaco

Fenix

Piano
Top
Plateau
Tischplatte

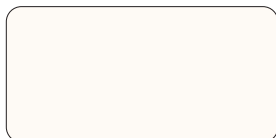

-FX1
Bianco/White /Blanc/Weiß – Malè



-FX2
Grigio/Grey/Gris/Grau – Efeso



-FX3
Grigio/Grey/Gris/Grau – London

MDF Perfect Sense

Piano
Top
Plateau
Tischplatte



-D1
Bianco opaco/Matt White
/Blanc mat/Matt weiß



-D2
Grigio caldo/Warm grey
/Gris chaud/Warmes Grau



-D3
Nero opaco/Matt black
/Noir mat/Mattschwarz

T-Share

Melaminico
Melamine
Mélaminé
Melamin

Piano
Top
Plateau
Tischplatte

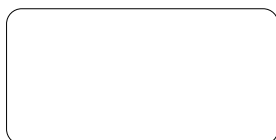

-M1
Bianco/White/Blanc/Weiß



-M2
Grigio chiaro/Light grey
/Gris clair/Hellgrau



-MW1
Acero/Maple/Érable/Ahorn

Tessuti
Fabrics
Tissus
Textilien

Pannello acustico
completo
di supporto magnetico
Fabric acoustic panel
complete
with magnetic support
Panneau acoustique
avec support magnétique
Stoffbezogene
Akustikplatte mit
magnetischer
Unterstützung



- TP7
Caimi
Bianco Ghiaccio 8002



- TP8
Caimi
Giallo 3008



- TP9
Caimi
Nero 8033

T-Share

MADE IN ITALY

Tavolo T-Share Meeting/Operativo

L 2780 mm x P 1300 mm
x H 740 mm

Piano: Fenix

FX1 ○ bianco Malè

FX2 ● grigio Efeso

FX3 ● grigio London

Struttura: metallo

V1 ○ bianco RAL 9010

V16 ● manganese S051

V16 ● manganese S051

Canalina: metallo

V26 ● nero RAL 9005

V25 ● giallo RAL 1006

V25 ● giallo RAL 1006

art.3H2801300 XBBN

art.3H2801300 XGAF

art.3H2801300 XGAC

Piano: MDF Perfect Sense

D1 ○ bianco

D2 ● grigio caldo

D3 ● nero opaco

Struttura: metallo

V1 ○ bianco RAL 9010

V16 ● manganese S051

V26 ● nero RAL 9005

Canalina: metallo

V1 ○ bianco RAL 9010

V25 ● giallo RAL 1006

V26 ● nero RAL 9005

art.3H2801300 XM2C

art.3H2801300 XM3A

art.3H2801300 XM3N

Piano: melaminico

M1 ○ bianco

M2 ● grigio chiaro

MW1 ● acero

Struttura: metallo

V1 ○ bianco RAL 9010

V16 ● manganese S051

V26 ● nero RAL 9005

Canalina: metallo

V1 ○ bianco RAL 9010

V25 ● giallo RAL 1006

V26 ● nero RAL 9005

art.3H2801300 XM3B

art.3H2801300 XM1G

art.3H2801300 XM1N

DESIGN 967 ARCH

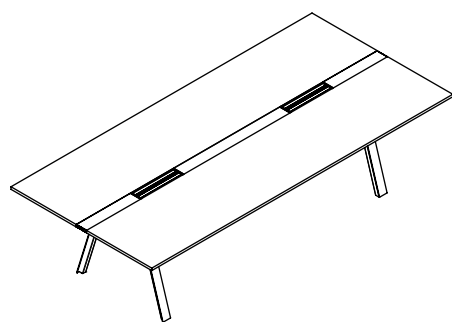

Fronte

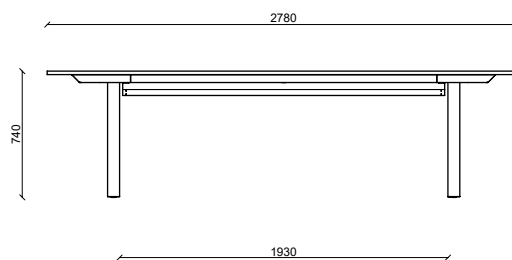

Fianco

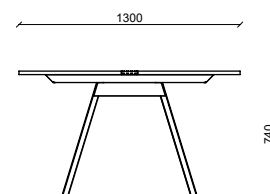

Dieffebi SpA

T +39 0438 4715

F +39 0438 471600

exportsales@dieffebi.com

vendite@dieffebi.com

www.dieffebi.com

T-Share

MADE IN ITALY

Tavolo T-Share Meeting/Operativo

L 2780 mm x P 1300 mm x H 740 mm

DESIGN 967 ARCH

DESCRIZIONE	Tavolo T-Share Meeting/Operativo	COLORI	<p>COLORI Struttura</p> <ul style="list-style-type: none"> > Disponibile in 2 colori standard V1 Bianco (RAL 9010) V16 Manganese <p>COLORI Canale</p> <ul style="list-style-type: none"> > Disponibile in 3 colori standard V25 Giallo (RAL 1006) V26 Nero (RAL 9005) V1 Bianco (RAL 9010) <p>COLORI PIANO</p> <ul style="list-style-type: none"> > Fenix disponibile in 3 colori standard FX1 Bianco (Malè); FX2 Grigio (Efeso); FX3 Grigio (London) > MDF Perfect Sense disponibile in 3 colori standard: D1 Bianco opaco; D2 Grigio caldo; D3 Nero opaco > Melaminico disponibile in 3 colori standard: M1 Bianco; M2 Grigio chiaro; MW1 Acero > Colori standard semilucidi > Colori personalizzabili su richiesta previa disponibilità e con sovrapprezzo: www.dieffebi.com/docs/299/2832/DFB_Colour-Chart-2020.pdf
DIMENSIONI	L 2780 mm x P 1300 mm x H 740 mm		
ESTERNE			
PRODUZIONE	<ul style="list-style-type: none"> > Dieffebi S.p.a. > Inizio produzione: anno 2019 > Luogo di produzione: Italia 		
MATERIALI	<ul style="list-style-type: none"> > struttura in metallo riciclato e riciclabile > piano in Fenix: alta resistenza al graffio e al calore, anti impronta, morbidezza al tatto, bassa riflessione della luce, riparabilità termica dei micrograffi, alta attività di abbattimento della carica batterica > Piano in MDF PerfectSense: in Premium Matt si distingue dalle altre superfici per mobili per le sue caratteristiche visive e tattili. La speciale proprietà anti-impronta riduce la formazione di impronte sulla superficie e rende la pulizia molto più semplice. Il design di tendenza, caldo e vellutato al tatto, invita a toccare la superficie > Melaminico: pannello ecologico in truciolare ricavato da legno di riciclo. Le superfici in nobilitato sono resistenti ed igieniche e non richiedono alcuna manutenzione particolare 		
FINITURA STRUTTURA	<ul style="list-style-type: none"> > Verniciatura a polveri basso emissive (materiale inerte) > Esenti da metalli pesanti > Assenza di spigoli vivi e bordi taglienti > Finitura anti riflesso > Non contiene VOC 	ACCESSORI	<ul style="list-style-type: none"> > Pannello divisorio frontale in tessuto > Pannello divisorio laterale in tessuto
COMPONENTI STANDARD	<ul style="list-style-type: none"> > Top Access (2) in alluminio verniciato con doppio sportello e setole ritenuta cavi. > Canala raccogli cavi verniciata in tinta > Cover gamba per copertura passaggio cavo di alimentazione > Piedini regolabili H 10mm > Viti per assemblaggio 	PESO NETTO	120,00 Kg
		MANUTENZIONE	<ul style="list-style-type: none"> > Pulire con panno morbido > Non trattare le superfici con panni abrasivi
		IMBALLO	<ul style="list-style-type: none"> > volume: 0,85 m³ > imballo in scatola di cartone > Fornito smontato > N°colli: 9
		END OF USE	> Corredato di scheda di disassemblaggio per smaltimento
		GARANZIA	> Dieffebi garantisce che il prodotto è stato realizzato usando materiali di alta qualità - Vedi documento di garanzia.

T-Share

MADE IN ITALY

Tavolo T-Share Meeting/Operativo

L 2780 mm x P 1300 mm x H 740 mm

DESIGN 967ARCH

BENESSERE E AMBIENTE > Design "green" in accordo con gli standard LEED®, per progettare ed arredare ambienti ad alto contenuto di sostenibilità.



www.GreenTop.com



TEST FINITURA UNI EN ISO 2409:2013
STRUTTURA NSS UNI EN ISO 9227:2017
METALLO UNI EN 15187:2007EN ISO 1520:2006
 UNI EN ISO 6272-1:2013
 UNI EN 15185:2011
 UNI EN 15186:2012, met.B
 UNI 9300:2015
 EN 12720:2013
 EN 12721:2013
 UNI 9429:2015

CLASSE DI REAZIONE AL FUOCO > Struttura: Classe 0
 > Piano: Classe s1,d0



dieffebi



MADE IN EUROPE



ASSUFFICIO
 ASSOCIAZIONE FIDELIUSGARRECO

ADIMEMBER



consip
 acquistinretepa.it
Il Fornitore degli Appalti Pubblici per l'edilizia

T-Share

Vernici
Varnish
Vernis
Lacke

Struttura
Frame
Piètement
Gestell



-V1
S711 (RAL 9010)
Pure white



-V16
S051
Manganese



-V26
S885 (RAL 9005)
Black opaco

Canalina
Cable duct
Goulotte pour
câblage
Kabelwanne



-V4
S708 (RAL 9010)
Pure white textured finish



-V25
S107 (RAL 1006)
Yellow



-V26
S885 (RAL 9005)
Black opaco

Fenix

Piano
Top
Plateau
Tischplatte

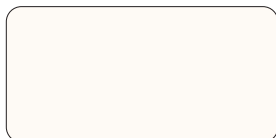

-FX1
Bianco/White /Blanc/Weiß – Malè



-FX2
Grigio/Grey/Gris/Grau – Efeso



-FX3
Grigio/Grey/Gris/Grau – London

MDF Perfect Sense

Piano
Top
Plateau
Tischplatte



-D1
Bianco opaco/Matt White
/Blanc mat/Matt weiß



-D2
Grigio caldo/Warm grey
/Gris chaud/Warmes Grau



-D3
Nero opaco/Matt black
/Noir mat/Mattschwarz

T-Share

Melaminico
Melamine
Mélaminé
Melamin

Piano
Top
Plateau
Tischplatte



-M1
Bianco/White/Blanc/Weiß



-M2
Grigio chiaro/Light grey
/Gris clair/Hellgrau



-MW1
Acero/Maple/Érable/Ahorn

Tessuti
Fabrics
Tissus
Textilien

Pannello acustico
completo
di supporto magnetico
Fabric acoustic panel
complete
with magnetic support
Panneau acoustique
avec support magnétique
Stoffbezogene
Akustikplatte mit
magnetischer
Unterstützung



- TP7
Caimi
Bianco Ghiaccio 8002



- TP8
Caimi
Giallo 3008



- TP9
Caimi
Nero 8033

T-Share

MADE IN ITALY

Tavolo T-Share Meeting/Operativo

L 2000 mm x P 900 mm
x H 740 mm

Piano: Fenix

FX1 ○ bianco Malè
FX2 ● grigio Efeso
FX3 ● grigio London

Struttura: metallo

V1 ○ bianco RAL 9010
V16 ● manganese S051
V16 ● manganese S051

Canalina: metallo

V26 ● nero RAL 9005
V25 ● giallo RAL 1006
V25 ● giallo RAL 1006art.3H2000900 XBBN
art.3H2000900 XGAF
art.3H2000900 XGAC

Piano: MDF Perfect Sense

D1 ○ bianco
D2 ● grigio caldo
D3 ● nero opaco

Struttura: metallo

V1 ○ bianco RAL 9010
V16 ● manganese S051
V26 ● nero RAL 9005

Canalina: metallo

V1 ○ bianco RAL 9010
V25 ● giallo RAL 1006
V26 ● nero RAL 9005art.3H2000900 XM2C
art.3H2000900 XM3A
art.3H2000900 XM3N

Piano: melaminico

M1 ○ bianco
M2 ● grigio chiaro
MW1 ● acero

Struttura: metallo

V1 ○ bianco RAL 9010
V16 ● manganese S051
V26 ● nero RAL 9005

Canalina: metallo

V1 ○ bianco RAL 9010
V25 ● giallo RAL 1006
V26 ● nero RAL 9005art.3H2000900 XM3B
art.3H2000900 XM1G
art.3H2000900 XM1N

DESIGN 967 ARCH

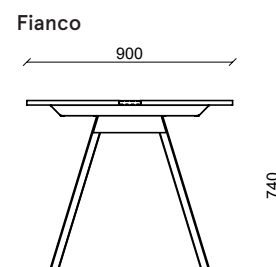
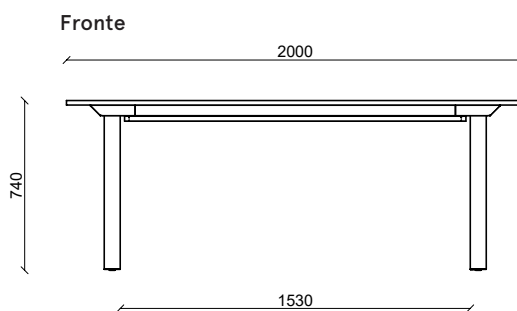
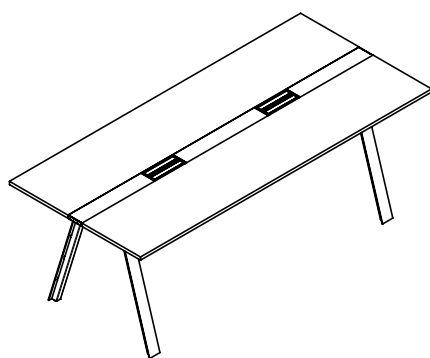

T-Share

MADE IN ITALY

Tavolo T-Share Meeting/Operativo

L 2000 mm x P 900 mm x H 740 mm

DESIGN 967 ARCH

DESCRIZIONE	Tavolo T-Share Meeting/Operativo	COLORI	<p>COLORI Struttura</p> <ul style="list-style-type: none"> > Disponibile in 2 colori standard V1 Bianco (RAL 9010) V16 Manganese <p>COLORI Canale</p> <ul style="list-style-type: none"> > Disponibile in 3 colori standard V25 Giallo (RAL 1006) V26 Nero (RAL 9005) V1 Bianco (RAL 9010) <p>COLORI PIANO</p> <ul style="list-style-type: none"> > Fenix disponibile in 3 colori standard FX1 Bianco (Malè); FX2 Grigio (Efeso); FX3 Grigio (London) > MDF Perfect Sense disponibile in 3 colori standard: D1 Bianco opaco; D2 Grigio caldo; D3 Nero opaco > Melaminico disponibile in 3 colori standard: M1 Bianco; M2 Grigio chiaro; MW1 Acero > Colori standard semilucidi > Colori personalizzabili su richiesta previa disponibilità e con sovrapprezzo: www.dieffebi.com/docs/299/2832/DFB_Colour-Chart-2020.pdf
DIMENSIONI ESTERNE	L 2000 mm x P 900 mm x H 740 mm		
PRODUZIONE	<ul style="list-style-type: none"> > Dieffebi S.p.a. > Inizio produzione: anno 2019 > Luogo di produzione: Italia 		
MATERIALI	<ul style="list-style-type: none"> > struttura in metallo riciclato e riciclabile > piano in Fenix: alta resistenza al graffio e al calore, anti impronta, morbidezza al tatto, bassa riflessione della luce, riparabilità termica dei micrograffi, alta attività di abbattimento della carica batterica > Piano in MDF PerfectSense: in Premium Matt si distingue dalle altre superfici per mobili per le sue caratteristiche visive e tattili. La speciale proprietà anti-impronta riduce la formazione di impronte sulla superficie e rende la pulizia molto più semplice. Il design di tendenza, caldo e vellutato al tatto, invita a toccare la superficie > Melaminico: pannello ecologico in truciolare ricavato da legno di riciclo. Le superfici in nobilitato sono resistenti ed igieniche e non richiedono alcuna manutenzione particolare 		
FINITURA STRUTTURA	<ul style="list-style-type: none"> > Verniciatura a polveri basso emissive (materiale inerte) > Esenti da metalli pesanti > Assenza di spigoli vivi e bordi taglienti > Finitura anti riflesso > Non contiene VOC 	ACCESSORI	<ul style="list-style-type: none"> > Pannello divisorio frontale in tessuto > Pannello divisorio laterale in tessuto
COMPONENTI STANDARD	<ul style="list-style-type: none"> > Top Access (2) in alluminio verniciato con doppio sportello e setole ritenuta cavi > Canala raccogli cavi verniciata in tinta > Cover gamba per copertura passaggio cavo di alimentazione > Piedini regolabili H 10 mm > Viti per assemblaggio 	PESO NETTO	69,00 Kg
		MANUTENZIONE	<ul style="list-style-type: none"> > Pulire con panno morbido > Non trattare le superfici con panni abrasivi
		IMBALLO	<ul style="list-style-type: none"> > volume: 0,60 m³ > imballo in scatola di cartone > Fornito smontato > N°colli: 7
		END OF USE	> Corredato di scheda di disassemblaggio per smaltimento
		GARANZIA	> Dieffebi garantisce che il prodotto è stato realizzato usando materiali di alta qualità - Vedi documento di garanzia.

T-Share

MADE IN ITALY

Tavolo T-Share Meeting/Operativo

L 2000 mm x P 900 mm x H 740 mm

DESIGN 967ARCH

BENESSERE E AMBIENTE > Design "green" in accordo con gli standard LEED®, per progettare ed arredare ambienti ad alto contenuto di sostenibilità.



TEST FINITURA UNI EN ISO 2409:2013
STRUTTURA NSS UNI EN ISO 9227:2017
METALLO UNI EN 15187:2007EN ISO 1520:2006
 UNI EN ISO 6272-1:2013
 UNI EN 15185:2011
 UNI EN 15186:2012, met.B
 UNI 9300:2015
 EN 12720:2013
 EN 12721:2013
 UNI 9429:2015

CLASSE DI REAZIONE AL FUOCO > Struttura: Classe 0
 > Piano: Classe s1,d0



ADIMEMBER



T-Share

Vernici
Varnish
Vernis
Lacke

Struttura
Frame
Piètement
Gestell



-V1
S711 (RAL 9010)
Pure white



-V16
S051
Manganese



-V26
S885 (RAL 9005)
Black opaco

Canalina
Cable duct
Goulotte pour
câblage
Kabelwanne



-V4
S708 (RAL 9010)
Pure white textured finish



-V25
S107 (RAL 1006)
Yellow



-V26
S885 (RAL 9005)
Black opaco

Fenix

Piano
Top
Plateau
Tischplatte

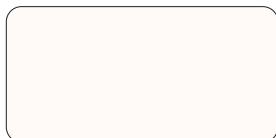

-FX1
Bianco/White /Blanc/Weiß – Malè



-FX2
Grigio/Grey/Gris/Grau – Efeso



-FX3
Grigio/Grey/Gris/Grau – London

MDF Perfect Sense

Piano
Top
Plateau
Tischplatte



-D1
Bianco opaco/Matt White
/Blanc mat/Matt weiß



-D2
Grigio caldo/Warm grey
/Gris chaud/Warmes Grau



-D3
Nero opaco/Matt black
/Noir mat/Mattschwarz

T-Share

Melaminico
Melamine
Mélaminé
Melamin

Piano
Top
Plateau
Tischplatte

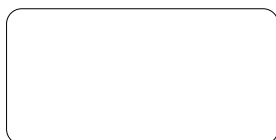

-M1
Bianco/White/Blanc/Weiß



-M2
Grigio chiaro/Light grey
/Gris clair/Hellgrau



-MW1
Acero/Maple/Érable/Ahorn

Tessuti
Fabrics
Tissus
Textilien

Pannello acustico
completo
di supporto magnetico
Fabric acoustic panel
complete
with magnetic support
Panneau acoustique
avec support magnétique
Stoffbezogene
Akustikplatte mit
magnetischer
Unterstützung



- TP7
Caimi
Bianco Ghiaccio 8002



- TP8
Caimi
Giallo 3008



- TP9
Caimi
Nero 8033

T-Share

MADE IN ITALY

Tavolo T-Share Meeting/Operativo

L 2400 mm x P 900 mm
x H 740 mm

Piano: Fenix

FX1 ○ bianco Malè
FX2 ● grigio Efeso
FX3 ● grigio London

Struttura: metallo

V1 ○ bianco RAL 9010
V16 ● manganese S051
V16 ● manganese S051

Canalina: metallo

V26 ● nero RAL 9005
V25 ● giallo RAL 1006
V25 ● giallo RAL 1006art.3H2400900 XBBN
art.3H2400900 XGAF
art.3H2400900 XGAC

Piano: MDF Perfect Sense

D1 ○ bianco
D2 ● grigio caldo
D3 ● nero opaco

Struttura: metallo

V1 ○ bianco RAL 9010
V16 ● manganese S051
V26 ● nero RAL 9005

Canalina: metallo

V1 ○ bianco RAL 9010
V25 ● giallo RAL 1006
V26 ● nero RAL 9005art.3H2400900 XM2C
art.3H2400900 XM3A
art.3H2400900 XM3N

Piano: melaminico

M1 ○ bianco
M2 ● grigio chiaro
MW1 ● acero

Struttura: metallo

V1 ○ bianco RAL 9010
V16 ● manganese S051
V26 ● nero RAL 9005

Canalina: metallo

V1 ○ bianco RAL 9010
V25 ● giallo RAL 1006
V26 ● nero RAL 9005art.3H2400900 XM3B
art.3H2400900 XM1G
art.3H2400900 XM1N

DESIGN 967 ARCH

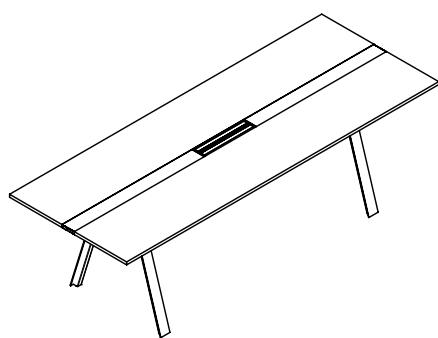

Fronte

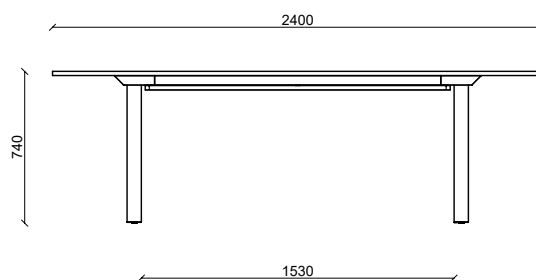

Fianco

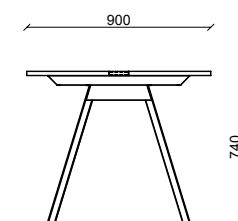

T-Share

MADE IN ITALY

Tavolo T-Share Meeting/Operativo

L 2400 mm x P 900 mm x H 740 mm

DESIGN 967 ARCH

DESCRIZIONE	Tavolo T-Share Meeting/Operativo	COLORI	<p>COLORI Struttura</p> <ul style="list-style-type: none"> > Disponibile in 2 colori standard V1 Bianco (RAL 9010) V16 Manganese <p>COLORI Canale</p> <ul style="list-style-type: none"> > Disponibile in 3 colori standard V25 Giallo (RAL 1006) V26 Nero (RAL 9005) V1 Bianco (RAL 9010) <p>COLORI PIANO</p> <ul style="list-style-type: none"> > Fenix disponibile in 3 colori standard FX1 Bianco (Malè); FX2 Grigio (Efeso); FX3 Grigio (London) > MDF Perfect Sense disponibile in 3 colori standard: D1 Bianco opaco; D2 Grigio caldo; D3 Nero opaco > Melaminico disponibile in 3 colori standard: M1 Bianco; M2 Grigio chiaro; MW1 Acero > Colori standard semilucidi > Colori personalizzabili su richiesta previa disponibilità e con sovrapprezzo: www.dieffebi.com/docs/299/2832/DFB_Colour-Chart-2020.pdf
DIMENSIONI ESTERNE	L 2400 mm x P 900 mm x H 740 mm		
PRODUZIONE	<ul style="list-style-type: none"> > Dieffebi S.p.a. > Inizio produzione: anno 2019 > Luogo di produzione: Italia 		
MATERIALI	<ul style="list-style-type: none"> > struttura in metallo riciclato e riciclabile > piano in Fenix: alta resistenza al graffio e al calore, anti impronta, morbidezza al tatto, bassa riflessione della luce, riparabilità termica dei micrograffi, alta attività di abbattimento della carica batterica > Piano in MDF PerfectSense: in Premium Matt si distingue dalle altre superfici per mobili per le sue caratteristiche visive e tattili. La speciale proprietà anti-impronta riduce la formazione di impronte sulla superficie e rende la pulizia molto più semplice. Il design di tendenza, caldo e vellutato al tatto, invita a toccare la superficie > Melaminico: pannello ecologico in truciolare ricavato da legno di riciclo. Le superfici in nobilitato sono resistenti ed igieniche e non richiedono alcuna manutenzione particolare 		
FINITURA STRUTTURA	<ul style="list-style-type: none"> > Verniciatura a polveri basso emissive (materiale inerte) > Esenti da metalli pesanti > Assenza di spigoli vivi e bordi taglienti > Finitura anti riflesso > Non contiene VOC 	ACCESSORI	<ul style="list-style-type: none"> > Pannello divisorio frontale in tessuto > Pannello divisorio laterale in tessuto
COMPONENTI STANDARD	<ul style="list-style-type: none"> > Top Access (1) in alluminio verniciato con doppio sportello e setole ritenuta cavi > Canala raccogli cavi verniciata in tinta > Cover gamba per copertura passaggio cavo di alimentazione > Piedini regolabili H 10 mm > Viti per assemblaggio 	PESO NETTO	74,00 Kg
		MANUTENZIONE	<ul style="list-style-type: none"> > Pulire con panno morbido > Non trattare le superfici con panni abrasivi
		IMBALLO	<ul style="list-style-type: none"> > volume: 0,62 m³ > imballo in scatola di cartone > Fornito smontato > N°colli: 7
		END OF USE	> Corredato di scheda di disassemblaggio per smaltimento
		GARANZIA	> Dieffebi garantisce che il prodotto è stato realizzato usando materiali di alta qualità - Vedi documento di garanzia.

T-Share

MADE IN ITALY

Tavolo T-Share Meeting/Operativo

L 2400 mm x P 900 mm x H 740 mm

DESIGN 967ARCH

BENESSERE E AMBIENTE > Design "green" in accordo con gli standard LEED®, per progettare ed arredare ambienti ad alto contenuto di sostenibilità.



www.GreenTop.com



TEST FINITURA UNI EN ISO 2409:2013
STRUTTURA NSS UNI EN ISO 9227:2017
METALLO UNI EN 15187:2007EN ISO 1520:2006
 UNI EN ISO 6272-1:2013
 UNI EN 15185:2011
 UNI EN 15186:2012, met.B
 UNI 9300:2015
 EN 12720:2013
 EN 12721:2013
 UNI 9429:2015

CLASSE DI REAZIONE AL FUOCO > Struttura: Classe 0
 > Piano: Classe s1,d0



dieffebi



MADE IN EUROPE



ASSUFFICIO
 ASSOCIAZIONE FEDERLEGGEDARREDO

ADIMEMBER



consip
 acquistinretepa.it
Il Fornitore degli Appalti Pubblici per l'edilizia

Dieffebi SpA

via Palù 36
 San Vendemiano,
 31020 Treviso - Italia

T +39 0438 4715
 F +39 0438 471600
 exportsales@dieffebi.com
 vendite@dieffebi.com
 www.dieffebi.com

T-Share

Vernici
Varnish
Vernis
Lacke

Struttura
Frame
Piètement
Gestell



-V1
S711 (RAL 9010)
Pure white



-V16
S051
Manganese



-V26
S885 (RAL 9005)
Black opaco

Canalina
Cable duct
Goulotte pour
câblage
Kabelwanne



-V4
S708 (RAL 9010)
Pure white textured finish



-V25
S107 (RAL 1006)
Yellow



-V26
S885 (RAL 9005)
Black opaco

Fenix

Piano
Top
Plateau
Tischplatte

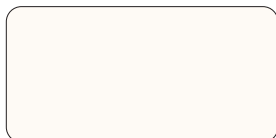

-FX1
Bianco/White /Blanc/Weiß – Malè



-FX2
Grigio/Grey/Gris/Grau – Efeso



-FX3
Grigio/Grey/Gris/Grau – London

MDF Perfect Sense

Piano
Top
Plateau
Tischplatte



-D1
Bianco opaco/Matt White
/Blanc mat/Matt weiß



-D2
Grigio caldo/Warm grey
/Gris chaud/Warmes Grau



-D3
Nero opaco/Matt black
/Noir mat/Mattschwarz

T-Share

Melaminico
Melamine
Mélaminé
Melamin

Piano
Top
Plateau
Tischplatte



-M1
Bianco/White/Blanc/Weiß



-M2
Grigio chiaro/Light grey
/Gris clair/Hellgrau



-MW1
Acero/Maple/Érable/Ahorn

Tessuti
Fabrics
Tissus
Textilien

Pannello acustico
completo
di supporto magnetico
Fabric acoustic panel
complete
with magnetic support
Panneau acoustique
avec support magnétique
Stoffbezogene
Akustikplatte mit
magnetischer
Unterstützung



- TP7
Caimi
Bianco Ghiaccio 8002



- TP8
Caimi
Giallo 3008



- TP9
Caimi
Nero 8033

T-Share

MADE IN ITALY

Tavolo T-Share Meeting/Operativo

L 2000 mm x P 900 mm
x H 1050 mm

Piano: Fenix

FX1 ○ bianco Malè

FX2 ● grigio Efeso

FX3 ● grigio London

Struttura: metallo

V1 ○ bianco RAL 9010

V16 ● manganese S051

V16 ● manganese S051

Canalina: metallo

V26 ● nero RAL 9005

V25 ● giallo RAL 1006

V25 ● giallo RAL 1006

art.3H200H900 XBBN

art.3H200H900 XGAF

art.3H200H900 XGAC

Piano: MDF Perfect Sense

D1 ○ bianco

D2 ● grigio caldo

D3 ● nero opaco

Struttura: metallo

V1 ○ bianco RAL 9010

V16 ● manganese S051

V26 ● nero RAL 9005

Canalina: metallo

V1 ○ bianco RAL 9010

V25 ● giallo RAL 1006

V26 ● nero RAL 9005

art.3H200H900 XM2C

art.3H200H900 XM3A

art.3H200H900 XM3N

Piano: melaminico

M1 ○ bianco

M2 ● grigio chiaro

MW1 ● acero

Struttura: metallo

V1 ○ bianco RAL 9010

V16 ● manganese S051

V26 ● nero RAL 9005

Canalina: metallo

V1 ○ bianco RAL 9010

V25 ● giallo RAL 1006

V26 ● nero RAL 9005

art.3H200H900 XM3B

art.3H200H900 XM1G

art.3H200H900 XM1N

DESIGN 967 ARCH



Fronte

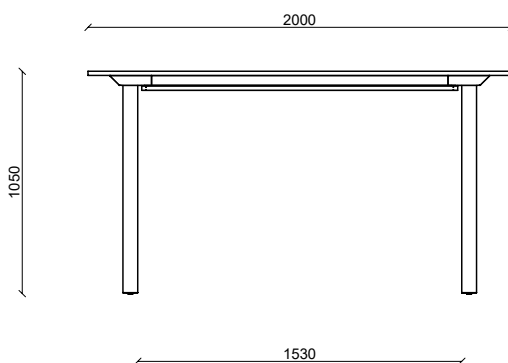

Fianco

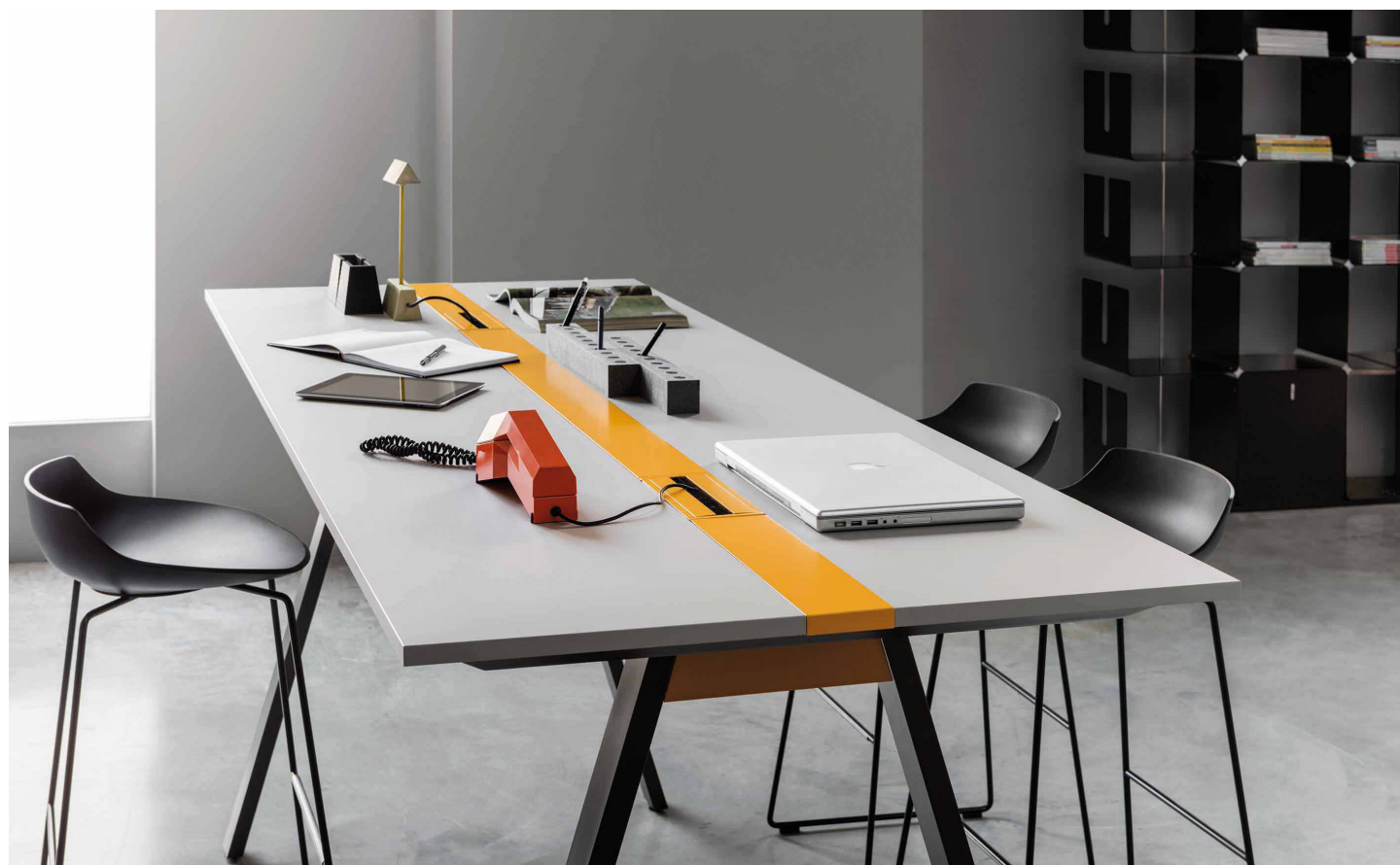
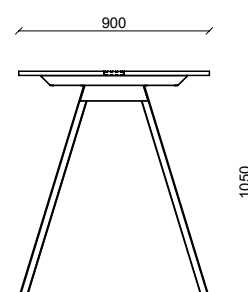

T-Share

MADE IN ITALY

Tavolo T-Share Meeting/Operativo

L 2000 mm x P 900 mm x H 1050 mm

DESIGN 967 ARCH

DESCRIZIONE	Tavolo T-Share Meeting/Operativo	COLORI	<p>COLORI Struttura</p> <ul style="list-style-type: none"> > Disponibile in 2 colori standard V1 Bianco (RAL 9010) V16 Manganese <p>COLORI Canale</p> <ul style="list-style-type: none"> > Disponibile in 3 colori standard V25 Giallo (RAL 1006) V26 Nero (RAL 9005) V1 Bianco (RAL 9010) <p>COLORI PIANO</p> <ul style="list-style-type: none"> > Fenix disponibile in 3 colori standard FX1 Bianco (Malè); FX2 Grigio (Efeso); FX3 Grigio (London) > MDF Perfect Sense disponibile in 3 colori standard: D1 Bianco opaco; D2 Grigio caldo; D3 Nero opaco > Melaminico disponibile in 3 colori standard: M1 Bianco; M2 Grigio chiaro; MW1 Acero > Colori standard semilucidi > Colori personalizzabili su richiesta previa disponibilità e con sovrapprezzo: www.dieffebi.com/docs/299/2832/DFB_Colour-Chart-2020.pdf
DIMENSIONI	L 2000 mm x P 900 mm x H 1050 mm		
ESTERNE			
PRODUZIONE	<ul style="list-style-type: none"> > Dieffebi S.p.a. > Inizio produzione: anno 2019 > Luogo di produzione: Italia 		
MATERIALI	<ul style="list-style-type: none"> > struttura in metallo riciclato e riciclabile > piano in Fenix: alta resistenza al graffio e al calore, anti impronta, morbidezza al tatto, bassa riflessione della luce, riparabilità termica dei micrograffi, alta attività di abbattimento della carica batterica > Piano in MDF PerfectSense: in Premium Matt si distingue dalle altre superfici per mobili per le sue caratteristiche visive e tattili. La speciale proprietà anti-impronta riduce la formazione di impronte sulla superficie e rende la pulizia molto più semplice. Il design di tendenza, caldo e vellutato al tatto, invita a toccare la superficie > Melaminico: pannello ecologico in truciolare ricavato da legno di riciclo. Le superfici in nobilitato sono resistenti ed igieniche e non richiedono alcuna manutenzione particolare 		
FINITURA STRUTTURA	<ul style="list-style-type: none"> > Verniciatura a polveri basso emissive (materiale inerte) > Esenti da metalli pesanti > Assenza di spigoli vivi e bordi taglienti > Finitura anti riflesso > Non contiene VOC 	ACCESSORI	<ul style="list-style-type: none"> > Pannello divisorio frontale in tessuto > Pannello divisorio laterale in tessuto
COMPONENTI STANDARD	<ul style="list-style-type: none"> > Top Access (2) in alluminio verniciato con doppio sportello e setole ritenuta cavi > Canala raccogli cavi verniciata in tinta > Cover gamba per copertura passaggio cavo di alimentazione > Piedini regolabili H 10 mm > Viti per assemblaggio 	PESO NETTO	72,00 Kg
		MANUTENZIONE	<ul style="list-style-type: none"> > Pulire con panno morbido > Non trattare le superfici con panni abrasivi
		IMBALLO	<ul style="list-style-type: none"> > volume: 0,68 m³ > imballo in scatola di cartone > Fornito smontato > N°colli: 7
		END OF USE	> Corredato di scheda di disassemblaggio per smaltimento
		GARANZIA	> Dieffebi garantisce che il prodotto è stato realizzato usando materiali di alta qualità - Vedi documento di garanzia.

T-Share

MADE IN ITALY

Tavolo T-Share Meeting/Operativo

L 2000 mm x P 900 mm x H 1050 mm

DESIGN 967ARCH

BENESSERE E AMBIENTE > Design "green" in accordo con gli standard LEED®, per progettare ed arredare ambienti ad alto contenuto di sostenibilità.



www.GreenTop.com



TEST FINITURA UNI EN ISO 2409:2013
STRUTTURA NSS UNI EN ISO 9227:2017
METALLO UNI EN 15187:2007EN ISO 1520:2006
 UNI EN ISO 6272-1:2013
 UNI EN 15185:2011
 UNI EN 15186:2012, met.B
 UNI 9300:2015
 EN 12720:2013
 EN 12721:2013
 UNI 9429:2015

CLASSE DI REAZIONE AL FUOCO > Struttura: Classe 0
 > Piano: Classe s1,d0



dieffebi



MADE IN EUROPE

ASSUFFICIO
ASSOCIAZIONE FIDELIENEGARRECO

ADIMEMBER

consip
acquistinretepa.it
Il Fornitore degli Appalti Pubblici per l'edilizia
www.acquistinretepa.it

T-Share

Vernici
Varnish
Vernis
Lacke

Struttura
Frame
Piètement
Gestell



-V1
S711 (RAL 9010)
Pure white



-V16
S051
Manganese



-V26
S885 (RAL 9005)
Black opaco

Canalina
Cable duct
Goulotte pour
câblage
Kabelwanne



-V4
S708 (RAL 9010)
Pure white textured finish



-V25
S107 (RAL 1006)
Yellow



-V26
S885 (RAL 9005)
Black opaco

Fenix

Piano
Top
Plateau
Tischplatte

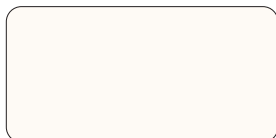

-FX1
Bianco/White /Blanc/Weiß – Malè



-FX2
Grigio/Grey/Gris/Grau – Efeso



-FX3
Grigio/Grey/Gris/Grau – London

MDF Perfect Sense

Piano
Top
Plateau
Tischplatte



-D1
Bianco opaco/Matt White
/Blanc mat/Matt weiß



-D2
Grigio caldo/Warm grey
/Gris chaud/Warmes Grau



-D3
Nero opaco/Matt black
/Noir mat/Mattschwarz

T-Share

Melaminico
Melamine
Mélaminé
Melamin

Piano
Top
Plateau
Tischplatte



-M1
Bianco/White/Blanc/Weiß



-M2
Grigio chiaro/Light grey
/Gris clair/Hellgrau



-MW1
Acero/Maple/Érable/Ahorn

Tessuti
Fabrics
Tissus
Textilien

Pannello acustico
completo
di supporto magnetico
Fabric acoustic panel
complete
with magnetic support
Panneau acoustique
avec support magnétique
Stoffbezogene
Akustikplatte mit
magnetischer
Unterstützung



- TP7
Caimi
Bianco Ghiaccio 8002



- TP8
Caimi
Giallo 3008



- TP9
Caimi
Nero 8033

T-Share

MADE IN ITALY

Tavolo T-Share Meeting/Operativo

L 4400 mm x P 1300 mm
x H 740 mm

Piano: Fenix

FX1 ○ bianco Malè
FX2 ● grigio Efeso
FX3 ● grigio London

Struttura: metallo

V1 ○ bianco RAL 9010
V16 ● manganese S051
V16 ● manganese S051

Canalina: metallo

V26 ● nero RAL 9005
V25 ● giallo RAL 1006
V25 ● giallo RAL 1006art.3HK204400 XBBN
art.3HK204400 XGAF
art.3HK204400 XGAC

Piano: MDF Perfect Sense

D1 ○ bianco
D2 ● grigio caldo
D3 ● nero opaco

Struttura: metallo

V1 ○ bianco RAL 9010
V16 ● manganese S051
V26 ● nero RAL 9005

Canalina: metallo

V1 ○ bianco RAL 9010
V25 ● giallo RAL 1006
V26 ● nero RAL 9005art.3HK204400 XM2C
art.3HK204400 XM3A
art.3HK204400 XM3N

Piano: melaminico

M1 ○ bianco
M2 ● grigio chiaro
MW1 ● acero

Struttura: metallo

V1 ○ bianco RAL 9010
V16 ● manganese S051
V26 ● nero RAL 9005

Canalina: metallo

V1 ○ bianco RAL 9010
V25 ● giallo RAL 1006
V26 ● nero RAL 9005art.3HK204400 XM3B
art.3HK204400 XM1G
art.3HK204400 XM1N

DESIGN 967 ARCH

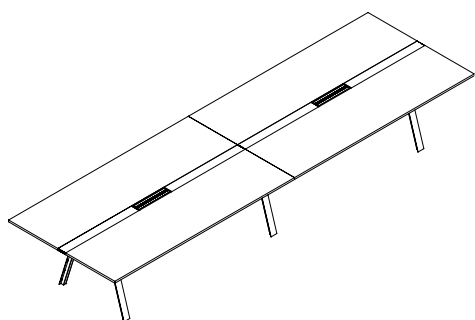

Fronte

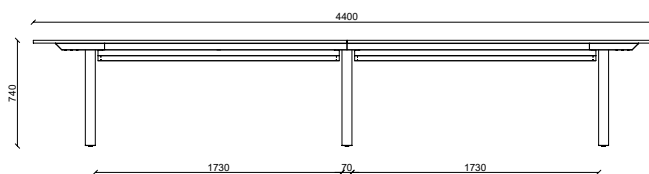

Fianco

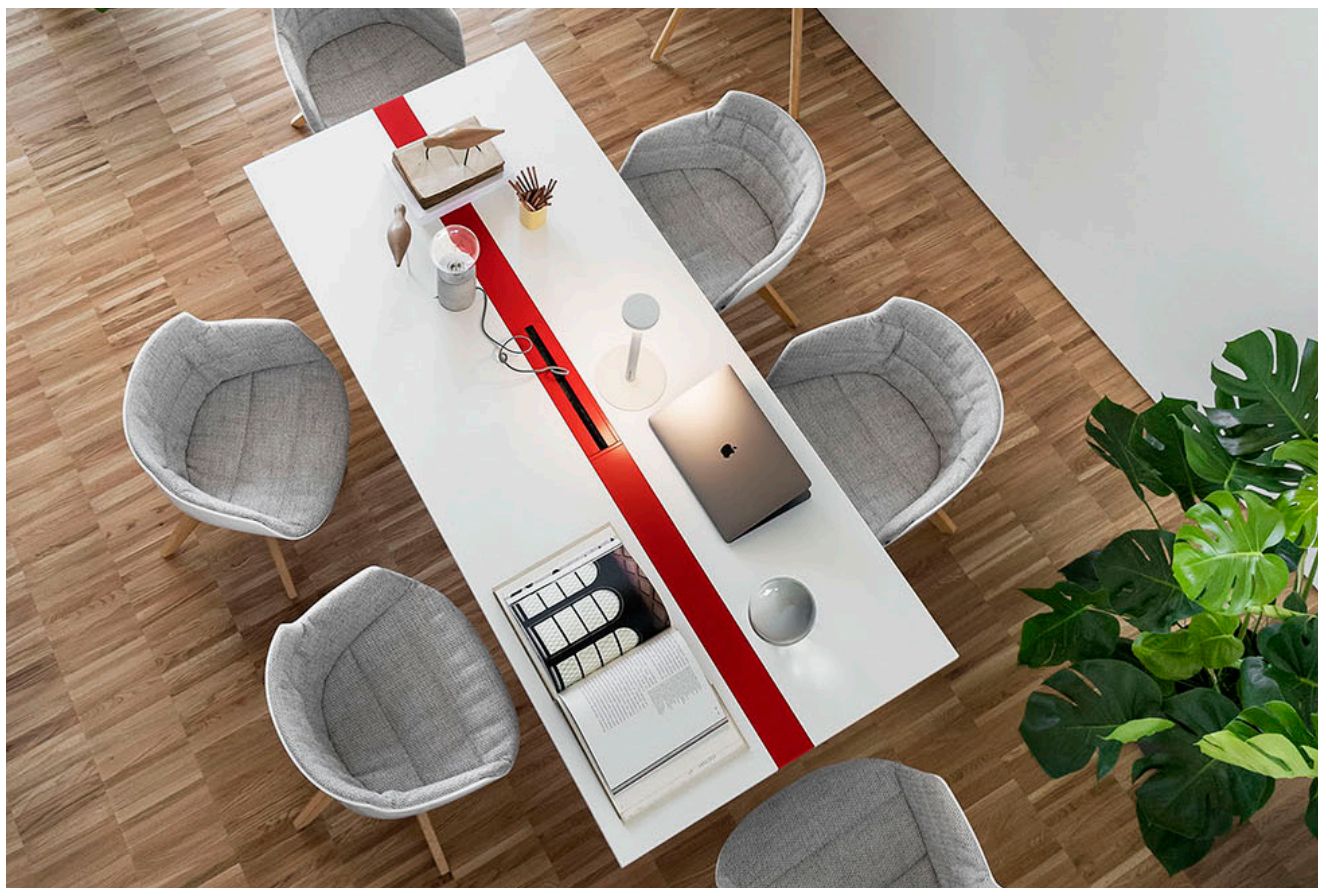
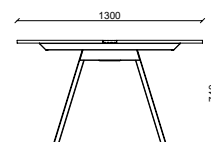

T-Share

MADE IN ITALY

Tavolo T-Share Meeting/Operativo

L 4400 mm x P 1300 mm x H 740 mm

DESIGN 967 ARCH

DESCRIZIONE	Tavolo T-Share Meeting/Operativo	COLORI	<p>COLORI Struttura</p> <ul style="list-style-type: none"> > Disponibile in 2 colori standard V1 Bianco (RAL 9010) V16 Manganese <p>COLORI Canale</p> <ul style="list-style-type: none"> > Disponibile in 3 colori standard V25 Giallo (RAL 1006) V26 Nero (RAL 9005) V1 Bianco (RAL 9010) <p>COLORI PIANO</p> <ul style="list-style-type: none"> > Fenix disponibile in 3 colori standard FX1 Bianco (Malè); FX2 Grigio (Efeso); FX3 Grigio (London) > MDF Perfect Sense disponibile in 3 colori standard: D1 Bianco opaco; D2 Grigio caldo; D3 Nero opaco > Melaminico disponibile in 3 colori standard: M1 Bianco; M2 Grigio chiaro; MW1 Acero > Colori standard semilucidi > Colori personalizzabili su richiesta previa disponibilità e con sovrapprezzo: www.dieffebi.com/docs/299/2832/DFB_Colour-Chart-2020.pdf
DIMENSIONI	L 4400 mm x P 1300 mm x H 740 mm		
ESTERNE			
PRODUZIONE	<ul style="list-style-type: none"> > Dieffebi S.p.a. > Inizio produzione: anno 2019 > Luogo di produzione: Italia 		
MATERIALI	<ul style="list-style-type: none"> > struttura in metallo riciclato e riciclabile > piano in Fenix: alta resistenza al graffio e al calore, anti impronta, morbidezza al tatto, bassa riflessione della luce, riparabilità termica dei micrograffi, alta attività di abbattimento della carica batterica > Piano in MDF PerfectSense: in Premium Matt si distingue dalle altre superfici per mobili per le sue caratteristiche visive e tattili. La speciale proprietà anti-impronta riduce la formazione di impronte sulla superficie e rende la pulizia molto più semplice. Il design di tendenza, caldo e vellutato al tatto, invita a toccare la superficie > Melaminico: pannello ecologico in truciolare ricavato da legno di riciclo. Le superfici in nobilitato sono resistenti ed igieniche e non richiedono alcuna manutenzione particolare 		
FINITURA STRUTTURA	<ul style="list-style-type: none"> > Verniciatura a polveri basso emissive (materiale inerte) > Esenti da metalli pesanti > Assenza di spigoli vivi e bordi taglienti > Finitura anti riflesso > Non contiene VOC 	ACCESSORI	<ul style="list-style-type: none"> > Pannello divisorio frontale in tessuto > Pannello divisorio laterale in tessuto
COMPONENTI STANDARD	<ul style="list-style-type: none"> > Top Access (2) in alluminio verniciato con doppio sportello e setole ritenuta cavi > Canala raccogli cavi verniciata in tinta > Cover gamba per copertura passaggio cavo di alimentazione > Piedini regolabili H 10 mm > Viti per assemblaggio 	PESO NETTO	182,00 Kg
		MANUTENZIONE	<ul style="list-style-type: none"> > Pulire con panno morbido > Non trattare le superfici con panni abrasivi
		IMBALLO	<ul style="list-style-type: none"> > volume: 1,1 m3 > imballo in scatola di cartone > Fornito smontato > N°colli: 15
		END OF USE	> Corredato di scheda di disassemblaggio per smaltimento
		GARANZIA	> Dieffebi garantisce che il prodotto è stato realizzato usando materiali di alta qualità - Vedi documento di garanzia.

T-Share

MADE IN ITALY

Tavolo T-Share Meeting/Operativo

L 4400 mm x P 1300 mm x H 740 mm

DESIGN 967ARCH

BENESSERE E AMBIENTE > Design "green" in accordo con gli standard LEED®, per progettare ed arredare ambienti ad alto contenuto di sostenibilità.



TEST FINITURA UNI EN ISO 2409:2013
STRUTTURA NSS UNI EN ISO 9227:2017
METALLO UNI EN 15187:2007EN ISO 1520:2006
 UNI EN ISO 6272-1:2013
 UNI EN 15185:2011
 UNI EN 15186:2012, met.B
 UNI 9300:2015
 EN 12720:2013
 EN 12721:2013
 UNI 9429:2015

CLASSE DI REAZIONE AL FUOCO > Struttura: Classe 0
 > Piano: Classe s1,d0



ADIMEMBER



T-Share

Vernici
Varnish
Vernis
Lacke

Struttura
Frame
Piètement
Gestell



-V1
S711 (RAL 9010)
Pure white



-V16
S051
Manganese



-V26
S885 (RAL 9005)
Black opaco

Canalina
Cable duct
Goulotte pour
câblage
Kabelwanne



-V4
S708 (RAL 9010)
Pure white textured finish



-V25
S107 (RAL 1006)
Yellow



-V26
S885 (RAL 9005)
Black opaco

Fenix

Piano
Top
Plateau
Tischplatte

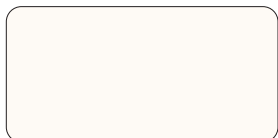

-FX1
Bianco/White /Blanc/Weiß – Malè



-FX2
Grigio/Grey/Gris/Grau – Efeso



-FX3
Grigio/Grey/Gris/Grau – London

MDF Perfect Sense

Piano
Top
Plateau
Tischplatte



-D1
Bianco opaco/Matt White
/Blanc mat/Matt weiß



-D2
Grigio caldo/Warm grey
/Gris chaud/Warmes Grau



-D3
Nero opaco/Matt black
/Noir mat/Mattschwarz

T-Share

Melaminico
Melamine
Mélaminé
Melamin

Piano
Top
Plateau
Tischplatte



-M1
Bianco/White/Blanc/Weiß



-M2
Grigio chiaro/Light grey
/Gris clair/Hellgrau



-MW1
Acero/Maple/Érable/Ahorn

Tessuti
Fabrics
Tissus
Textilien

Pannello acustico
completo
di supporto magnetico
Fabric acoustic panel
complete
with magnetic support
Panneau acoustique
avec support magnétique
Stoffbezogene
Akustikplatte mit
magnetischer
Unterstützung



- TP7
Caimi
Bianco Ghiaccio 8002



- TP8
Caimi
Giallo 3008



- TP9
Caimi
Nero 8033

T-Share

MADE IN ITALY

Tavolo T-Share Meeting/Operativo

L 6600 mm x P 1300 mm
x H 740 mm

Piano: Fenix

FX1 ○ bianco Malè
FX2 ● grigio Efeso
FX3 ● grigio London

Struttura: metallo

V1 ○ bianco RAL 9010
V16 ● manganese S051
V16 ● manganese S051

Canalina: metallo

V26 ● nero RAL 9005
V25 ● giallo RAL 1006
V25 ● giallo RAL 1006art.3HK306600 XBBN
art.3HK306600 XGAF
art.3HK306600 XGAC

Piano: MDF Perfect Sense

D1 ○ bianco
D2 ● grigio caldo
D3 ● nero opaco

Struttura: metallo

V1 ○ bianco RAL 9010
V16 ● manganese S051
V26 ● nero RAL 9005

Canalina: metallo

V1 ○ bianco RAL 9010
V25 ● giallo RAL 1006
V26 ● nero RAL 9005art.3HK306600 XM2C
art.3HK306600 XM3A
art.3HK306600 XM3N

Piano: melaminico

M1 ○ bianco
M2 ● grigio chiaro
MW1 ● acero

Struttura: metallo

V1 ○ bianco RAL 9010
V16 ● manganese S051
V26 ● nero RAL 9005

Canalina: metallo

V1 ○ bianco RAL 9010
V25 ● giallo RAL 1006
V26 ● nero RAL 9005art.3HK306600 XM3B
art.3HK306600 XM1G
art.3HK306600 XM1N

DESIGN 967 ARCH

Fronte

Fianco

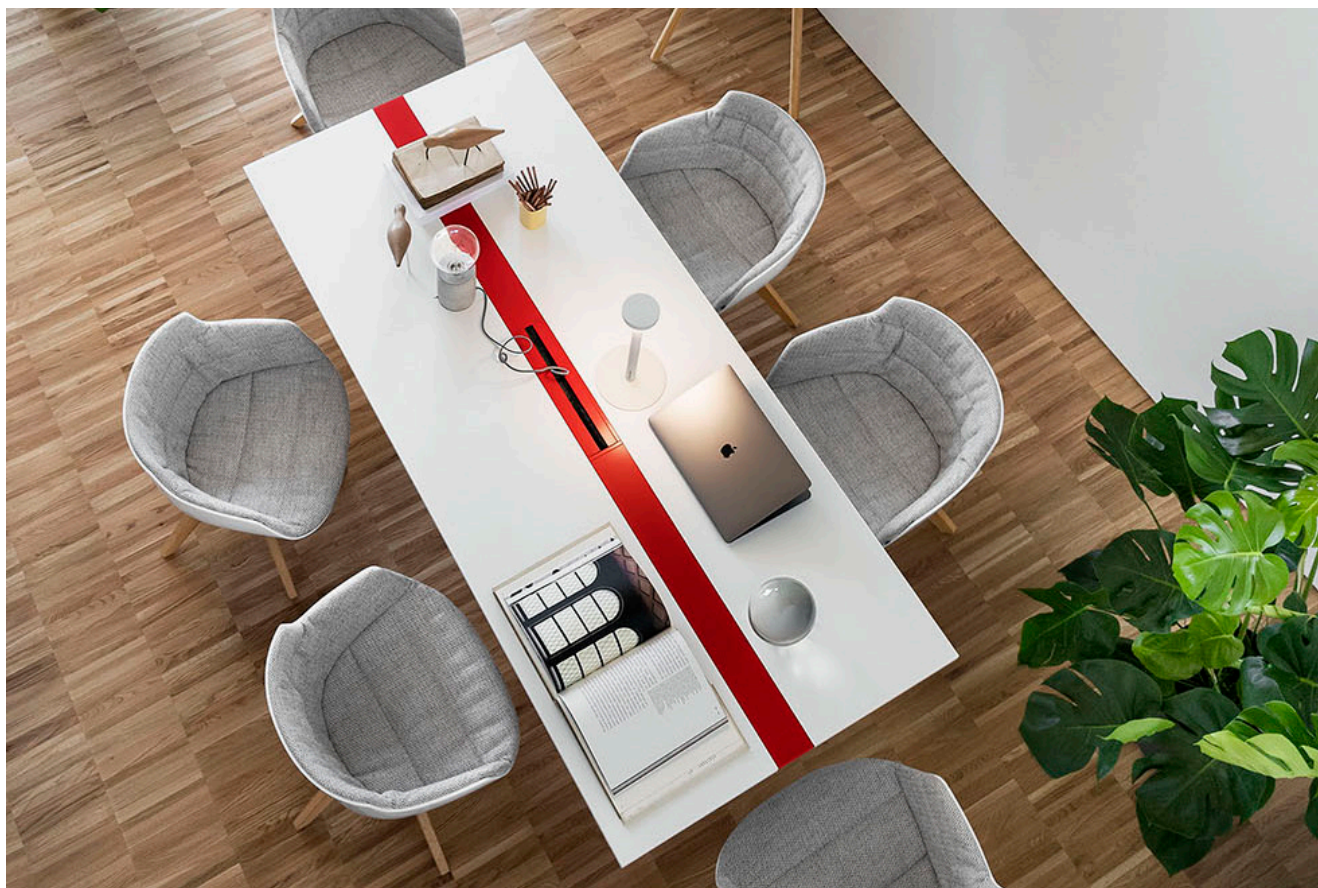
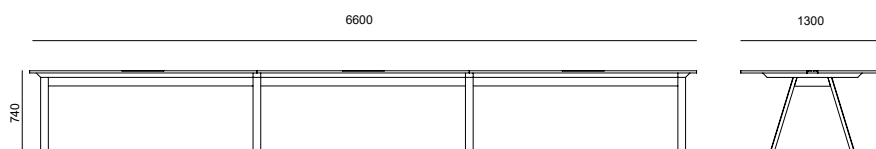
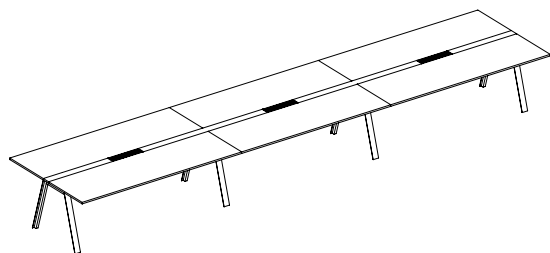

T-Share

MADE IN ITALY

Tavolo T-Share Meeting/Operativo

L 6600 mm x P 1300 mm x H 740 mm

DESIGN 967 ARCH

DESCRIZIONE	Tavolo T-Share Meeting/Operativo	COLORI	<p>COLORI Struttura</p> <ul style="list-style-type: none"> > Disponibile in 2 colori standard V1 Bianco (RAL 9010) V16 Manganese <p>COLORI Canale</p> <ul style="list-style-type: none"> > Disponibile in 3 colori standard V25 Giallo (RAL 1006) V26 Nero (RAL 9005) V1 Bianco (RAL 9010) <p>COLORI PIANO</p> <ul style="list-style-type: none"> > Fenix disponibile in 3 colori standard FX1 Bianco (Malè); FX2 Grigio (Efeso); FX3 Grigio (London) > MDF Perfect Sense disponibile in 3 colori standard: D1 Bianco opaco; D2 Grigio caldo; D3 Nero opaco > Melaminico disponibile in 3 colori standard: M1 Bianco; M2 Grigio chiaro; MW1 Acero > Colori standard semilucidi > Colori personalizzabili su richiesta previa disponibilità e con sovrapprezzo: www.dieffebi.com/docs/299/2832/DFB_Colour-Chart-2020.pdf
DIMENSIONI ESTERNE	L 6600 mm x P 1300 mm x H 740 mm		
PRODUZIONE	<ul style="list-style-type: none"> > Dieffebi S.p.a. > Inizio produzione: anno 2019 > Luogo di produzione: Italia 		
MATERIALI	<ul style="list-style-type: none"> > struttura in metallo riciclato e riciclabile > piano in Fenix: alta resistenza al graffio e al calore, anti impronta, morbidezza al tatto, bassa riflessione della luce, riparabilità termica dei micrograffi, alta attività di abbattimento della carica batterica > Piano in MDF PerfectSense: in Premium Matt si distingue dalle altre superfici per mobili per le sue caratteristiche visive e tattili. La speciale proprietà anti-impronta riduce la formazione di impronte sulla superficie e rende la pulizia molto più semplice. Il design di tendenza, caldo e vellutato al tatto, invita a toccare la superficie > Melaminico: pannello ecologico in truciolare ricavato da legno di riciclo. Le superfici in nobilitato sono resistenti ed igieniche e non richiedono alcuna manutenzione particolare 		
FINITURA STUTTURA	<ul style="list-style-type: none"> > Verniciatura a polveri basso emissive (materiale inerte) > Esenti da metalli pesanti > Assenza di spigoli vivi e bordi taglienti > Finitura anti riflesso > Non contiene VOC 	ACCESSORI	<ul style="list-style-type: none"> > Pannello divisorio frontale in tessuto > Pannello divisorio laterale in tessuto
COMPONENTI STANDARD	<ul style="list-style-type: none"> > Top Access (3) in alluminio verniciato con doppio sportello e setole ritenuta cavi > Canala raccogli cavi verniciata in tinta > Cover gamba per copertura passaggio cavo di alimentazione > Piedini regolabili H 10 mm > Viti per assemblaggio 	PESO NETTO	270,00 Kg
		MANUTENZIONE	<ul style="list-style-type: none"> > Pulire con panno morbido > Non trattare le superfici con panni abrasivi
		IMBALLO	<ul style="list-style-type: none"> > volume: 1,5 m3 > imballo in scatola di cartone > Fornito smontato > N°colli: 21
		END OF USE	> Corredato di scheda di disassemblaggio per smaltimento
		GARANZIA	> Dieffebi garantisce che il prodotto è stato realizzato usando materiali di alta qualità - Vedi documento di garanzia.

T-Share

MADE IN ITALY

Tavolo T-Share Meeting/Operativo

L 6600 mm x P 1300 mm x H 740 mm

DESIGN 967ARCH

BENESSERE E AMBIENTE > Design "green" in accordo con gli standard LEED®, per progettare ed arredare ambienti ad alto contenuto di sostenibilità.



www.GreenTop.com



TEST FINITURA	UNI EN ISO 2409:2013
STRUTTURA	NSS UNI EN ISO 9227:2017
METALLO	UNI EN 15187:2007EN ISO 1520:2006
	UNI EN ISO 6272-1:2013
	UNI EN 15185:2011
	UNI EN 15186:2012, met.B
	UNI 9300:2015
	EN 12720:2013
	EN 12721:2013
	UNI 9429:2015

CLASSE DI REAZIONE AL FUOCO > Struttura: Classe 0
> Piano: Classe s1,d0



dieffebi



MADE IN EUROPE



ASSUFFICIO
ASSOCIAZIONE FEDERLEGGIDARREDICI

ADIMEMBER



consip
acquistinretepa.it
Il Portale degli Appalti della Pubblica Amministrazione

T-Share

Vernici
Varnish
Vernis
Lacke

Struttura
Frame
Piètement
Gestell



-V1
S711 (RAL 9010)
Pure white



-V16
S051
Manganese



-V26
S885 (RAL 9005)
Black opaco

Canalina
Cable duct
Goulotte pour
câblage
Kabelwanne



-V4
S708 (RAL 9010)
Pure white textured finish



-V25
S107 (RAL 1006)
Yellow



-V26
S885 (RAL 9005)
Black opaco

Fenix

Piano
Top
Plateau
Tischplatte

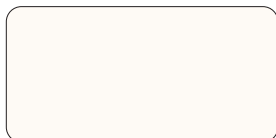

-FX1
Bianco/White /Blanc/Weiß – Malè



-FX2
Grigio/Grey/Gris/Grau – Efeso



-FX3
Grigio/Grey/Gris/Grau – London

MDF Perfect Sense

Piano
Top
Plateau
Tischplatte



-D1
Bianco opaco/Matt White
/Blanc mat/Matt weiß



-D2
Grigio caldo/Warm grey
/Gris chaud/Warmes Grau



-D3
Nero opaco/Matt black
/Noir mat/Mattschwarz

T-Share

Melaminico
Melamine
Mélaminé
Melamin

Piano
Top
Plateau
Tischplatte

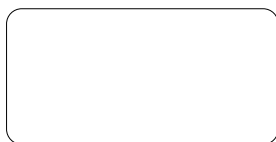

-M1
Bianco/White/Blanc/Weiß



-M2
Grigio chiaro/Light grey
/Gris clair/Hellgrau



-MW1
Acero/Maple/Érable/Ahorn

Tessuti
Fabrics
Tissus
Textilien

Pannello acustico
completo
di supporto magnetico
Fabric acoustic panel
complete
with magnetic support
Panneau acoustique
avec support magnétique
Stoffbezogene
Akustikplatte mit
magnetischer
Unterstützung

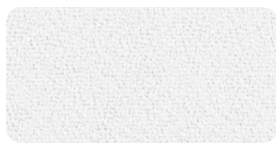

- TP7
Caimi
Bianco Ghiaccio 8002



- TP8
Caimi
Giallo 3008



- TP9
Caimi
Nero 8033