

T-Share

MADE IN ITALY

T-Share Table Meeting/Operative

W 2200 mm x D 1300 mm
x H 740 mm

Top: Fenix

FX1 ○ white Malè

FX2 ● grey Efeso

FX3 ● grey London

Frame: metal

V1 ○ white RAL 9010

V16 ● manganese S051

V16 ● manganese S051

Cable duct: metal

V26 ● black RAL 9005

V25 ● yellow RAL 1006

V25 ● yellow RAL 1006

art.3H2201300 XBBN

art.3H2201300 XGAF

art.3H2201300 XGAC

Top: MDF Perfect Sense

D1 ○ matt white

D2 ● warm grey

D3 ● matt black

Frame: metal

V1 ○ white RAL 9010

V16 ● manganese S051

V26 ● black RAL 9005

Cable duct: metal

V1 ○ white RAL 9010

V25 ● yellow RAL 1006

V26 ● black RAL 9005

art.3H2201300 XM2C

art.3H2201300 XM3A

art.3H2201300 XM3N

Top: melamine

M1 ○ white

M2 ● light grey

MW1 ● maple

Frame: metal

V1 ○ white RAL 9010

V16 ● manganese S051

V26 ● black RAL 9005

Cable duct: metal

V1 ○ white RAL 9010

V25 ● yellow RAL 1006

V26 ● black RAL 9005

art.3H2201300 XM3B

art.3H2201300 XM1G

art.3H2201300 XM1N

DESIGN 967 ARCH

Front

Side

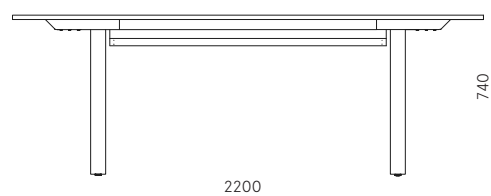
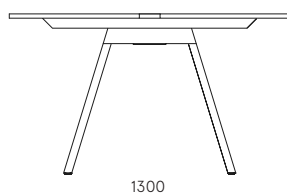
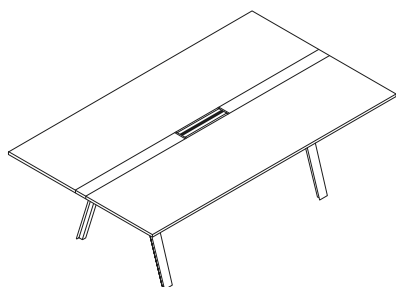

Copyright © dieffebi

Dieffebi SpA

T +39 0438 4715
F +39 0438 471600
exportsales@dieffebi.com
vendite@dieffebi.com
www.dieffebi.com

T-Share

MADE IN ITALY

T-Share Table Meeting/Operative

W 2200 mm x D 1300 mm x H 740 mm

DESIGN 967 ARCH

DESCRIPTION	T-Share Table Meeting/Operative	COLORS	Structure COLORS > Available in 2 standard colors: V1 white (RAL 9010) V16 Manganese Cable duct COLORS > Available in 3 standard colors: V25 Yellow (RAL 1006) V26 Black (RAL 9005) V1 White (RAL 9010) Top COLORS > Fenix available in 3 standard colors: FX1 white (Malè); FX2 grey (Efeso); FX3 grey (London) > MDF Perfect Sense available in 3 standard colors: D1 matt white; D2 warm grey; D3 matt black > Melamine available in 3 standard colors: M1 white; M2 light grey; MW1 maple > Standard semi-gloss colors > Customizable colors available upon request and with an extra charge: www.dieffebi.com/docs/299/2832/DFB_Colour-Chart-2020.pdf
EXTERNAL DIMENSIONS	W 2200 mm x D 1300 mm x H 740 mm		
PRODUCTION	> Dieffebi S.p.a. > Start of production: 2019 > Country of production: Italy		
MATERIALS	> Structure in recycled and recyclable metal > Fenix top: high resistance to scratches and heat, anti-fingerprint, softness to the touch, low light reflection, thermal repairability of micro-scratches, high bacterial reduction activity > PerfectSense MDF top: in Premium Matt, it stands out from other furniture surfaces for its visual and tactile characteristics. The special anti-fingerprint property reduces the formation of fingerprints on the surface and makes cleaning much easier. The trendy design, warm and velvety to the touch, invites you to touch the surface > Melamine: ecological chipboard panel made from recycled wood. The melamine surfaces are resistant and hygienic and do not require any particular maintenance	ACCESSORIES	> Front dividing panel in fabric > Side divider panel in fabric
FINISHING STRUCTURE	> Low-emission powder coating (material inert) > Free from heavy metals > Absence of sharp edges and cutting edges > Anti-glare finish > It does not contain VOCs	NET WEIGHT	94,00 Kg
STANDARD COMPONENTS	> Top Access (1) in painted aluminium with double door and cable retaining bristles > Cable collection channel painted in the same color > Leg cover to cover the power cable passage > Adjustable feet H 10 mm > Assembly screws	MAINTENANCE	> Clean with a soft cloth > Do not treat the surfaces with abrasive cloths
		PACKAGING	> volume: 0,77 m3 > Packed in cardboard box > Supplied disassembled > Packages: 9
		END OF USE	> Equipped with disassembly card for disposal
		WARRANTY	> Dieffebi guarantees that the product was made using high quality materials - See warranty document

T-Share

MADE IN ITALY

T-Share Table Meeting/Operative

W 2200 mm x D 1300 mm x H 740 mm

DESIGN 967ARCH

WELLNESS AND ENVIRONMENT > Green design in accordance with LEED® standards, to design and furnish environments with a high sustainability content



FINISHING TEST UNI EN ISO 2409:2013
METAL NSS UNI EN ISO 9227:2017
STRUCTURE UNI EN 15187:2007EN ISO 1520:2006
 UNI EN ISO 6272-1:2013
 UNI EN 15185:2011
 UNI EN 15186:2012, met.B
 UNI 9300:2015
 EN 12720:2013
 EN 12721:2013
 UNI 9429:2015

CLASS OF > Frame: Class 0
REACTION TO FIRE > Top: Class s1,d0



ADIMEMBER



Dieffebi SpA

via Palù 36
 San Vendemiano,
 31020 Treviso - Italia

T +39 0438 4715
 F +39 0438 471600
 exportsales@dieffebi.com
 vendite@dieffebi.com
 www.dieffebi.com

T-Share

Varnish
Vernici
Vernis
Lacke

Frame
Struttura
Piètement
Gestell



-V1
S711 (RAL 9010)
Pure white



-V16
S051
Manganese



-V26
S885 (RAL 9005)
Black opaco

Cable duct
Canalina
Goulotte pour
câblage
Kabelwanne



-V4
S708 (RAL 9010)
Pure white textured finish



-V25
S107 (RAL 1006)
Yellow



-V26
S885 (RAL 9005)
Black opaco

Fenix

Top
Piano
Plateau
Tischplatte

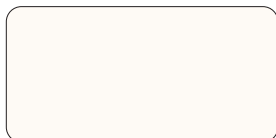

-FX1
Bianco/White /Blanc/Weiß – Malè



-FX2
Grigio/Grey/Gris/Grau – Efeso



-FX3
Grigio/Grey/Gris/Grau – London

MDF Perfect Sense

Top
Piano
Plateau
Tischplatte



-D1
Bianco opaco/Matt White
/Blanc mat/Matt weiß



-D2
Grigio caldo/Warm grey
/Gris chaud/Warmes Grau



-D3
Nero opaco/Matt black
/Noir mat/Mattschwarz

T-Share

Melamine
Melaminico
Mélaminé
Melamin

Top
Piano
Plateau
Tischplatte

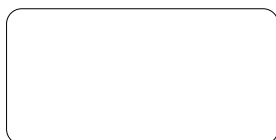

-M1
Bianco/White/Blanc/Weiß



-M2
Grigio chiaro/Light grey
/Gris clair/Hellgrau



-MW1
Acero/Maple/Érable/Ahorn

Tessuti
Fabrics
Tissus
Textilien

Fabric acoustic panel
complete
with magnetic support
Pannello acustico
completo
di supporto magnetico
Panneau acoustique
avec support magnétique
Stoffbezogene
Akustikplatte mit
magnetischer
Unterstützung



- TP7
Caimi
White 8002



- TP8
Caimi
Yellow 3008



- TP9
Caimi
Black 8033

T-Share

MADE IN ITALY

T-Share Table Meeting

W 2400 mm x D 1300 mm
x H 740 mm

Top: Fenix
FX1 ○ white Malè
FX2 ● grey Efeso
FX3 ● grey London

Frame: metal
V1 ○ white RAL 9010
V16 ● manganese S051
V16 ● manganese S051

Cable duct: metal
V26 ● black RAL 9005
V25 ● yellow RAL 1006
V25 ● yellow RAL 1006

art.3H2401300 XBBN
art.3H2401300 XGAF
art.3H2401300 XGAC

Top: MDF Perfect Sense
D1 ○ matt white
D2 ● warm grey
D3 ● matt black

Frame: metal
V1 ○ white RAL 9010
V16 ● manganese S051
V26 ● black RAL 9005

Cable duct: metal
V1 ○ white RAL 9010
V25 ● yellow RAL 1006
V26 ● black RAL 9005

art.3H2401300 XM2C
art.3H2401300 XM3A
art.3H2401300 XM3N

Top: melamine
M1 ○ white
M2 ● light grey
MW1 ● maple

Frame: metal
V1 ○ white RAL 9010
V16 ● manganese S051
V26 ● black RAL 9005

Cable duct: metal
V1 ○ white RAL 9010
V25 ● yellow RAL 1006
V26 ● black RAL 9005

art.3H2401300 XM3B
art.3H2401300 XM1G
art.3H2401300 XM1N

DESIGN 967 ARCH

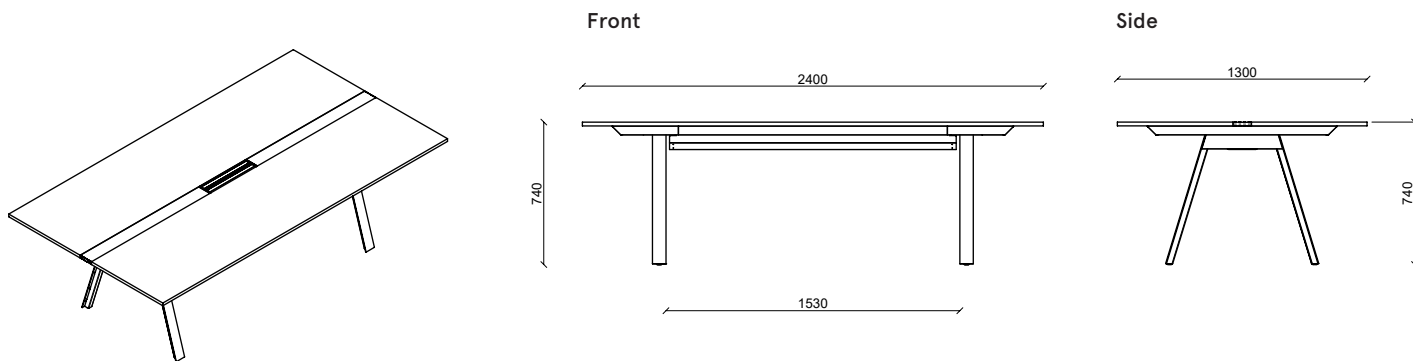

Copyright © dieffebi

T-Share

MADE IN ITALY

T-Share Table Meeting

W 2400 mm x D 1300 mm x H 740 mm

DESIGN 967 ARCH

DESCRIPTION	T-Share Table Meeting	COLORS	Structure COLORS > Available in 2 standard colors: V1 white (RAL 9010) V16 Manganese Cable duct COLORS > Available in 3 standard colors: V25 Yellow (RAL 1006) V26 Black (RAL 9005) V1 White (RAL 9010) Top COLORS > Fenix available in 3 standard colors: FX1 white (Malè); FX2 grey (Efeso); FX3 grey (London) > MDF Perfect Sense available in 3 standard colors: D1 matt white; D2 warm grey; D3 matt black > Melamine available in 3 standard colors: M1 white; M2 light grey; MW1 maple > Standard semi-gloss colors > Customizable colors available upon request and with an extra charge: www.dieffebi.com/docs/299/2832/DFB_Colour-Chart-2020.pdf
EXTERNAL DIMENSIONS	W 2400 mm x D 1300 mm x H 740 mm	ACCESSORIES	> Front dividing panel in fabric > Side divider panel in fabric
PRODUCTION	> Dieffebi S.p.a. > Start of production: 2019 > Country of production: Italy	NET WEIGHT	103,00 Kg
MATERIALS	> Structure in recycled and recyclable metal > Fenix top: high resistance to scratches and heat, anti-fingerprint, softness to the touch, low light reflection, thermal repairability of micro-scratches, high bacterial reduction activity > PerfectSense MDF top: in Premium Matt, it stands out from other furniture surfaces for its visual and tactile characteristics. The special anti-fingerprint property reduces the formation of fingerprints on the surface and makes cleaning much easier. The trendy design, warm and velvety to the touch, invites you to touch the surface > Melamine: ecological chipboard panel made from recycled wood. The melamine surfaces are resistant and hygienic and do not require any particular maintenance	MAINTENANCE	> Clean with a soft cloth > Do not treat the surfaces with abrasive cloths
FINISHING STRUCTURE	> Low-emission powder coating (material inert) > Free from heavy metals > Absence of sharp edges and cutting edges > Anti-glare finish > It does not contain VOCs	PACKAGING	> volume: 0,79 m3 > Packed in cardboard box > Supplied disassembled > Packages: 9
STANDARD COMPONENTS	> Top Access (1) in painted aluminium with double door and cable retaining bristles > Cable collection channel painted in the same color > Leg cover to cover the power cable passage > Adjustable feet H 10 mm > Assembly screws	END OF USE	> Equipped with disassembly card for disposal
		WARRANTY	> Dieffebi guarantees that the product was made using high quality materials - See warranty document

T-Share

MADE IN ITALY

T-Share Table Meeting

W 2400 mm x D 1300 mm x H 740 mm

DESIGN 967ARCH

WELLNESS AND ENVIRONMENT > Green design in accordance with LEED® standards, to design and furnish environments with a high sustainability content



FINISHING TEST	UNI EN ISO 2409:2013
METAL	NSS UNI EN ISO 9227:2017
STRUCTURE	UNI EN 15187:2007EN ISO 1520:2006 UNI EN ISO 6272-1:2013 UNI EN 15185:2011 UNI EN 15186:2012, met.B UNI 9300:2015 EN 12720:2013 EN 12721:2013 UNI 9429:2015

CLASS OF	> Frame: Class 0
REACTION TO FIRE	> Top: Class s1,d0



ADIMEMBER



T-Share

Varnish
Vernici
Vernis
Lacke

Frame
Struttura
Piètement
Gestell



-V1
S711 (RAL 9010)
Pure white



-V16
S051
Manganese



-V26
S885 (RAL 9005)
Black opaco

Cable duct
Canalina
Goulotte pour
câblage
Kabelwanne



-V4
S708 (RAL 9010)
Pure white textured finish



-V25
S107 (RAL 1006)
Yellow



-V26
S885 (RAL 9005)
Black opaco

Fenix

Top
Piano
Plateau
Tischplatte

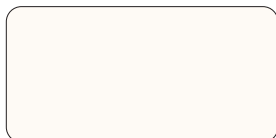

-FX1
Bianco/White /Blanc/Weiß – Malè



-FX2
Grigio/Grey/Gris/Grau – Efeso



-FX3
Grigio/Grey/Gris/Grau – London

MDF Perfect Sense

Top
Piano
Plateau
Tischplatte



-D1
Bianco opaco/Matt White
/Blanc mat/Matt weiß



-D2
Grigio caldo/Warm grey
/Gris chaud/Warmes Grau



-D3
Nero opaco/Matt black
/Noir mat/Mattschwarz

T-Share

Melaminico
Melamine
Mélaminé
Melamin

Piano
Top
Plateau
Tischplatte



-M1
Bianco/White/Blanc/Weiß



-M2
Grigio chiaro/Light grey
/Gris clair/Hellgrau



-MW1
Acero/Maple/Érable/Ahorn

Tessuti
Fabrics
Tissus
Textilien

Pannello acustico
completo
di supporto magnetico
Fabric acoustic panel
complete
with magnetic support
Panneau acoustique
avec support magnétique
Stoffbezogene
Akustikplatte mit
magnetischer
Unterstützung



- TP7
Caimi
White 8002



- TP8
Caimi
Yellow 3008



- TP9
Caimi
Black 8033

T-Share

MADE IN ITALY

T-Share Table Operative

W 2400 mm x D 1300 mm
x H 740 mm

Top: Fenix

FX1 ○ white Malè
FX2 ● grey Efeso
FX3 ● grey London

Frame: metal

V1 ○ white RAL 9010
V16 ● manganese S051
V16 ● manganese S051

Cable duct: metal

V26 ● black RAL 9005
V25 ● yellow RAL 1006
V25 ● yellow RAL 1006art.3H24S1300 XBBN
art.3H24S1300 XGAF
art.3H24S1300 XGAC

Top: MDF Perfect Sense

D1 ○ matt white
D2 ● warm grey
D3 ● matt black

Frame: metal

V1 ○ white RAL 9010
V16 ● manganese S051
V26 ● black RAL 9005

Cable duct: metal

V1 ○ white RAL 9010
V25 ● yellow RAL 1006
V26 ● black RAL 9005art.3H24S1300 XM2C
art.3H24S1300 XM3A
art.3H24S1300 XM3N

Top: melamine

M1 ○ white
M2 ● light grey
MW1 ● maple

Frame: metal

V1 ○ white RAL 9010
V16 ● manganese S051
V26 ● black RAL 9005

Cable duct: metal

V1 ○ white RAL 9010
V25 ● yellow RAL 1006
V26 ● black RAL 9005art.3H24S1300 XM3B
art.3H24S1300 XM1G
art.3H24S1300 XM1N

DESIGN 967 ARCH

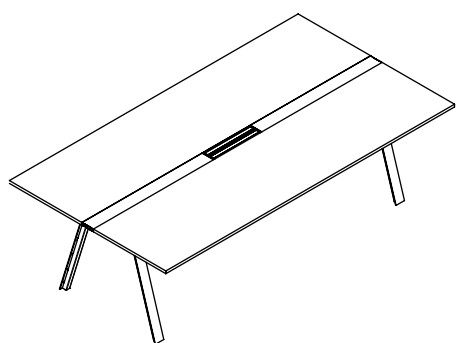

Front



Side

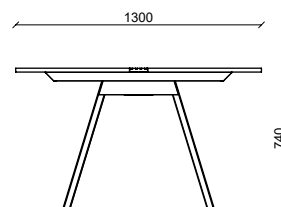

Copyright © dieffebi

T-Share

MADE IN ITALY

T-Share Table Operative

W 2400 mm x D 1300 mm x H 740 mm

DESIGN 967 ARCH

DESCRIPTION	T-Share Table Operative	COLORS	Structure COLORS > Available in 2 standard colors: V1 white (RAL 9010) V16 Manganese Cable duct COLORS > Available in 3 standard colors: V25 Yellow (RAL 1006) V26 Black (RAL 9005) V1 White (RAL 9010) Top COLORS > Fenix available in 3 standard colors: FX1 white (Malè); FX2 grey (Efeso); FX3 grey (London) > MDF Perfect Sense available in 3 standard colors: D1 matt white; D2 warm grey; D3 matt black > Melamine available in 3 standard colors: M1 white; M2 light grey; MW1 maple > Standard semi-gloss colors > Customizable colors available upon request and with an extra charge: www.dieffebi.com/docs/299/2832/DFB_Colour-Chart-2020.pdf
EXTERNAL DIMENSIONS	W 2400 mm x D 1300 mm x H 740 mm		
PRODUCTION	> Dieffebi S.p.a. > Start of production: 2019 > Country of production: Italy		
MATERIALS	> Structure in recycled and recyclable metal > Fenix top: high resistance to scratches and heat, anti-fingerprint, softness to the touch, low light reflection, thermal reparability of micro-scratches, high bacterial reduction activity > PerfectSense MDF top: in Premium Matt, it stands out from other furniture surfaces for its visual and tactile characteristics. The special anti-fingerprint property reduces the formation of fingerprints on the surface and makes cleaning much easier. The trendy design, warm and velvety to the touch, invites you to touch the surface > Melamine: ecological chipboard panel made from recycled wood. The melamine surfaces are resistant and hygienic and do not require any particular maintenance	ACCESSORIES	> Front dividing panel in fabric > Side divider panel in fabric
FINISHING STRUCTURE	> Low-emission powder coating (material inert) > Free from heavy metals > Absence of sharp edges and cutting edges > Anti-glare finish > It does not contain VOCs	NET WEIGHT	105,00 Kg
STANDARD COMPONENTS	> Top Access (1) in painted aluminium with double door and cable retaining bristles > Cable collection channel painted in the same color > Leg cover to cover the power cable passage > Adjustable feet H 10 mm > Assembly screws	MAINTENANCE	> Clean with a soft cloth > Do not treat the surfaces with abrasive cloths
		PACKAGING	> volume: 0,79 m3 > Packed in cardboard box > Supplied disassembled > Packages: 8
		END OF USE	> Equipped with disassembly card for disposal
		WARRANTY	> Dieffebi guarantees that the product was made using high quality materials - See warranty document

T-Share

MADE IN ITALY

T-Share Table Operative

W 2400 mm x D 1300 mm x H 740 mm

DESIGN 967ARCH

WELLNESS AND ENVIRONMENT > Green design in accordance with LEED® standards, to design and furnish environments with a high sustainability content



FINISHING TEST	UNI EN ISO 2409:2013
METAL	NSS UNI EN ISO 9227:2017
STRUCTURE	UNI EN 15187:2007EN ISO 1520:2006 UNI EN ISO 6272-1:2013 UNI EN 15185:2011 UNI EN 15186:2012, met.B UNI 9300:2015 EN 12720:2013 EN 12721:2013 UNI 9429:2015

CLASS OF > Frame: Class 0
REACTION TO FIRE > Top: Class s1,d0



ADIMEMBER



T-Share

Varnish
Vernici
Vernis
Lacke

Frame
Struttura
Piètement
Gestell



-V1
S711 (RAL 9010)
Pure white



-V16
S051
Manganese



-V26
S885 (RAL 9005)
Black opaco

Cable duct
Canalina
Goulotte pour
câblage
Kabelwanne



-V4
S708 (RAL 9010)
Pure white textured finish



-V25
S107 (RAL 1006)
Yellow



-V26
S885 (RAL 9005)
Black opaco

Fenix

Top
Piano
Plateau
Tischplatte

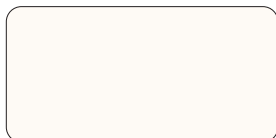

-FX1
Bianco/White /Blanc/Weiß – Malè



-FX2
Grigio/Grey/Gris/Grau – Efeso



-FX3
Grigio/Grey/Gris/Grau – London

MDF Perfect Sense

Top
Piano
Plateau
Tischplatte



-D1
Bianco opaco/Matt White
/Blanc mat/Matt weiß



-D2
Grigio caldo/Warm grey
/Gris chaud/Warmes Grau



-D3
Nero opaco/Matt black
/Noir mat/Mattschwarz

T-Share

Melamine
Melaminico
Mélaminé
Melamin

Top
Piano
Plateau
Tischplatte

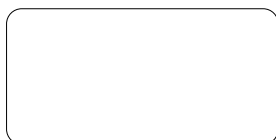

-M1
Bianco/White/Blanc/Weiß



-M2
Grigio chiaro/Light grey
/Gris clair/Hellgrau



-MW1
Acero/Maple/Érable/Ahorn

Fabrics
Tessuti
Tissus
Textilien

Fabric acoustic panel
complete
with magnetic support
Pannello acustico
completo
di supporto magnetico
Panneau acoustique
avec support magnétique
Stoffbezogene
Akustikplatte mit
magnetischer
Unterstützung



- TP7
Caimi
White 8002



- TP8
Caimi
Yellow 3008



- TP9
Caimi
Black 8033

T-Share

MADE IN ITALY

T-Share Table Meeting

W 2780 mm x D1300 mm
x H 740 mm

Top: Fenix

FX1 ○ white Malè

FX2 ● grey Efeso

FX3 ● grey London

Frame: metal

V1 ○ white RAL 9010

V16 ● manganese S051

V16 ● manganese S051

Cable duct: metal

V26 ● black RAL 9005

V25 ● yellow RAL 1006

V25 ● yellow RAL 1006

art.3H2801300 XBBN

art.3H2801300 XGAF

art.3H2801300 XGAC

Top: MDF Perfect Sense

D1 ○ matt white

D2 ● warm grey

D3 ● matt black

Frame: metal

V1 ○ white RAL 9010

V16 ● manganese S051

V26 ● black RAL 9005

Cable duct: metal

V1 ○ white RAL 9010

V25 ● yellow RAL 1006

V26 ● black RAL 9005

art.3H2801300 XM2C

art.3H2801300 XM3A

art.3H2801300 XM3N

Top: melamine

M1 ○ white

M2 ● light grey

MW1 ● maple

Frame: metal

V1 ○ white RAL 9010

V16 ● manganese S051

V26 ● black RAL 9005

Cable duct: metal

V1 ○ white RAL 9010

V25 ● yellow RAL 1006

V26 ● black RAL 9005

art.3H2801300 XM3B

art.3H2801300 XM1G

art.3H2801300 XM1N

DESIGN 967 ARCH

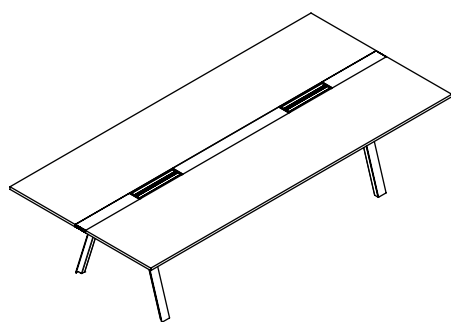

Front

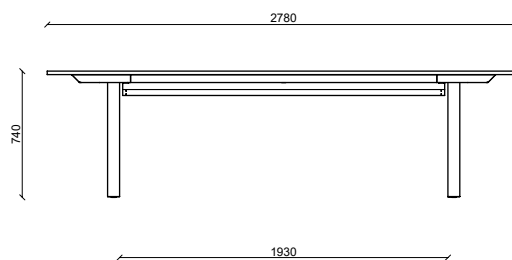

Side

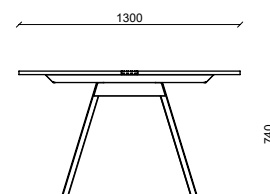

T-Share

MADE IN ITALY

T-Share Table Meeting

W 2780 mm x D1300 mm x H 740 mm

DESIGN 967 ARCH

DESCRIPTION	T-Share Table Meeting	COLORS	Structure COLORS > Available in 2 standard colors: V1 white (RAL 9010) V16 Manganese Cable duct COLORS > Available in 3 standard colors: V25 Yellow (RAL 1006) V26 Black (RAL 9005) V1 White (RAL 9010) Top COLORS > Fenix available in 3 standard colors: FX1 white (Malè); FX2 grey (Efeso); FX3 grey (London) > MDF Perfect Sense available in 3 standard colors: D1 matt white; D2 warm grey; D3 matt black > Melamine available in 3 standard colors: M1 white; M2 light grey; MW1 maple > Standard semi-gloss colors > Customizable colors available upon request and with an extra charge: www.dieffebi.com/docs/299/2832/DFB_Colour-Chart-2020.pdf
EXTERNAL DIMENSIONS	W 2780 mm x D 1300 mm x H 740 mm	ACCESSORIES	> Front dividing panel in fabric > Side divider panel in fabric
PRODUCTION	> Dieffebi S.p.a. > Start of production: 2019 > Country of production: Italy	NET WEIGHT	120,00 Kg
MATERIALS	> Structure in recycled and recyclable metal > Fenix top: high resistance to scratches and heat, anti-fingerprint, softness to the touch, low light reflection, thermal repairability of micro-scratches, high bacterial reduction activity > PerfectSense MDF top: in Premium Matt, it stands out from other furniture surfaces for its visual and tactile characteristics. The special anti-fingerprint property reduces the formation of fingerprints on the surface and makes cleaning much easier. The trendy design, warm and velvety to the touch, invites you to touch the surface > Melamine: ecological chipboard panel made from recycled wood. The melamine surfaces are resistant and hygienic and do not require any particular maintenance	MAINTENANCE	> Clean with a soft cloth > Do not treat the surfaces with abrasive cloths
FINISHING STRUCTURE	> Low-emission powder coating (material inert) > Free from heavy metals > Absence of sharp edges and cutting edges > Anti-glare finish > It does not contain VOCs	PACKAGING	> volume: 0,85 m ³ > Packed in cardboard box > Supplied disassembled > Packages: 9
STANDARD COMPONENTS	> Top Access (2) in painted aluminium with double door and cable retaining bristles > Cable collection channel painted in the same color > Leg cover to cover the power cable passage > Adjustable feet H 10 mm > Assembly screws	END OF USE	> Equipped with disassembly card for disposal
		WARRANTY	> Dieffebi guarantees that the product was made using high quality materials - See warranty document

T-Share

MADE IN ITALY

T-Share Table Meeting

W 2780 mm x D1300 mm x H 740 mm

DESIGN 967ARCH

WELLNESS AND ENVIRONMENT > Green design in accordance with LEED® standards, to design and furnish environments with a high sustainability content



FINISHING TEST	UNI EN ISO 2409:2013
METAL	NSS UNI EN ISO 9227:2017
STRUCTURE	UNI EN 15187:2007EN ISO 1520:2006 UNI EN ISO 6272-1:2013 UNI EN 15185:2011 UNI EN 15186:2012, met.B UNI 9300:2015 EN 12720:2013 EN 12721:2013 UNI 9429:2015

CLASS OF > Frame: Class 0
REACTION TO FIRE > Top: Class s1,d0



ADIMEMBER



T-Share

Varnish
Vernici
Vernis
Lacke

Frame
Struttura
Piètement
Gestell



-V1
S711 (RAL 9010)
Pure white



-V16
S051
Manganese



-V26
S885 (RAL 9005)
Black opaco

Cable duct
Canalina
Goulotte pour
câblage
Kabelwanne



-V4
S708 (RAL 9010)
Pure white textured finish



-V25
S107 (RAL 1006)
Yellow



-V26
S885 (RAL 9005)
Black opaco

Fenix

Top
Piano
Plateau
Tischplatte

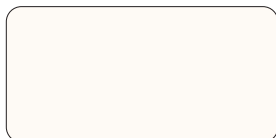

-FX1
Bianco/White /Blanc/Weiß – Malè



-FX2
Grigio/Grey/Gris/Grau – Efeso



-FX3
Grigio/Grey/Gris/Grau – London

MDF Perfect Sense

Top
Piano
Plateau
Tischplatte



-D1
Bianco opaco/Matt White
/Blanc mat/Matt weiß



-D2
Grigio caldo/Warm grey
/Gris chaud/Warmes Grau



-D3
Nero opaco/Matt black
/Noir mat/Mattschwarz

T-Share

Melamine
Melaminico
Mélaminé
Melamin

Top
Piano
Plateau
Tischplatte

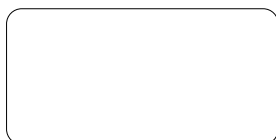

-M1
Bianco/White/Blanc/Weiß



-M2
Grigio chiaro/Light grey
/Gris clair/Hellgrau



-MW1
Acero/Maple/Érable/Ahorn

Fabrics
Tessuti
Tissus
Textilien

Fabric acoustic panel
complete
with magnetic support
Pannello acustico
completo
di supporto magnetico
Panneau acoustique
avec support magnétique
Stoffbezogene
Akustikplatte mit
magnetischer
Unterstützung



- TP7
Caimi
White 8002



- TP8
Caimi
Yellow 3008



- TP9
Caimi
Black 8033

T-Share

MADE IN ITALY

T-Share Table Meeting

W 2000 mm x D 900 mm
x H 740 mm

Top: Fenix

FX1 ○ white Malè
FX2 ● grey Efeso
FX3 ● grey London

Frame: metal

V1 ○ white RAL 9010
V16 ● manganese S051
V16 ● manganese S051

Cable duct: metal

V26 ● black RAL 9005
V25 ● yellow RAL 1006
V25 ● yellow RAL 1006art.3H2000900 XBBN
art.3H2000900 XGAF
art.3H2000900 XGAC

Top: MDF Perfect Sense

D1 ○ matt white
D2 ● warm grey
D3 ● matt black

Frame: metal

V1 ○ white RAL 9010
V16 ● manganese S051
V26 ● black RAL 9005

Cable duct: metal

V1 ○ white RAL 9010
V25 ● yellow RAL 1006
V26 ● black RAL 9005art.3H2000900 XM2C
art.3H2000900 XM3A
art.3H2000900 XM3N

Top: melamine

M1 ○ white
M2 ● light grey
MW1 ● maple

Frame: metal

V1 ○ white RAL 9010
V16 ● manganese S051
V26 ● black RAL 9005

Cable duct: metal

V1 ○ white RAL 9010
V25 ● yellow RAL 1006
V26 ● black RAL 9005art.3H2000900 XM3B
art.3H2000900 XM1G
art.3H2000900 XM1N

DESIGN 967 ARCH

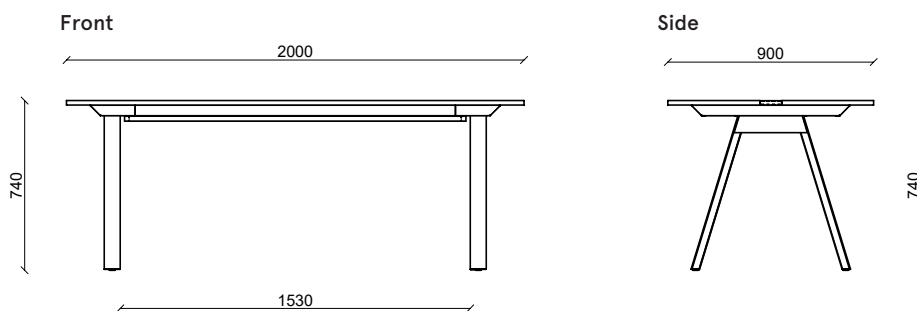
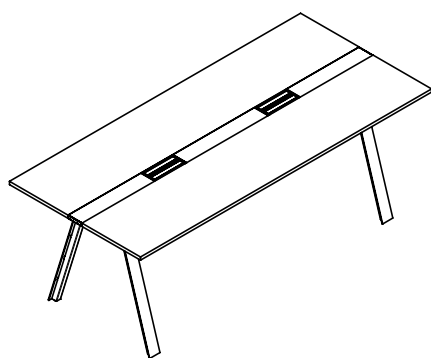

T-Share

MADE IN ITALY

T-Share Table Meeting

W 2000 mm x D 900 mm x H 740 mm

DESIGN 967 ARCH

DESCRIPTION	T-Share Table Meeting	COLORS	Structure COLORS > Available in 2 standard colors: V1 white (RAL 9010) V16 Manganese Cable duct COLORS > Available in 3 standard colors: V25 Yellow (RAL 1006) V26 Black (RAL 9005) V1 White (RAL 9010) Top COLORS > Fenix available in 3 standard colors: FX1 white (Malè); FX2 grey (Efeso); FX3 grey (London) > MDF Perfect Sense available in 3 standard colors: D1 matt white; D2 warm grey; D3 matt black > Melamine available in 3 standard colors: M1 white; M2 light grey; MW1 maple > Standard semi-gloss colors > Customizable colors available upon request and with an extra charge: www.dieffebi.com/docs/299/2832/DFB_Colour-Chart-2020.pdf
EXTERNAL DIMENSIONS	W 2000 mm x D 900 mm x H 740 mm		
PRODUCTION	> Dieffebi S.p.a. > Start of production: 2019 > Country of production: Italy		
MATERIALS	> Structure in recycled and recyclable metal > Fenix top: high resistance to scratches and heat, anti-fingerprint, softness to the touch, low light reflection, thermal repairability of micro-scratches, high bacterial reduction activity > PerfectSense MDF top: in Premium Matt, it stands out from other furniture surfaces for its visual and tactile characteristics. The special anti-fingerprint property reduces the formation of fingerprints on the surface and makes cleaning much easier. The trendy design, warm and velvety to the touch, invites you to touch the surface > Melamine: ecological chipboard panel made from recycled wood. The melamine surfaces are resistant and hygienic and do not require any particular maintenance	ACCESSORIES	> Front dividing panel in fabric > Side divider panel in fabric
FINISHING STRUCTURE	> Low-emission powder coating (material inert) > Free from heavy metals > Absence of sharp edges and cutting edges > Anti-glare finish > It does not contain VOCs	NET WEIGHT	69,00 Kg
STANDARD COMPONENTS	> Top Access (2) in painted aluminium with double door and cable retaining bristles > Cable collection channel painted in the same color > Leg cover to cover the power cable passage > Adjustable feet H 10 mm > Assembly screws	MAINTENANCE	> Clean with a soft cloth > Do not treat the surfaces with abrasive cloths
		PACKAGING	> volume: 0,60 m ³ > Packed in cardboard box > Supplied disassembled > Packages: 7
		END OF USE	> Equipped with disassembly card for disposal
		WARRANTY	> Dieffebi guarantees that the product was made using high quality materials - See warranty document

T-Share

MADE IN ITALY

T-Share Table Meeting

W 2000 mm x D 900 mm x H 740 mm

DESIGN 967ARCH

WELLNESS AND ENVIRONMENT > Green design in accordance with LEED® standards, to design and furnish environments with a high sustainability content



FINISHING TEST UNI EN ISO 2409:2013
METAL NSS UNI EN ISO 9227:2017
STRUCTURE UNI EN 15187:2007EN ISO 1520:2006
 UNI EN ISO 6272-1:2013
 UNI EN 15185:2011
 UNI EN 15186:2012, met.B
 UNI 9300:2015
 EN 12720:2013
 EN 12721:2013
 UNI 9429:2015

CLASS OF > Frame: Class 0
REACTION TO FIRE > Top: Class s1,d0



ADIMEMBER



T-Share

Varnish
Vernici
Vernis
Lacke

Frame
Struttura
Piètement
Gestell



-V1
S711 (RAL 9010)
Pure white



-V16
S051
Manganese



-V26
S885 (RAL 9005)
Black opaco

Cable duct
Canalina
Goulotte pour
câblage
Kabelwanne



-V4
S708 (RAL 9010)
Pure white textured finish



-V25
S107 (RAL 1006)
Yellow



-V26
S885 (RAL 9005)
Black opaco

Fenix

Top
Piano
Plateau
Tischplatte

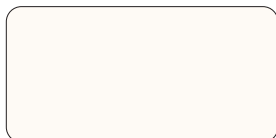

-FX1
Bianco/White /Blanc/Weiß – Malè



-FX2
Grigio/Grey/Gris/Grau – Efeso



-FX3
Grigio/Grey/Gris/Grau – London

MDF Perfect Sense

Top
Piano
Plateau
Tischplatte



-D1
Bianco opaco/Matt White
/Blanc mat/Matt weiß



-D2
Grigio caldo/Warm grey
/Gris chaud/Warmes Grau



-D3
Nero opaco/Matt black
/Noir mat/Mattschwarz

T-Share

Melamine
Melaminico
Mélaminé
Melamin

Top
Piano
Plateau
Tischplatte



-M1
Bianco/White/Blanc/Weiß



-M2
Grigio chiaro/Light grey
/Gris clair/Hellgrau



-MW1
Acero/Maple/Érable/Ahorn

Fabrics
Tessuti
Tissus
Textilien

Fabric acoustic panel
complete
with magnetic support
Pannello acustico
completo
di supporto magnetico
Panneau acoustique
avec support magnétique
Stoffbezogene
Akustikplatte mit
magnetischer
Unterstützung



- TP7
Caimi
White 8002



- TP8
Caimi
Yellow 3008



- TP9
Caimi
Black 8033

T-Share

MADE IN ITALY

T-Share Table Meeting

W 2400 mm x D 900 mm
x H 740 mm

Top: Fenix

FX1 ○ white Malè

FX2 ● grey Efeso

FX3 ● grey London

Frame: metal

V1 ○ white RAL 9010

V16 ● manganese S051

V16 ● manganese S051

Cable duct: metal

V26 ● black RAL 9005

V25 ● yellow RAL 1006

V25 ● yellow RAL 1006

art.3H2400900 XBBN

art.3H2400900 XGAF

art.3H2400900 XGAC

Top: MDF Perfect Sense

D1 ○ matt white

D2 ● warm grey

D3 ● matt black

Frame: metal

V1 ○ white RAL 9010

V16 ● manganese S051

V26 ● black RAL 9005

Cable duct: metal

V1 ○ white RAL 9010

V25 ● yellow RAL 1006

V26 ● black RAL 9005

art.3H2400900 XM2C

art.3H2400900 XM3A

art.3H2400900 XM3N

Top: melamine

M1 ○ white

M2 ● light grey

MW1 ● maple

Frame: metal

V1 ○ white RAL 9010

V16 ● manganese S051

V26 ● black RAL 9005

Cable duct: metal

V1 ○ white RAL 9010

V25 ● yellow RAL 1006

V26 ● black RAL 9005

art.3H2400900 XM3B

art.3H2400900 XM1G

art.3H2400900 XM1N

DESIGN 967 ARCH

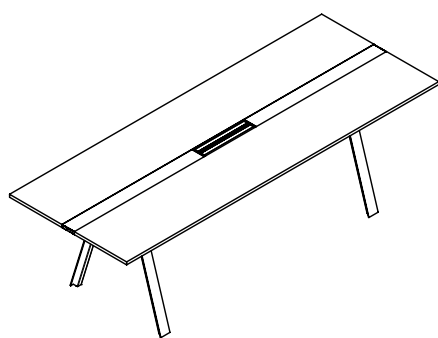

Front

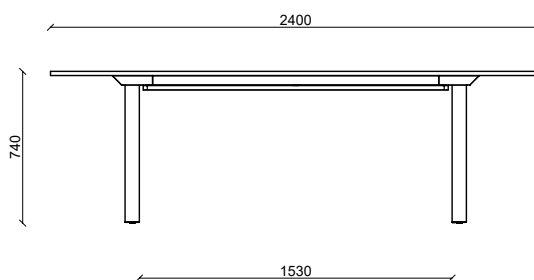

Side

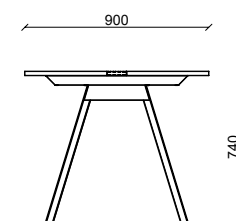

T-Share

MADE IN ITALY

T-Share Table Meeting

W 2400 mm x D 900 mm x H 740 mm

DESIGN 967 ARCH

DESCRIPTION	T-Share Table Meeting	COLORS	Structure COLORS > Available in 2 standard colors: V1 white (RAL 9010) V16 Manganese Cable duct COLORS > Available in 3 standard colors: V25 Yellow (RAL 1006) V26 Black (RAL 9005) V1 White (RAL 9010) Top COLORS > Fenix available in 3 standard colors: FX1 white (Malè); FX2 grey (Efeso); FX3 grey (London) > MDF Perfect Sense available in 3 standard colors: D1 matt white; D2 warm grey; D3 matt black > Melamine available in 3 standard colors: M1 white; M2 light grey; MW1 maple > Standard semi-gloss colors > Customizable colors available upon request and with an extra charge: www.dieffebi.com/docs/299/2832/DFB_Colour-Chart-2020.pdf
EXTERNAL DIMENSIONS	W 2400 mm x D 900 mm x H 740 mm	ACCESSORIES	> Front dividing panel in fabric > Side divider panel in fabric
PRODUCTION	> Dieffebi S.p.a. > Start of production: 2019 > Country of production: Italy	NET WEIGHT	74,00 Kg
MATERIALS	> Structure in recycled and recyclable metal > Fenix top: high resistance to scratches and heat, anti-fingerprint, softness to the touch, low light reflection, thermal repairability of micro-scratches, high bacterial reduction activity > PerfectSense MDF top: in Premium Matt, it stands out from other furniture surfaces for its visual and tactile characteristics. The special anti-fingerprint property reduces the formation of fingerprints on the surface and makes cleaning much easier. The trendy design, warm and velvety to the touch, invites you to touch the surface >Melamine: ecological chipboard panel made from recycled wood. The melamine surfaces are resistant and hygienic and do not require any particular maintenance	MAINTENANCE	> Clean with a soft cloth > Do not treat the surfaces with abrasive cloths
FINISHING STRUCTURE	>Low-emission powder coating (material inert) >Free from heavy metals >Absence of sharp edges and cutting edges >Anti-glare finish >It does not contain VOCs	PACKAGING	> volume: 0,62 m ³ > Packed in cardboard box > Supplied disassembled > Packages: 7
STANDARD COMPONENTS	> Top Access (1) in painted aluminium with double door and cable retaining bristles > Cable collection channel painted in the same color > Leg cover to cover the power cable passage > Adjustable feet H 10 mm > Assembly screws	END OF USE	> Equipped with disassembly card for disposal
		WARRANTY	> Dieffebi guarantees that the product was made using high quality materials - See warranty document

T-Share

MADE IN ITALY

T-Share Table Meeting

W 2400 mm x D 900 mm x H 740 mm

DESIGN 967ARCH

WELLNESS AND ENVIRONMENT > Green design in accordance with LEED® standards, to design and furnish environments with a high sustainability content



www.GreenTop.com



FINISHING TEST UNI EN ISO 2409:2013
METAL NSS UNI EN ISO 9227:2017
STRUCTURE UNI EN 15187:2007EN ISO 1520:2006
 UNI EN ISO 6272-1:2013
 UNI EN 15185:2011
 UNI EN 15186:2012, met.B
 UNI 9300:2015
 EN 12720:2013
 EN 12721:2013
 UNI 9429:2015

CLASS OF > Frame: Class 0
REACTION TO FIRE > Top: Class s1,d0



dieffebi



MADE IN EUROPE

ASSUFFICIO
ASSOCIAZIONE FIDELIENEGARRECO

ADIMEMBER



consip
 acquistinretepa.it
Il Fornitore Aggiunto della Pubblica Amministrazione

T-Share

Varnish
Vernici
Vernis
Lacke

Frame
Struttura
Piètement
Gestell



-V1
S711 (RAL 9010)
Pure white



-V16
S051
Manganese



-V26
S885 (RAL 9005)
Black opaco

Cable duct
Canalina
Goulotte pour
câblage
Kabelwanne



-V4
S708 (RAL 9010)
Pure white textured finish



-V25
S107 (RAL 1006)
Yellow



-V26
S885 (RAL 9005)
Black opaco

Fenix

Top
Piano
Plateau
Tischplatte

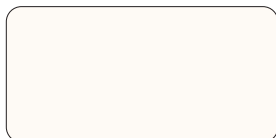

-FX1
Bianco/White /Blanc/Weiß – Malè



-FX2
Grigio/Grey/Gris/Grau – Efeso



-FX3
Grigio/Grey/Gris/Grau – London

MDF Perfect Sense

Top Piano
Plateau
Tischplatte



-D1
Bianco opaco/Matt White
/Blanc mat/Matt weiß



-D2
Grigio caldo/Warm grey
/Gris chaud/Warmes Grau



-D3
Nero opaco/Matt black
/Noir mat/Mattschwarz

T-Share

Melaminico
Melamine
Mélaminé
Melamin

Piano
Top
Plateau
Tischplatte



-M1
Bianco/White/Blanc/Weiß



-M2
Grigio chiaro/Light grey
/Gris clair/Hellgrau



-MW1
Acero/Maple/Érable/Ahorn

Tessuti
Fabrics
Tissus
Textilien

Pannello acustico
completo
di supporto magnetico
Fabric acoustic panel
complete
with magnetic support
Panneau acoustique
avec support magnétique
Stoffbezogene
Akustikplatte mit
magnetischer
Unterstützung



- TP7
Caimi
Bianco Ghiaccio 8002



- TP8
Caimi
Giallo 3008



- TP9
Caimi
Nero 8033

T-Share

MADE IN ITALY

T-Share Table Meeting

W 2000 mm x D 900 mm
x H 1050 mm

Top: Fenix

FX1 ○ white Malè

FX2 ● grey Efeso

FX3 ● grey London

Frame: metal

V1 ○ white RAL 9010

V16 ● manganese S051

V16 ● manganese S051

Cable duct: metal

V26 ● black RAL 9005

V25 ● yellow RAL 1006

V25 ● yellow RAL 1006

art.3H200H900 XBBN

art.3H200H900 XGAF

art.3H200H900 XGAC

Top: MDF Perfect Sense

D1 ○ matt white

D2 ● warm grey

D3 ● matt black

Frame: metal

V1 ○ white RAL 9010

V16 ● manganese S051

V26 ● black RAL 9005

Cable duct: metal

V1 ○ white RAL 9010

V25 ● yellow RAL 1006

V26 ● black RAL 9005

art.3H200H900 XM2C

art.3H200H900 XM3A

art.3H200H900 XM3N

Top: melamine

M1 ○ white

M2 ● light grey

MW1 ● maple

Frame: metal

V1 ○ white RAL 9010

V16 ● manganese S051

V26 ● black RAL 9005

Cable duct: metal

V1 ○ white RAL 9010

V25 ● yellow RAL 1006

V26 ● black RAL 9005

art.3H200H900 XM3B

art.3H200H900 XM1G

art.3H200H900 XM1N

DESIGN 967 ARCH



Front

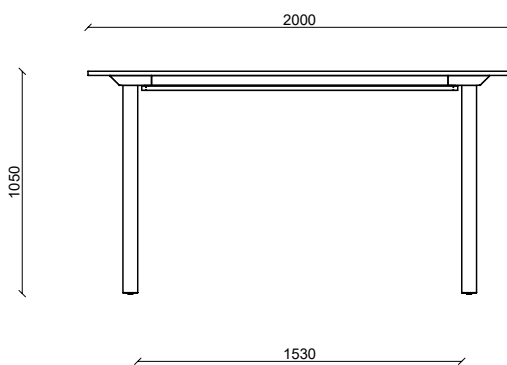

Side

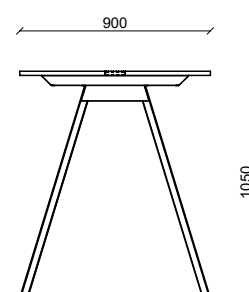

T-Share

MADE IN ITALY

T-Share Table Meeting

W 2000 mm x D 900 mm x H 1050 mm

DESIGN 967 ARCH

DESCRIPTION	T-Share Table Meeting	COLORS	Structure COLORS > Available in 2 standard colors: V1 white (RAL 9010) V16 Manganese Cable duct COLORS > Available in 3 standard colors: V25 Yellow (RAL 1006) V26 Black (RAL 9005) V1 White (RAL 9010) Top COLORS > Fenix available in 3 standard colors: FX1 white (Malè); FX2 grey (Efeso); FX3 grey (London) > MDF Perfect Sense available in 3 standard colors: D1 matt white; D2 warm grey; D3 matt black > Melamine available in 3 standard colors: M1 white; M2 light grey; MW1 maple > Standard semi-gloss colors > Customizable colors available upon request and with an extra charge: www.dieffebi.com/docs/299/2832/DFB_Colour-Chart-2020.pdf
EXTERNAL DIMENSIONS	W 2000 mm x D 900 mm x H 1050 mm	ACCESSORIES	> Front dividing panel in fabric > Side divider panel in fabric
PRODUCTION	> Dieffebi S.p.a. > Start of production: 2019 > Country of production: Italy	NET WEIGHT	72,00 Kg
MATERIALS	> Structure in recycled and recyclable metal > Fenix top: high resistance to scratches and heat, anti-fingerprint, softness to the touch, low light reflection, thermal repairability of micro-scratches, high bacterial reduction activity > PerfectSense MDF top: in Premium Matt, it stands out from other furniture surfaces for its visual and tactile characteristics. The special anti-fingerprint property reduces the formation of fingerprints on the surface and makes cleaning much easier. The trendy design, warm and velvety to the touch, invites you to touch the surface > Melamine: ecological chipboard panel made from recycled wood. The melamine surfaces are resistant and hygienic and do not require any particular maintenance	MAINTENANCE	> Clean with a soft cloth > Do not treat the surfaces with abrasive cloths
FINISHING STRUCTURE	> Low-emission powder coating (material inert) > Free from heavy metals > Absence of sharp edges and cutting edges > Anti-glare finish > It does not contain VOCs	PACKAGING	> volume: 0,68 m ³ > Packed in cardboard box > Supplied disassembled > Packages: 7
STANDARD COMPONENTS	> Top Access (2) in painted aluminium with double door and cable retaining bristles > Cable collection channel painted in the same color > Leg cover to cover the power cable passage > Adjustable feet H 10 mm > Assembly screws	END OF USE	> Equipped with disassembly card for disposal
		WARRANTY	> Dieffebi guarantees that the product was made using high quality materials - See warranty document

T-Share

MADE IN ITALY

T-Share Table Meeting

W 2000 mm x D 900 mm x H 1050 mm

DESIGN 967ARCH

WELLNESS AND ENVIRONMENT > Green design in accordance with LEED® standards, to design and furnish environments with a high sustainability content



FINISHING TEST UNI EN ISO 2409:2013
METAL NSS UNI EN ISO 9227:2017
STRUCTURE UNI EN 15187:2007EN ISO 1520:2006
 UNI EN ISO 6272-1:2013
 UNI EN 15185:2011
 UNI EN 15186:2012, met.B
 UNI 9300:2015
 EN 12720:2013
 EN 12721:2013
 UNI 9429:2015

CLASS OF > Frame: Class 0
REACTION TO FIRE > Top: Class s1,d0



ADIMEMBER



T-Share

Varnish
Vernici
Vernis
Lacke

Frame
Struttura
Piètement
Gestell



-V1
S711 (RAL 9010)
Pure white



-V16
S051
Manganese



-V26
S885 (RAL 9005)
Black opaco

Cable duct
Canalina
Goulotte pour
câblage
Kabelwanne



-V4
S708 (RAL 9010)
Pure white textured finish



-V25
S107 (RAL 1006)
Yellow



-V26
S885 (RAL 9005)
Black opaco

Fenix

Top
Piano
Plateau
Tischplatte

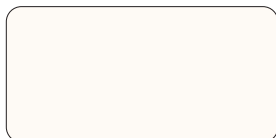

-FX1
Bianco/White /Blanc/Weiß – Malè



-FX2
Grigio/Grey/Gris/Grau – Efeso



-FX3
Grigio/Grey/Gris/Grau – London

MDF Perfect Sense

Top
Piano
Plateau
Tischplatte



-D1
Bianco opaco/Matt White
/Blanc mat/Matt weiß



-D2
Grigio caldo/Warm grey
/Gris chaud/Warmes Grau



-D3
Nero opaco/Matt black
/Noir mat/Mattschwarz

T-Share

Melamine
Melaminico
Mélaminé
Melamin

Top
Piano
Plateau
Tischplatte

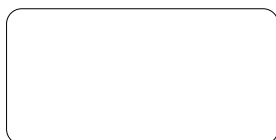

-M1
Bianco/White/Blanc/Weiß



-M2
Grigio chiaro/Light grey
/Gris clair/Hellgrau



-MW1
Acero/Maple/Érable/Ahorn

Fabrics
Tessuti
Tissus
Textilien

Fabric acoustic panel
complete
with magnetic support
Pannello acustico
completo
di supporto magnetico
Panneau acoustique
avec support magnétique
Stoffbezogene
Akustikplatte mit
magnetischer
Unterstützung



- TP7
Caimi
Bianco Ghiaccio 8002



- TP8
Caimi
Giallo 3008



- TP9
Caimi
Nero 8033

T-Share

MADE IN ITALY

T-Share Double Table Operative

W 4400 mm x D 1300 mm x H 740 mm

Top: Fenix
 FX1 ○ white Malè
 FX2 ● grey Efeso
 FX3 ● grey London

Frame: metal
 V1 ○ white RAL 9010
 V16 ● manganese S051
 V16 ● manganese S051

Cable duct: metal
 V26 ● black RAL 9005
 V25 ● yellow RAL 1006
 V25 ● yellow RAL 1006

art.3HK204400 XBBN
 art.3HK204400 XGAF
 art.3HK204400 XGAC

Top: MDF Perfect Sense
 D1 ○ matt white
 D2 ● warm grey
 D3 ● matt black

Frame: metal
 V1 ○ white RAL 9010
 V16 ● manganese S051
 V26 ● black RAL 9005

Cable duct: metal
 V1 ○ white RAL 9010
 V25 ● yellow RAL 1006
 V26 ● black RAL 9005

art.3HK204400 XM2C
 art.3HK204400 XM3A
 art.3HK204400 XM3N

Top: melamine
 M1 ○ white
 M2 ● light grey
 MW1 ● maple

Frame: metal
 V1 ○ white RAL 9010
 V16 ● manganese S051
 V26 ● black RAL 9005

Cable duct: metal
 V1 ○ white RAL 9010
 V25 ● yellow RAL 1006
 V26 ● black RAL 9005

art.3HK204400 XM3B
 art.3HK204400 XM1G
 art.3HK204400 XM1N

DESIGN 967 ARCH

Front

Side

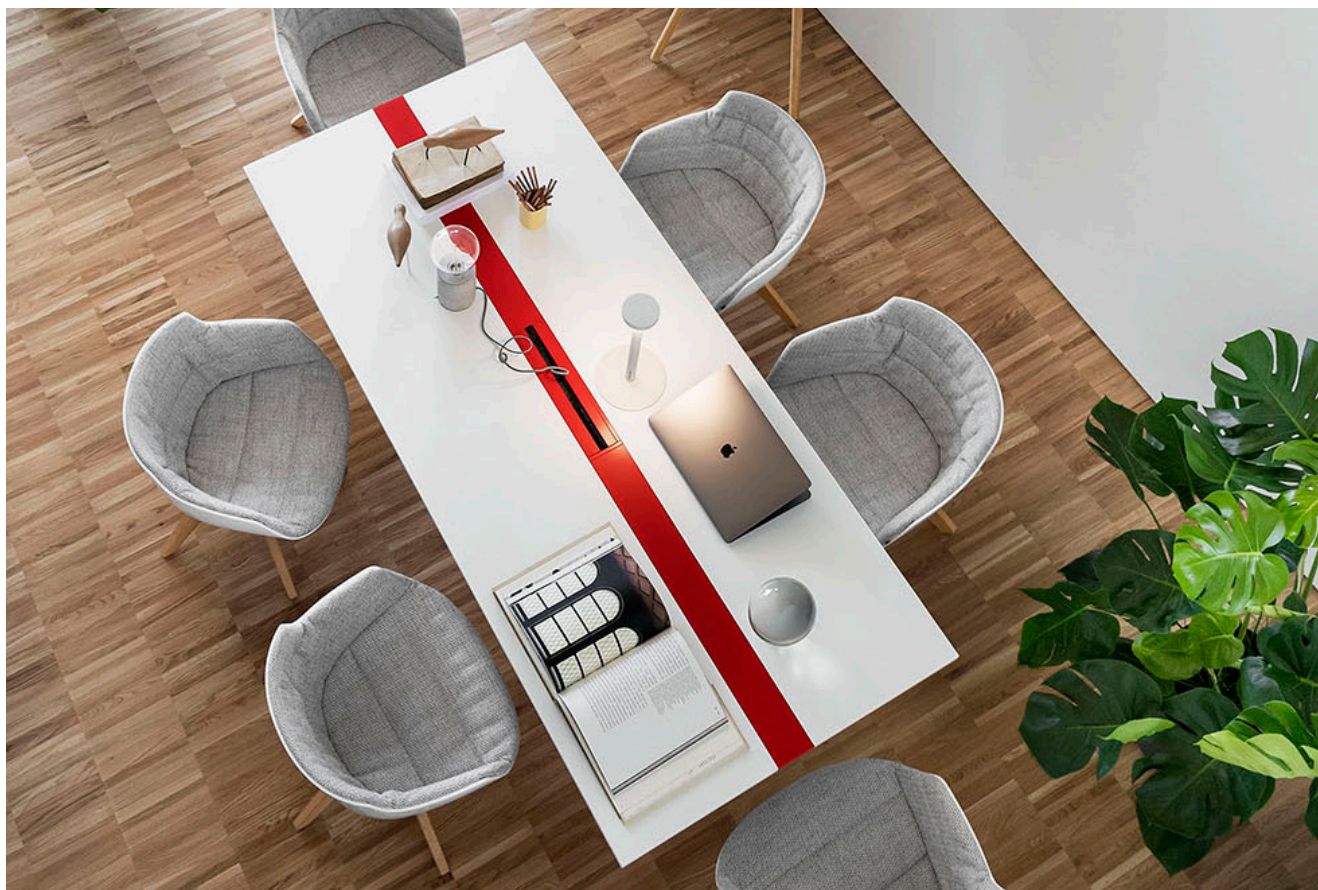
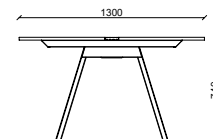
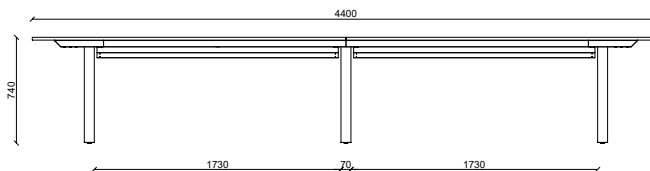
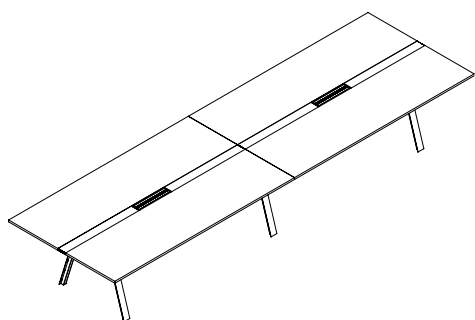

T-Share

MADE IN ITALY

T-Share Double Table Operative

W 4400 mm x D 1300 mm x H 740 mm

DESIGN 967 ARCH

DESCRIPTION	T-Share Double Table Operative	COLORS	Structure COLORS > Available in 2 standard colors: V1 white (RAL 9010) V16 Manganese Cable duct COLORS > Available in 3 standard colors: V25 Yellow (RAL 1006) V26 Black (RAL 9005) V1 White (RAL 9010) Top COLORS > Fenix available in 3 standard colors: FX1 white (Malè); FX2 grey (Efeso); FX3 grey (London) > MDF Perfect Sense available in 3 standard colors: D1 matt white; D2 warm grey; D3 matt black > Melamine available in 3 standard colors: M1 white; M2 light grey; MW1 maple > Standard semi-gloss colors > Customizable colors available upon request and with an extra charge: www.dieffebi.com/docs/299/2832/DFB_Colour-Chart-2020.pdf
EXTERNAL DIMENSIONS	W 4400 mm x D 1300 mm x H 740 mm	ACCESSORIES	> Front dividing panel in fabric > Side divider panel in fabric
PRODUCTION	> Dieffebi S.p.a. > Start of production: 2019 > Country of production: Italy	NET WEIGHT	182,00 Kg
MATERIALS	> Structure in recycled and recyclable metal > Fenix top: high resistance to scratches and heat, anti-fingerprint, softness to the touch, low light reflection, thermal repairability of micro-scratches, high bacterial reduction activity > PerfectSense MDF top: in Premium Matt, it stands out from other furniture surfaces for its visual and tactile characteristics. The special anti-fingerprint property reduces the formation of fingerprints on the surface and makes cleaning much easier. The trendy design, warm and velvety to the touch, invites you to touch the surface > Melamine: ecological chipboard panel made from recycled wood. The melamine surfaces are resistant and hygienic and do not require any particular maintenance	MAINTENANCE	> Clean with a soft cloth > Do not treat the surfaces with abrasive cloths
FINISHING STRUCTURE	> Low-emission powder coating (material inert) > Free from heavy metals > Absence of sharp edges and cutting edges > Anti-glare finish > It does not contain VOCs	PACKAGING	> volume: 1,1 m ³ > Packed in cardboard box > Supplied disassembled > Packages: 15
STANDARD COMPONENTS	> Top Access (2) in painted aluminium with double door and cable retaining bristles > Cable collection channel painted in the same color > Leg cover to cover the power cable passage > Adjustable feet H 10 mm > Assembly screws	END OF USE	> Equipped with disassembly card for disposal
		WARRANTY	> Dieffebi guarantees that the product was made using high quality materials - See warranty document

T-Share

MADE IN ITALY

T-Share Double Table Operative

W 4400 mm x D 1300 mm x H 740 mm

DESIGN 967ARCH

WELLNESS AND ENVIRONMENT > Green design in accordance with LEED® standards, to design and furnish environments with a high sustainability content



www.GreenTop.com



FINISHING TEST UNI EN ISO 2409:2013
METAL NSS UNI EN ISO 9227:2017
STRUCTURE UNI EN 15187:2007EN ISO 1520:2006
 UNI EN ISO 6272-1:2013
 UNI EN 15185:2011
 UNI EN 15186:2012, met.B
 UNI 9300:2015
 EN 12720:2013
 EN 12721:2013
 UNI 9429:2015

CLASS OF > Frame: Class 0
REACTION TO FIRE > Top: Class s1,d0



dieffebi



MADE IN EUROPE

ASSUFFICIO
ASSOCIAZIONE FIDELIENEGARRECO

ADIMEMBER



consip
 acquistinretepa.it
Il Fornitore Aggiunto della Pubblica Amministrazione

Dieffebi SpA

via Palù 36
 San Vendemiano,
 31020 Treviso - Italia

T +39 0438 4715
 F +39 0438 471600
 exportsales@dieffebi.com
 vendite@dieffebi.com
 www.dieffebi.com

T-Share

Varnish
Vernici
Vernis
Lacke

Frame
Struttura
Piètement
Gestell



-V1
S711 (RAL 9010)
Pure white



-V16
S051
Manganese



-V26
S885 (RAL 9005)
Black opaco

Cable duct
Canalina
Goulotte pour
câblage
Kabelwanne



-V4
S708 (RAL 9010)
Pure white textured finish



-V25
S107 (RAL 1006)
Yellow



-V26
S885 (RAL 9005)
Black opaco

Fenix

Top
Piano
Plateau
Tischplatte

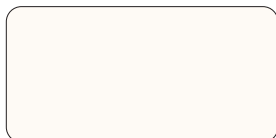

-FX1
Bianco/White /Blanc/Weiß – Malè



-FX2
Grigio/Grey/Gris/Grau – Efeso



-FX3
Grigio/Grey/Gris/Grau – London

MDF Perfect Sense

Top
Piano
Plateau
Tischplatte



-D1
Bianco opaco/Matt White
/Blanc mat/Matt weiß



-D2
Grigio caldo/Warm grey
/Gris chaud/Warmes Grau



-D3
Nero opaco/Matt black
/Noir mat/Mattschwarz

T-Share

Melamine
Melaminico
Mélaminé
Melamin

Top
Piano
Plateau
Tischplatte



-M1
Bianco/White/Blanc/Weiß



-M2
Grigio chiaro/Light grey
/Gris clair/Hellgrau



-MW1
Acero/Maple/Érable/Ahorn

Fabrics
Tessuti
Tissus
Textilien

Fabric acoustic panel
complete
with magnetic support
Pannello acustico
completo
di supporto magnetico
Panneau acoustique
avec support magnétique
Stoffbezogene
Akustikplatte mit
magnetischer
Unterstützung



- TP7
Caimi
Bianco Ghiaccio 8002



- TP8
Caimi
Giallo 3008



- TP9
Caimi
Nero 8033

T-Share

MADE IN ITALY

T-Share Triple Table Meeting/Operative

W 6600 mm x D 1300 mm x H 740 mm

Top: Fenix
 FX1 ○ white Malè
 FX2 ● grey Efeso
 FX3 ● grey London

Frame: metal
 V1 ○ white RAL 9010
 V16 ● manganese S051
 V16 ● manganese S051

Cable duct: metal
 V26 ● black RAL 9005
 V25 ● yellow RAL 1006
 V25 ● yellow RAL 1006

art.3HK306600 XBBN
 art.3HK306600 XGAF
 art.3HK306600 XGAC

Top: MDF Perfect Sense
 D1 ○ white
 D2 ● warm grey
 D3 ● matt black

Frame: metal
 V1 ○ white RAL 9010
 V16 ● manganese S051
 V26 ● black RAL 9005

Cable duct: metal
 V1 ○ white RAL 9010
 V25 ● yellow RAL 1006
 V26 ● black RAL 9005

art.3HK306600 XM2C
 art.3HK306600 XM3A
 art.3HK306600 XM3N

Top: melamine
 M1 ○ white
 M2 ● light grey
 MW1 ● maple

Frame: metal
 V1 ○ white RAL 9010
 V16 ● manganese S051
 V26 ● black RAL 9005

Cable duct: metal
 V1 ○ white RAL 9010
 V25 ● yellow RAL 1006
 V26 ● black RAL 9005

art.3HK306600 XM3B
 art.3HK306600 XM1G
 art.3HK306600 XM1N

DESIGN 967 ARCH

Front

Side

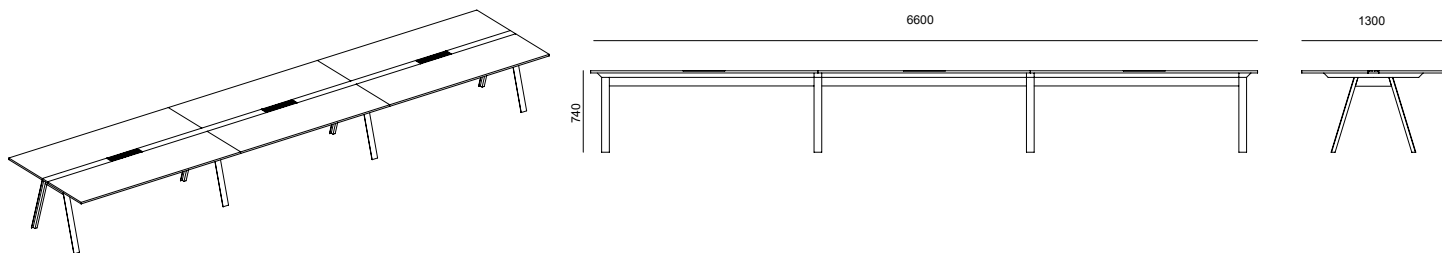

T-Share

MADE IN ITALY

T-Share Triple Table Meeting/Operative

W 6600 mm x D 1300 mm x H 740 mm

DESIGN 967 ARCH

DESCRIPTION	T-Share Triple Table Meeting/Operative	COLORS	Structure COLORS > Available in 2 standard colors: V1 white (RAL 9010) V16 Manganese Cable duct COLORS > Available in 3 standard colors: V25 Yellow (RAL 1006) V26 Black (RAL 9005) V1 White (RAL 9010) Top COLORS > Fenix available in 3 standard colors: FX1 white (Malè); FX2 grey (Efeso); FX3 grey (London) > MDF Perfect Sense available in 3 standard colors: D1 matt white; D2 warm grey; D3 matt black > Melamine available in 3 standard colors: M1 white; M2 light grey; MW1 maple > Standard semi-gloss colors > Customizable colors available upon request and with an extra charge: www.dieffebi.com/docs/299/2832/DFB_Colour-Chart-2020.pdf
EXTERNAL DIMENSIONS	W 6600 mm x D 1300 mm x H 740 mm	ACCESSORIES	> Front dividing panel in fabric > Side divider panel in fabric
PRODUCTION	> Dieffebi S.p.a. > Start of production: 2019 > Country of production: Italy	NET WEIGHT	270,00 Kg
MATERIALS	> Structure in recycled and recyclable metal > Fenix top: high resistance to scratches and heat, anti-fingerprint, softness to the touch, low light reflection, thermal repairability of micro-scratches, high bacterial reduction activity > PerfectSense MDF top: in Premium Matt, it stands out from other furniture surfaces for its visual and tactile characteristics. The special anti-fingerprint property reduces the formation of fingerprints on the surface and makes cleaning much easier. The trendy design, warm and velvety to the touch, invites you to touch the surface > Melamine: ecological chipboard panel made from recycled wood. The melamine surfaces are resistant and hygienic and do not require any particular maintenance	MAINTENANCE	> Clean with a soft cloth > Do not treat the surfaces with abrasive cloths
FINISHING STRUCTURE	> Low-emission powder coating (material inert) > Free from heavy metals > Absence of sharp edges and cutting edges > Anti-glare finish > It does not contain VOCs	PACKAGING	> volume: 1,5 m3 > Packed in cardboard box > Supplied disassembled > Packages: 21
STANDARD COMPONENTS	> Top Access (3) in painted aluminium with double door and cable retaining bristles > Cable collection channel painted in the same color > Leg cover to cover the power cable passage > Adjustable feet H 10 mm > Assembly screws	END OF USE	> Equipped with disassembly card for disposal
		WARRANTY	> Dieffebi guarantees that the product was made using high quality materials - See warranty document

T-Share

MADE IN ITALY

T-Share Triple Table Meeting/Operative

W 6600 mm x D 1300 mm x H 740 mm

DESIGN 967ARCH

WELLNESS AND ENVIRONMENT > Green design in accordance with LEED® standards, to design and furnish environments with a high sustainability content



FINISHING TEST UNI EN ISO 2409:2013
METAL NSS UNI EN ISO 9227:2017
STRUCTURE UNI EN 15187:2007EN ISO 1520:2006
 UNI EN ISO 6272-1:2013
 UNI EN 15185:2011
 UNI EN 15186:2012, met.B
 UNI 9300:2015
 EN 12720:2013
 EN 12721:2013
 UNI 9429:2015

CLASS OF > Frame: Class 0
REACTION TO FIRE > Top: Class s1,d0



ADIMEMBER



T-Share

Varnish
Vernici
Vernis
Lacke

Frame
Struttura
Piètement
Gestell



-V1
S711 (RAL 9010)
Pure white



-V16
S051
Manganese



-V26
S885 (RAL 9005)
Black opaco

Cable duct
Canalina
Goulotte pour
câblage
Kabelwanne



-V4
S708 (RAL 9010)
Pure white textured finish



-V25
S107 (RAL 1006)
Yellow



-V26
S885 (RAL 9005)
Black opaco

Fenix

Top
Piano
Plateau
Tischplatte

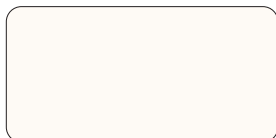

-FX1
Bianco/White /Blanc/Weiß – Malè



-FX2
Grigio/Grey/Gris/Grau – Efeso



-FX3
Grigio/Grey/Gris/Grau – London

MDF Perfect Sense

Top
Piano
Plateau
Tischplatte



-D1
Bianco opaco/Matt White
/Blanc mat/Matt weiß



-D2
Grigio caldo/Warm grey
/Gris chaud/Warmes Grau



-D3
Nero opaco/Matt black
/Noir mat/Mattschwarz

T-Share

Melamine
Melaminico
Mélaminé
Melamin

Top
Piano
Plateau
Tischplatte

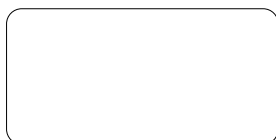

-M1
Bianco/White/Blanc/Weiß



-M2
Grigio chiaro/Light grey
/Gris clair/Hellgrau



-MW1
Acero/Maple/Érable/Ahorn

Fabrics
Tessuti
Tissus
Textilien

Fabric acoustic panel
complete
with magnetic support;
Pannello acustico
completo
di supporto magnetico;
Panneau acoustique
avec support
magnétique;
Stoffbezogene
Akustikplatte mit
magnetischer
Unterstützung



- TP7
Caimi
Bianco Ghiaccio 8002



- TP8
Caimi
Giallo 3008



- TP9
Caimi
Nero 8033